

AE6/AN-3A

cylindrical inductive



Micro Detectors

Italian Sensors Technology



Indicative image

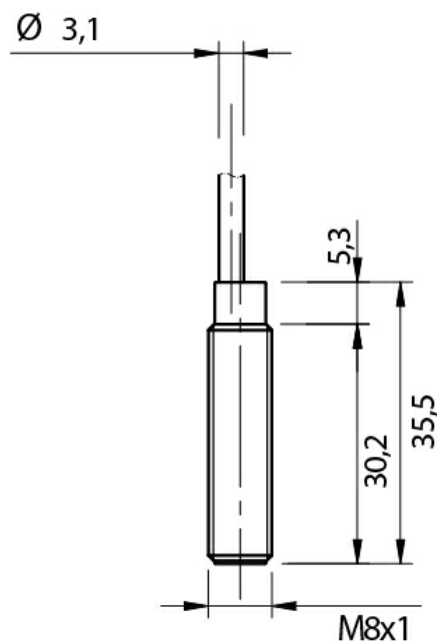

Detection properties

Nominal sensing distance	2mm
Operanting distance	0...1,62mm
Standard target	8x8mm FE360
Correction Factor	copper: 0,35 / aluminium: 0,43 / brass: 0,52 / stainless steel: 0,78
Thermal drift of Sr	< 10%
Repeat Accuracy	5% (UB 24V Ta=23°C ±5°C)
Hysteresis	1 ... 20%

Outputs

Output type	NPN
Output Function	NO
Switching frequency	5kHz

Electrical data

Operating Voltage	10 - 30Vdc
No-Load supply current	≤ 10mA
Load current	≤ 200mA
Leakage current	≤ 10μA
Output voltage drop	≤ 1,8V @200mA
Max ripple content	≤10%
LED indicators	Yellow LED output state
Time delay before availability	50ms
Short-circuit protection	Yes
Reverse Polarity Protection	Yes
Protection against inductive loads	Yes

Mechanical data

Dimensions	M8 x 1 / L = 35,5mm
Mounting	Shielded
Weight	45g
Housing Material	Nickel-plated brass
Connections	2m PVC Cable
Active Head Material	PBT
Tightening torque	3Nm
Operating temperature	-25°C...+70°C

Test/Approvals

Approvals	CE UR
EMC compatibility	IEC 60947-5-2
Shocks and vibrations	Vibration IEC 60068-2-6 / Shock IEC 60068-2-27
Degree of protection	IP 67 (EN60529)

Accessories

Supplied Accessories	2 nuts M8x1
----------------------	-------------

ELECTRICAL DIAGRAMS OF THE CONNECTIONS

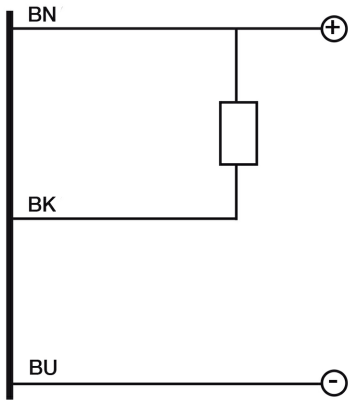

INSTALLATION

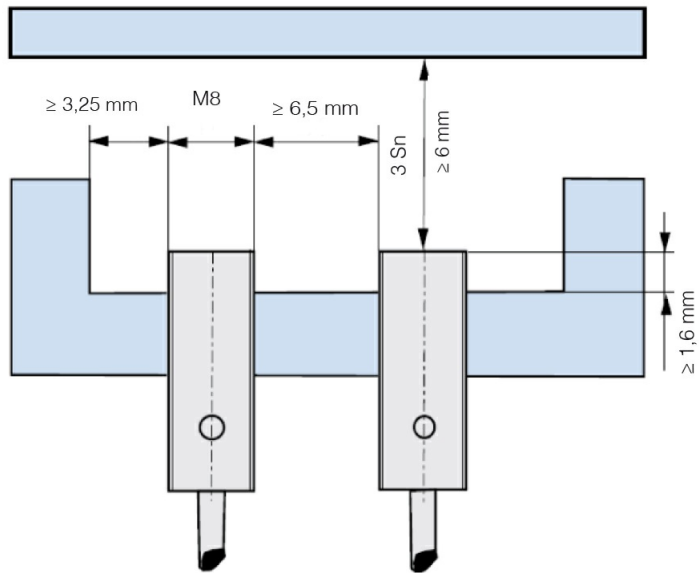

RESPONSE CURVES

Disassamento Parallelo

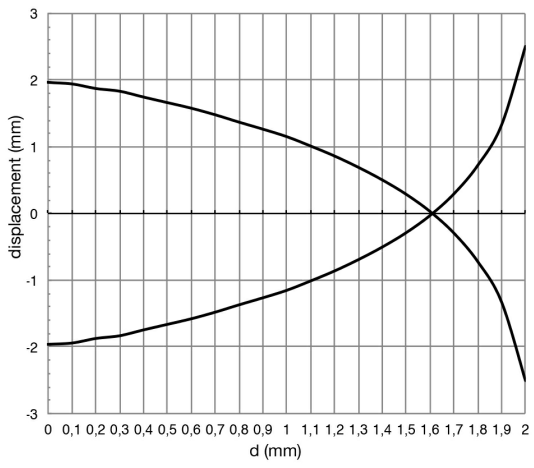

M.D.Micro Detectors S.p.A.

Strada S.Caterina, 235

41122 Modena (MO)

Tel. 059 420411

Fax 059 253973

E-mail info@microdetectors.com

date of printing

03/07/2019 15:55:23