

Sensori di prossimità induttivi M18 serie PFK per applicazioni alimentari

*M18 proximity inductive sensors
PFK series for food and beverage
applications*



Caratteristiche principali Main features

- > Corpo in acciaio inox AISI 316L (DIN 1.4404)
- > *AISI 316L (DIN 1.4404) stainless steel housing*
- > Indicatore LED
- > *LED status indicator*
- > Grado di protezione IP67 – IP68 – IP69K
- > *IP67 – IP68 – IP69K protection degree*
- > Totalmente protetti contro danneggiamenti di tipo elettrico
- > *Complete protection against electrical damages*
- > Modelli distanza standard e lunga distanza
- > *Standard and long distance models*
- > Marchio
- > *CE Mark*

Descrizione del codice - Code structure

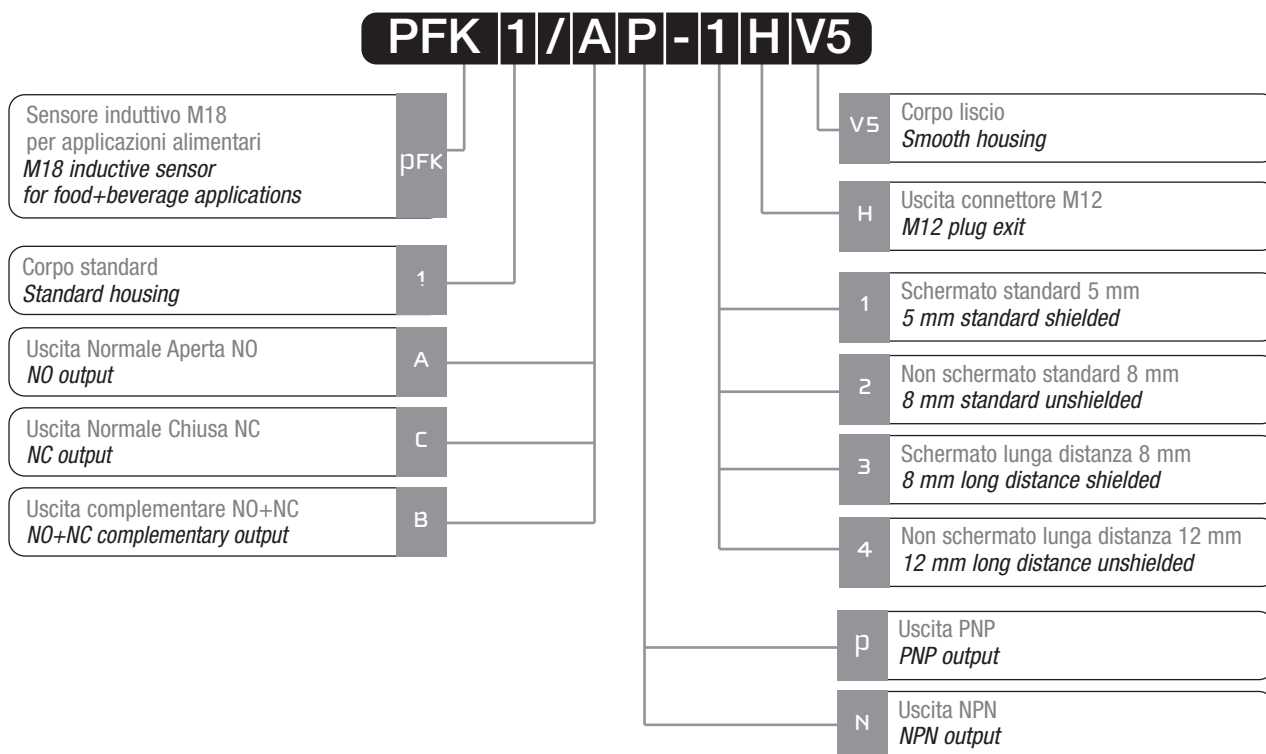

Modelli disponibili - Available models

> Modelli Standard - Standard Models

Diametro Model	Montaggio Installation	Portata Sensing	Uscita Output	Distanza Distance	NPN-NO	PNP-NO
M18	Schermato <i>Shielded</i>	Standard	M12	5 mm	PFK1/AN-1H	PFK1/AP-1H
	Non schemato <i>Unshielded</i>	Standard	M12	8 mm	PFK1/AN-2H	PFK1/AP-2H
	Schermato <i>Shielded</i>	Lunga dist. <i>Long dist.</i>	M12	8 mm	PFK1/AN-3H	PFK1/AP-3H
	Non schemato <i>Unshielded</i>	Lunga dist. <i>Long dist.</i>	M12	12 mm	PFK1/AN-4H	PFK1/AP-4H

> Modelli con uscita complementare - Models with complementary output

Diametro Model	Montaggio Installation	Portata Sensing	Uscita Output	Distanza Distance	NPN NO + NC	PNP NO + NC
M18	Schermato <i>Shielded</i>	Standard	M12	5 mm	PFK1/BN-1H	PFK1/BP-1H
	Non schemato <i>Unshielded</i>	Standard	M12	8 mm	PFK1/BN-2H	PFK1/BP-2H
	Schermato <i>Shielded</i>	Lunga dist. <i>Long dist.</i>	M12	8 mm	PFK1/BN-3H	PFK1/BP-3H
	Non schemato <i>Unshielded</i>	Lunga dist. <i>Long dist.</i>	M12	12 mm	PFK1/BN-4H	PFK1/BP-4H

Codici di classe C / C class codes

N.B. I prodotti di classe C possono presentare limitazioni nei termini di consegna o sui quantitativi ordinabili

Note: The class C products could be subject to delays in delivery terms or limits for the quantities to be ordered

Specifiche (In accordo con IEC EN 60947-5-2 / DIN 44030) - Specifications (According to IEC EN 60947-5-2 / DIN 44030)

Modello / Model	PFK1/**-1H	PFK1/**-2H	PFK1/**-3H	PFK1/**-4H
Distanza nominale / Rated operating distance <i>S_n</i>	5 mm	8 mm	8 mm	12 mm
Corsa differenziale / Hysteresis		1 ÷ 20%		
Dimensione azionatore normalizzato / Standard target	18x18 mm Fe360	24x24 mm Fe360		36x36 mm Fe360
Ripetibilità / Repeat accuracy @ UB 20-30 V Ta = 23°C ± 5°C		5%		
Campo di tensione di alimentazione Supply voltage range		10 ÷ 30Vcc		
Massima ondulazione residua / Max ripple content		≤ 10%		
Corrente di uscita / Output current		≤ 200 mA		
Tensione di saturazione di uscita / Output voltage drop		≤ 2V		
Corrente di alimentazione senza carico No load supply current		≤ 15 mA		
Corrente di perdita / Leakage current		≤ 10 µA		
Frequenza di commutazione / Switching frequency		1,5 kHz		
Ritardo all'accensione / Time delay before availability		50 ms		
Campo di temperature ambiente Ambient temperature range		-40 ÷ +80 °C, breve esposizione (15') a 100°C (durante processi di igienizzazione) short exposure (15') to 100°C (during cleaning processes)		
Deriva termica di <i>S_r</i> / Temperature drift of <i>S_r</i>		10%		
Protezione al corto circuito / Short-circuit protection		Si autoripristinante / Yes auto reset		
Protezione all'inversione di polarità di alimentazione Voltage reversal protection		Si / Yes		
Protezione ai carichi induttivi / Induction protection		Si / Yes		
Colpi e vibrazioni / Shocks and vibration		IEC EN60947-5-2 / §7.4		
Peso / Weight		35g		
Indicatori LED / LED indicators		Uscita NO / NO output state		
Grado di protezione / Degree of protection		IP67, IP68 (1m, 7 giorni / days); IP69K (secondo / according to DIN 40050 part 9)		
Protezione EMC / EMC protection:		secondo / according to IEC EN60947-5-2		
IEC 60255-5		1 kV		
IEC 61000-4-2		Livello / Level 3 aria / air 8 kV		
IEC 61000-4-3		Livello / Level 3 10 V/m		
IEC 61000-4-4		Livello / Level 3 2 kV		
Materiale del corpo / Housing material		Acciaio inox / Stainless Steel AISI316L (DIN 1.4404)		
Superficie sensibile / Sensing face		PPS (FDA certificato / certified)		
Connessione / Connection		Connettore M12 con contatti dorati / M12 plug with gold-plated pins		
Coppia di serraggio / Tightening torque		107 Nm		

Coefficienti di riduzione - Correction factors

Code Codice	Acciaio Steel FE 360	Rame Copper	Alluminio Aluminum	Ottone Brass	Acciaio INOX Stainless steel
PFK1/**-1*	1	0.25	0.35	0.4	0.7
PFK1/**-2*	1	0.27	0.35	0.42	0.7
PFK1/**-3*	1	0.2	0.3	0.4	0.65
PFK1/**-4*	1	0.3	0.38	0.42	0.65

Tolleranza ±10% / Tolerance ±10%

Schemi elettrici delle connessioni - Electrical diagrams of the connections

PNP – NO o/or NC

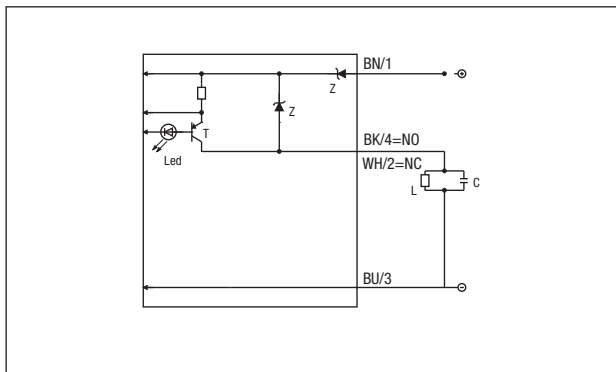

NPN – NO o/or NC

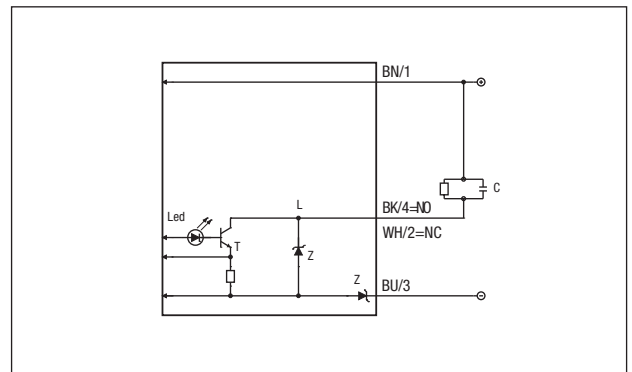

PNP – NO + NC

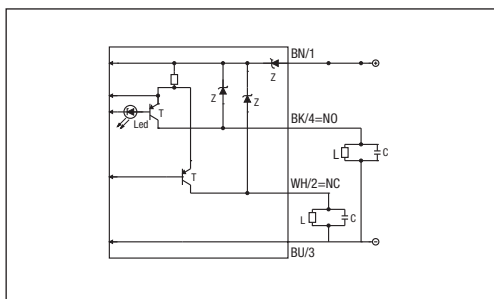

NPN – NO + NC

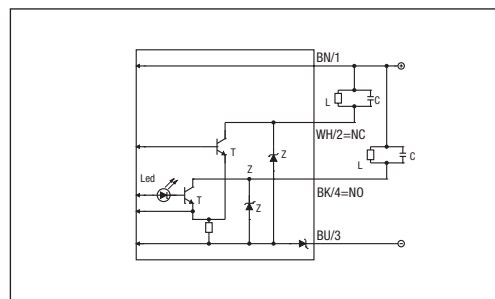

Legenda Key

- BN → marrone/brown
- BK → nero/black
- PK → rosa/pink
- BU → blu/blue
- WH → bianco/white
- GY → grigio/gray

Connettore - Plug

> M12

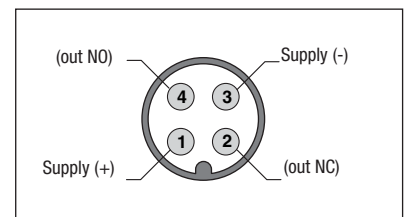
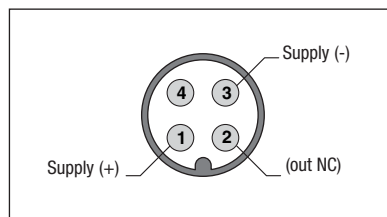
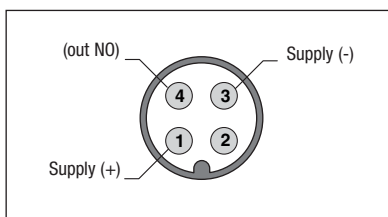

Curva di risposta - Response diagram

PFK1/**-1H

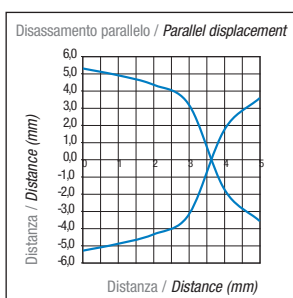

PFK1/**-2H

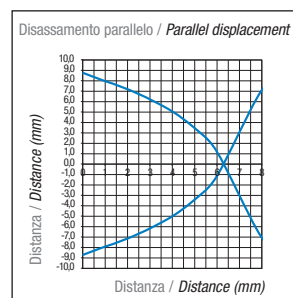

PFK1/**-3H

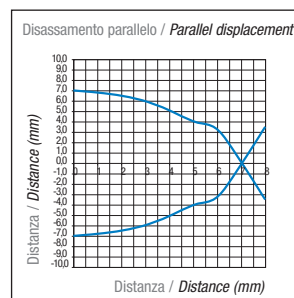

PFK1/**-4H

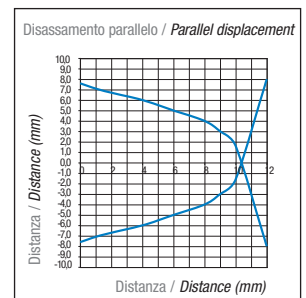

Montaggio - Installation

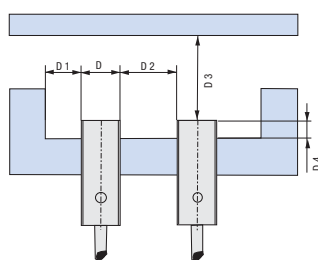

	D4	D1	D2	D3
PFK/**-1*	≥ 3,6 mm	≥ 9 mm	≥ 18 mm	≥ 15 mm
PFK/**-2*	≥ 12 mm	≥ 18 mm	≥ 36 mm	≥ 24 mm
PFK/**-3*	≥ 1,8 mm ⁽¹⁾	≥ 9 mm	≥ 18 mm	≥ 24 mm
PFK/**-4*	≥ 16 mm	≥ 18 mm	≥ 36 mm	≥ 36 mm

(1) ≥ 5.4 mm per materiali non magnetici / for non magnetic material

Dimensioni - Dimensions

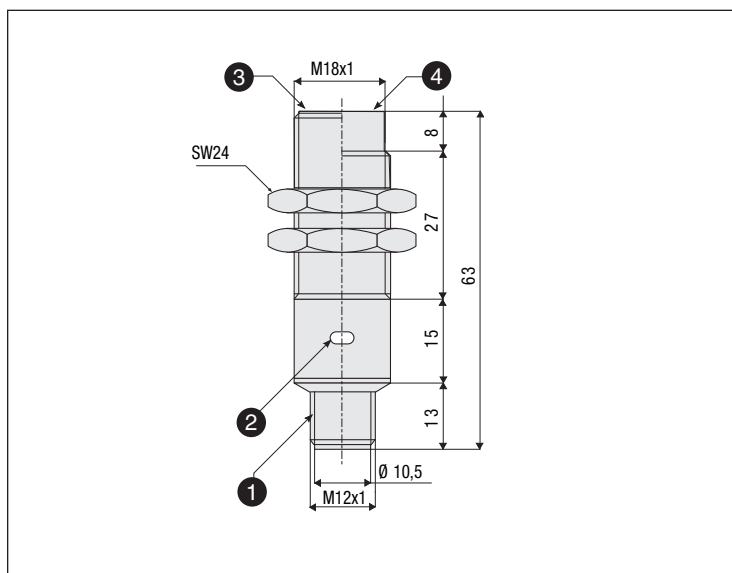

Legenda / Key

- ① Uscita connettore M12
M12 plug cable exit
- ② LED indicatore di stato (uscita NO eccitata)
LED status indicator (NO output energized)
- ③ Versione schermata
Shielded version
- ④ Versione non schermata
Unshielded version