

IL1/AN-4A

cubic inductive



Micro Detectors

Italian Sensors Technology



Indicative image

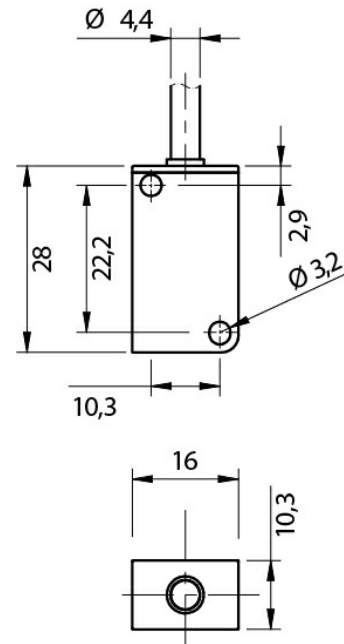

Detection properties

Nominal sensing distance	6mm
Operanting distance	0...4,8mm
Standard target	12x12mm FE360
Correction Factor	copper: 0,41 / aluminium: 0,50 / brass: 0,55 / stainless steel: 0,75
Thermal drift of Sr	< 10%
Repeat Accuracy	5% (UB 24V Ta=23°C ±5°C)
Hysteresis	1 ... 20%

Outputs

Output type	NPN
Output Function	NO
Switching frequency	3kHz

Electrical data

Operating Voltage	10 - 30Vdc
No-Load supply current	≤ 10mA
Load current	≤ 300mA
Leakage current	≤ 0,12mA
Output voltage drop	≤ 1,5V @100mA
Max ripple content	≤10%
LED indicators	Yellow LED output state
Time delay before availability	≤ 100ms
Short-circuit protection	Yes
Reverse Polarity Protection	Yes
Protection against inductive loads	Yes

Mechanical data

Dimensions	28 x 16 x 10,3
Mounting	Shielded
Weight	63g
Housing Material	PA
Connections	2m PVC Cable
Active Head Material	PA
Operating temperature	-25°C...+70°C

Test/Approvals

Approvals	CE
EMC compatibility	IEC 60947-5-2
Shocks and vibrations	Vibration IEC 60068-2-6 / Shock IEC 60068-2-27
Degree of protection	IP 67 (EN60529)

ELECTRICAL DIAGRAMS OF THE CONNECTIONS

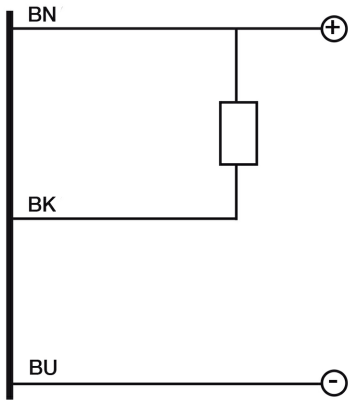

INSTALLATION

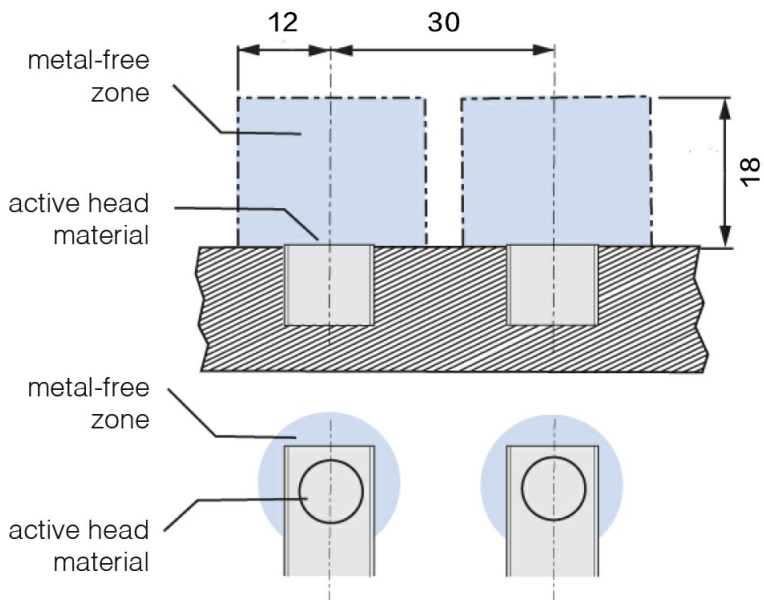

RESPONSE CURVES

Disassamento Parallelo

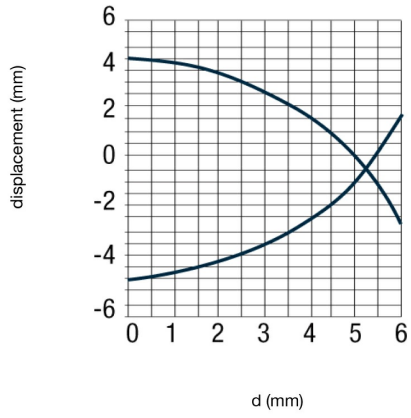

M.D. Micro Detectors S.p.A.

Strada S. Caterina, 235

41122 Modena (MO)

Tel. 059 420411

Fax 059 253973

E-mail info@microdetectors.com

date of printing

05/07/2019 11:12:57