

Sensori di prossimità induttivi M12 serie PFM per applicazioni alimentari

*M12 proximity inductive sensors
PFM series for food and beverage applications*



Caratteristiche principali Main features

- > Corpo in acciaio inox AISI 316L (DIN 1.4404)
- > *AISI 316L (DIN 1.4404) stainless steel housing*
- > Indicatore LED
- > *LED status indicator*
- > Grado di protezione IP67 – IP68 – IP69K
- > *IP67 – IP68 – IP69K protection degree*
- > Totalmente protetti contro danneggiamenti di tipo elettrico
- > *Complete protection against electrical damages*
- > Modelli distanza standard e lunga distanza
- > *Standard and long distance models*
- > Marchio
- > *CE Mark*

Descrizione del codice - Code structure

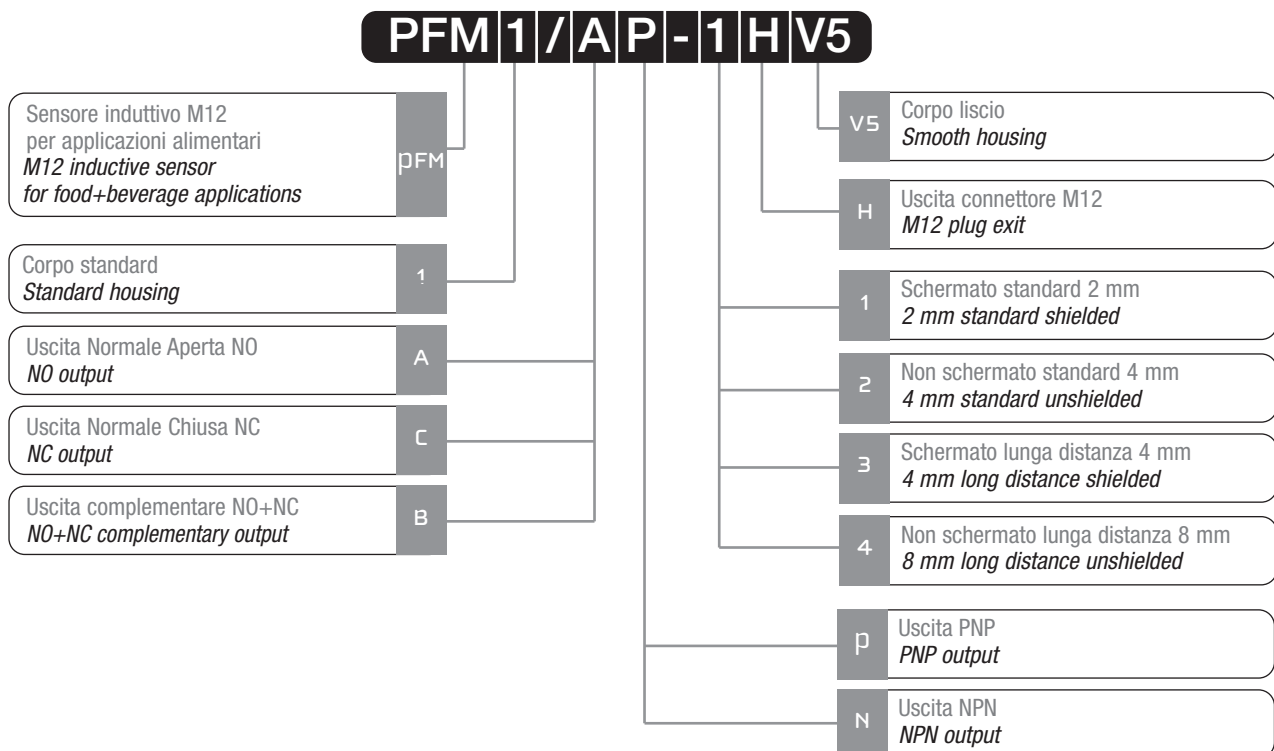

a

PFM SERIES

Modelli disponibili - Available models

> Modelli Standard - Standard Models

Diametro Model	Montaggio Installation	Portata Sensing	Uscita Output	Distanza Distance	NPN-NO	PNP-NO
M12	Schermato <i>Shielded</i>	Standard	M12	2 mm	PFM1/AN-1H	PFM1/AP-1H
	Non schemato <i>Unshielded</i>	Standard	M12	4 mm	PFM1/AN-2H	PFM1/AP-2H
	Schermato <i>Shielded</i>	Lunga dist. <i>Long dist.</i>	M12	4 mm	PFM1/AN-3H	PFM1/AP-3H
	Non schemato <i>Unshielded</i>	Lunga dist. <i>Long dist.</i>	M12	8 mm	PFM1/AN-4H	PFM1/AP-4H

> Modelli con uscita complementare - Models with complementary output

Diametro Model	Montaggio Installation	Portata Sensing	Uscita Output	Distanza Distance	NPN NO + NC	PNP NO + NC
M12	Schermato <i>Shielded</i>	Standard	M12	2 mm	PFM1/BN-1H	PFM1/BP-1H
	Non schemato <i>Unshielded</i>	Standard	M12	4 mm	PFM1/BN-2H	PFM1/BP-2H
	Schermato <i>Shielded</i>	Lunga dist. <i>Long dist.</i>	M12	4 mm	PFM1/BN-3H	PFM1/BP-3H
	Non schemato <i>Unshielded</i>	Lunga dist. <i>Long dist.</i>	M12	8 mm	PFM1/BN-4H	PFM1/BP-4H

Codici di classe C / C class codes

N.B. I prodotti di classe C possono presentare limitazioni nei termini di consegna o sui quantitativi ordinabili

Note: The class C products could be subject to delays in delivery terms or limits for the quantities to be ordered

Specifiche (In accordo con IEC EN 60947-5-2 / DIN 44030) - Specifications (According to IEC EN 60947-5-2 / DIN 44030)

Modello / Model	PFM1/**-1H	PFM1/**-2H	PFM1/**-3H	PFM1/**-4H
Distanza nominale / Rated operating distance <i>S_n</i>	2 mm	4 mm	4 mm	8 mm
Corsa differenziale / Hysteresis		1 ÷ 20%		
Dimensione azionatore normalizzato / Standard target		12x12 mm Fe360		24x24 mm Fe360
Ripetibilità / Repeat accuracy @ UB 20-30 V Ta = 23°C ± 5°C		5%		
Campo di tensione di alimentazione Supply voltage range		10 ÷ 30Vcc		
Massima ondulazione residua / Max ripple content		≤ 10%		
Corrente di uscita / Output current		≤ 200 mA		
Tensione di saturazione di uscita / Output voltage drop		≤ 2V		
Corrente di alimentazione senza carico No load supply current		≤ 15 mA		
Corrente di perdita / Leakage current		≤ 10 µA		
Frequenza di commutazione / Switching frequency		2 kHz		
Ritardo all'accensione / Time delay before availability		50 ms		
Campo di temperature ambiente Ambient temperature range		-40 ÷ +80 °C, breve esposizione (15') a 100°C (durante processi di igienizzazione) short exposure (15') to 100°C (during cleaning processes)		
Deriva termica di <i>S_r</i> / Temperature drift of <i>S_r</i>		10%		
Protezione al corto circuito / Short-circuit protection		Si autoripristinante / Yes auto reset		
Protezione all'inversione di polarità di alimentazione Voltage reversal protection		Si / Yes		
Protezione ai carichi induttivi / Induction protection		Si / Yes		
Colpi e vibrazioni / Shocks and vibration		IEC EN60947-5-2 / §7.4		
Peso / Weight		35 g		
Indicatori LED / LED indicators		Uscita NO / NO output state		
Grado di protezione / Degree of protection		IP67, IP68 (1m, 7 giorni / days); IP69K (secondo / according to DIN 40050 part 9)		
Protezione EMC / EMC protection:		Secondo / According to IEC EN60947-5-2		
	IEC 60255-5	1 kV		
	IEC 61000-4-2	Livello / Level 3 aria / air 8 kV		
	IEC 61000-4-3	Livello / Level 3 10 V/m		
	IEC 61000-4-4	Livello / Level 3 2 kV		
Materiale del corpo / Housing material		Acciaio inox / Stainless Steel AISI316L (DIN 1.4404)		
Superficie sensibile / Sensing face		PPS (FDA certificato / certified)		
Connessione / Connection		Connettore M12 con contatti dorati / M12 plug with gold-plated pins		
Coppia di serraggio / Tightening torque		25 Nm		

Coefficienti di riduzione - Correction factors

Codice Code	Acciaio Steel FE 360	Rame Copper	Alluminio Aluminum	Ottone Brass	Acciaio INOX Stainless steel
PFM1/**-1*	1	0.25	0.3	0.4	0.75
PFM1/**-2*	1	0.33	0.4	0.5	0.8
PFM1/**-3*	1	0.3	0.35	0.4	0.75
PFM1/**-4*	1	0.33	0.4	0.45	0.75

Tolleranza ±10% / Tolerance ±10%

Schemi elettrici delle connessioni - Electrical diagrams of the connections

PNP – NO o/or NC

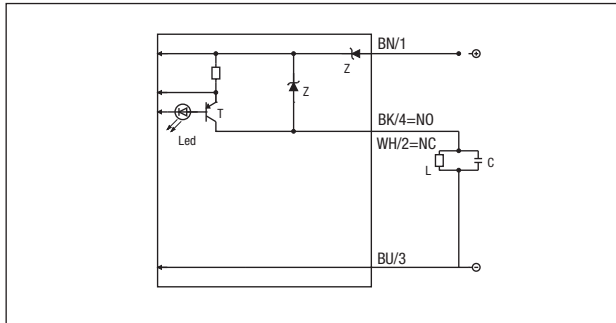

NPN – NO o/or NC

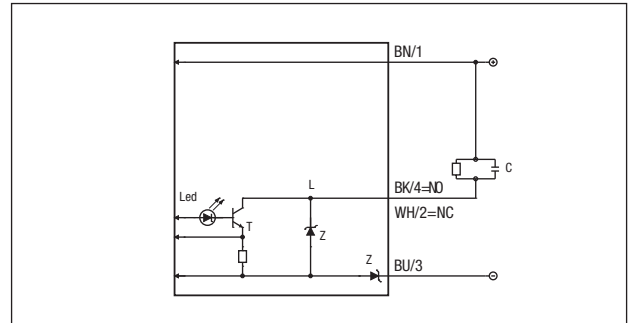

PNP – NO + NC

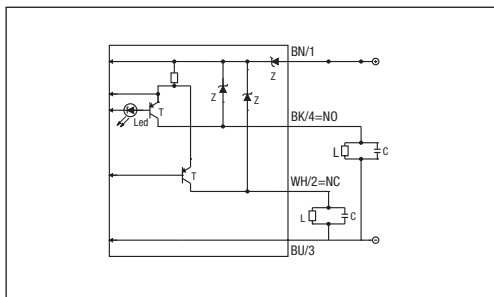

NPN – NO + NC

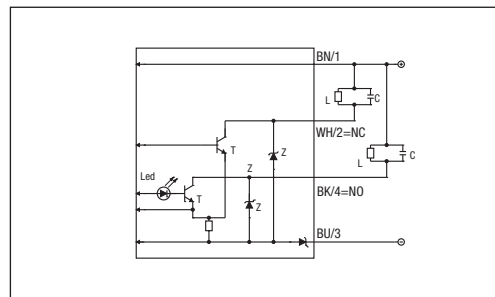

Legenda Key

- BN → marrone/brown
- BK → nero/black
- PK → rosa/pink
- BU → blu/blue
- WH → bianco/white
- GY → grigio/gray

Connettore - Plug

> M12

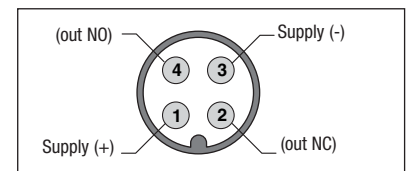
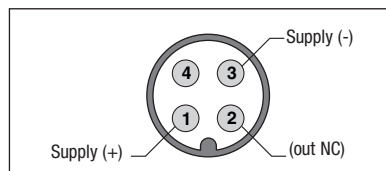
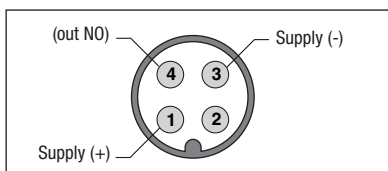

Curva di risposta - Response diagram

PFM1/**-1H

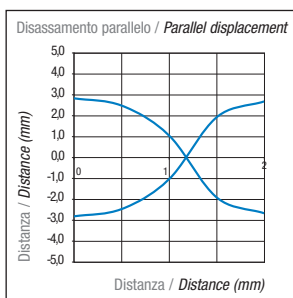

PFM1/**-2H

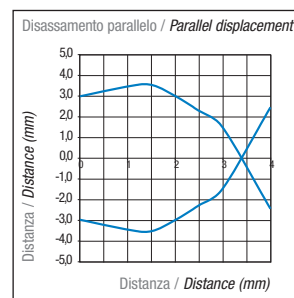

PFM1/**-3H

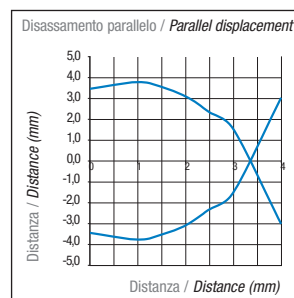

PFM1/**-4H

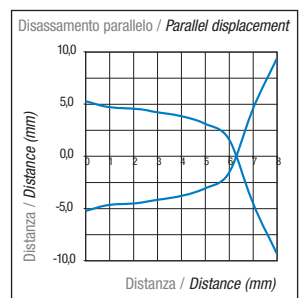

Montaggio - Installation

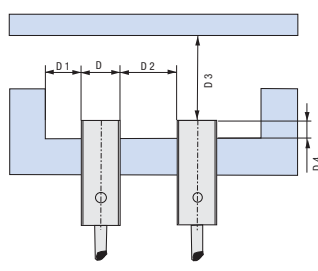

	D4	D1	D2	D3
PFM/**-1*	≥ 0 mm ⁽¹⁾	≥ 6 mm	≥ 12 mm	≥ 6 mm
PFM/**-2*	≥ 6 mm ⁽²⁾	≥ 12 mm	≥ 24 mm	≥ 12 mm
PFM/**-3*	≥ 0 mm ⁽³⁾	≥ 6 mm	≥ 12 mm	≥ 12 mm
PFM/**-4*	≥ 12 mm	≥ 12 mm	≥ 24 mm	≥ 24 mm

- (1) ≥ 2 mm per materiali non magnetici / for non magnetic material
 (2) ≥ 0 mm per materiali non magnetici / for non magnetic material
 (3) ≥ 2.4 mm per materiali non magnetici / for non magnetic material

Dimensioni - Dimensions

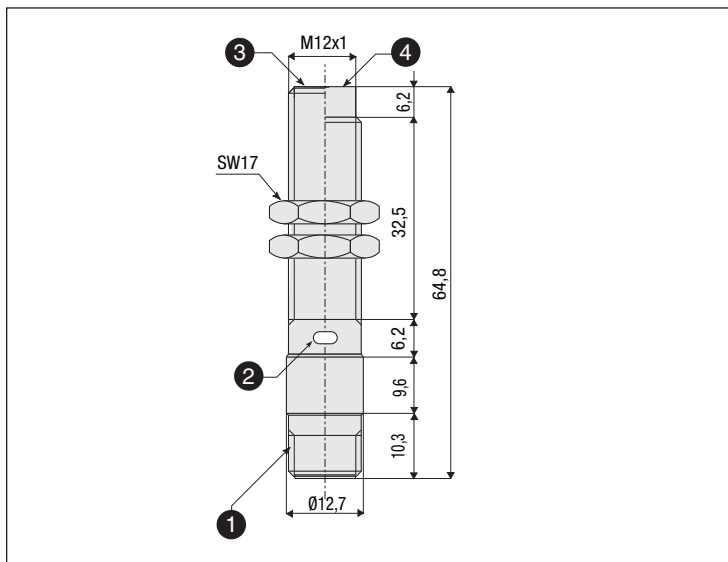

Legenda / Key

- ① Uscita connettore M12
M12 plug cable exit
- ② LED indicatore di stato (uscita NO eccitata)
LED status indicator (NO output energized)
- ③ Versione schermata
Shielded version
- ④ Versione non schermata
Unshielded version