

# YASKAWA

## YASKAWA TÜRKİYE FY18 FİYAT LİSTESİ



### ÖNEMLİ BİLGİLENDİRME

Fiyat Listesi Yaskawa DMC Bölümünün Standart Ürün Portföyünü İçerir.

Fiyat Listesi Uyarı Yapılmaksızın Değişiklik Yapılabilmeye Tabidir.

Teknik Spesifikasyonlar Uyarı Yapılmaksızın Değişiklik Yapılabilmeye Tabidir.

Yaskawa Genel Satınalma Koşullarındaki Maddeler Geçerlidir.

Sadece Pdf Versiyon Fiyat Listesi Geçerlidir.

Stok Ürünler İbaresini Yaskawa Europe Stoklarında Her Zaman Tutulan Ürünleri Simgeler.

Yüksek Satınalma Düzeyi Stok Boşluklarına Sebep Olabilir.

Bu Gibi Durumlarda Stok Garantisi Verilemez.

Tüm Teslim Bilgileri Bilgi Amaçlıdır ve Öngörülemez Şartlardan Dolayı Değişiklik Gösterebilir.

**Teslim: FCA HADIMKÖY (Incoterm 2010)**

**Tarih: 01.06.2018**

<b>MP2600IEC Machine Controller Series</b>	
MP2600IEC Modular Machine Controller	14
Software Tools for MP2600IEC - Version 3	14
Cables and Connectors	14
Servopacks	14
<b>MP2300SIEC/ MP2310IEC Machine Controller Series</b>	
MP2300SIEC / MP2310IEC Motion Controller	15
MP2300SIEC / MP2310IEC Motion Control I/O Option Card	15
Software Tools for MP2300IEC/MP2310IEC - Version 3	15
Cables and Connectors	16
Distributed I/O Module for Mechatrolink II	16
I/O Cable	16
Options	16
<b>MP3200IEC Machine Controller Series</b>	
MP3200IEC High Performance Automation Controller	17
Power Supply Units for MP3200IEC	17
Base Units for MP3200IEC	17
MP3200IEC Motion Control I/O Option Card	17
Software Tools for MP3200IEC - Version 3	17
Mechatrolink III Network Components for MP3200IEC	17
Cables and Connectors	18
Options	18
<b>MP3300IEC Modular Type Machine Controller Series</b>	
MP3300IEC CPU	19
Base Units for MP3300IEC incl. Power Supply	19
MP3300IEC Motion Control I/O Option Card	19
Software Tools for MP3300IEC - Version 3	19
Mechatrolink III Network Components for MP3300IEC	19
Cables and Connectors	20
Options	20
<b>MP2100 Machine Controller Series</b>	
MP Control PC Board for MP2100	21
Software Tools for MP2100	21
Cables and Connectors	21
<b>MP2200 Machine Controller Series</b>	
MP Control Base Units for MP2200	22
MP Control CPU Module for MP2200	22
Connection and Motion Modules for MP2200	22
MP Control Communication Module for MP2200	22
MP2200 Motion Control I/O Option Card	23
Software Tools for MP2200	23
All prices are Inter Company Prices, Incoterm 2010: Free Carrier (FCA) Germany / Idstein or	23
<b>MP2300 / MP2310 / MP2300S Machine Controller Series</b>	
MP Control Basic Module for MP2300/MP2310/MP2300S	23
Motion Modules for MP2300/MP2310/MP2300S	23
MP Control Communication Module for MP2300/MP2310/MP2300S	23
MP2300/MP2310/MP2300S Motion Control I/O Option Card	24
Software Tools for MP2300/2300S/2310	24
Cables and Connectors	24
<b>Mechatrolink 2 I/O Modules &amp; Optional Products</b>	
Distributed I/O Module for Mechatrolink II	25
I/O Cable	25
Options	25
<b>MP3200 Machine Controller Series</b>	
MP3200 High Performance Automation Controller	26
Power Supply Units for MP3200	26
Base Units for MP3200	26
MP3200 Motion Control Modules	26
MP3200 Multiple-CPU Module (MPU-01)	26
MP3200 Motion Control I/O Option Card	26
MP Control Communication Modules for MP3200	26
Software Tools for MP3200	27
Mechatrolink III Network Components for MP3200	27
Cables and Connectors	27

<b>MP3300 Modular Type Machine Controller Series</b>	
MP3300 Modular Machine Controller	28
Base Units for MP3300 incl. Power Supply	28
MP3300 Motion Control Modules	28
MP3300 Multiple-CPU Module (MPU-01)	28
MP3300 Connection Module	28
MP3300 Motion Control I/O Option Modules	28
MP Control Communication Modules for MP3300	28
Mechatrolink III Network Components for MP3300	29
Software Tools for MP3300	29
Cables and Connectors	29
<b>Servopack Sigma 7C Dual Axis Amplifier with build-in Controller Series</b>	
Mechatrolink 3 embedded SERVOPACK SGD7S-####B000F64	31
Software Tools for Sigma-7C	31
MP3200 Motion Control I/O Option Card	31
MP Control Communication Modules for MP3200	31
SERVOPACK accessories SGD7C-####20	31
MECHATROLINK 3 Cables and Connectors	32
<b>Servopack Sigma 7 - Analog / Pulse Type 200V</b>	
Analog/Pulse SERVOPACK SGD7S-####00	33
Analog/Pulse SERVOPACK Accessories SGD7S-####00	33
Filters for SGD7S Servopacks (Combi Filters including control power)	33
Reactors for SGD7S Servopacks	33
<b>Servopack Sigma 7 - Mechatrolink II Type 200V</b>	
Mechatrolink II SERVOPACK SGD7S-####10	34
Mechatrolink II SERVOPACK accessories SGD7S-####10	34
Filters for SGD7S Servopacks (Combi Filters including control power)	35
Reactors for SGD7S Servopacks	35
<b>Servopack Sigma 7 - Mechatrolink III Type Single Axis 200V</b>	
Mechatrolink III SERVOPACK SGD7S-####20	36
Mechatrolink III SERVOPACK accessories SGD7S-####20	36
Filters for SGD7S Servopacks (Combi Filters including control power)	37
Reactors for SGD7S Servopacks	37
<b>Servopack Sigma 7 - Mechatrolink III Type Double Axis 200V</b>	
Mechatrolink III Double Axis SERVOPACK SGD7W-####20	37
Mechatrolink III SERVOPACK accessories SGD7W-####20	38
Reactors for SGD7W Servopacks	38
<b>Servopack Sigma 7 - EtherCAT embedded Type 200V</b>	
EtherCAT embedded SERVOPACK SGD7S-####A0	39
EtherCAT embedded SERVOPACK accessories SGD7S-####A0	39
Filters for SGD7S Servopacks (Combi Filters including control power)	39
Reactors for SGD7S Servopacks	39

<b>Medium Inertia Servomotor Sigma 7 Series (SGM7J) 200V</b>	
SGM7J Medium Inertia Servo motor with 24-bit Incremental Encoder	40
SGM7J Medium Inertia Servo motor with 24-bit Incremental Encoder + Brake	40
SGM7J Medium Inertia Servo motor with 24-bit Absolut Encoder	40
SGM7J Medium Inertia Servo motor with 24-bit Absolut Encoder + Brake	40
<b>Low Inertia Servomotor Sigma 7 Series (SGM7A) 200V</b>	
SGM7A Low Inertia Servo motor with 24-bit Incremental Encoder	41
SGM7A Low Inertia Servo motor with 24-bit Incremental Encoder+Brake	41
SGM7A Low Inertia Servo motor with 24-bit Absolute Encoder	41
SGM7A Low Inertia Servo motor with 24-bit Absolute Encoder+Brake	41
Servo Motor Power Cable flexible type 0.05 to 1.50kW SGM7A/7J	42
Servo Motor Power + Brake Cable flexible type 0.05 to 1.00kW SGM7A/7J	42
Servo Motor Brake Cable Flexible for SGM7A 1.5kW Type	42
Servo Motor Connector Kit for SGM7A and SGM7J	42
Incremental Encoder Cable flexible type SGM7A/7J	43
Incremental Encoder Cable flexible type SGM7A/7J, Installed in load direction	43
Incremental Encoder Cable flexible type SGM7A/7J, Installed away from load direction	43
Special Cable for Absolut Encoder	43
Absolute Encoder Cable flexible type SGM7A/7J	43
Absolute Encoder Cable flexible type SGM7A/7J, Installed in load direction	43
Absolute Encoder Cable flexible type SGM7A/7J, Installed in direction away from Load	44
Encoder Connector Kit for SGM7A and SGM7J	44

<b>Medium Inertia Servomotor Sigma 7 Series (SGM7G) 200V</b>	
SGM7G Medium Inertia Servo motor with 24-bit Incremental Encoder	45
SGM7G Medium Inertia Servo motor with 24-bit Incremental Encoder + Brake	45
SGM7G Medium Inertia Servo motor with 24-bit Absolut Encoder	45
SGM7G Medium Inertia Servo motor with 24-bit Absolut Encoder + Brake	45
Servo Motor Power Cable flexible type 0.30 to 1.30kW SGM7G	46
Servo Motor Brake Cable Flexible for SGM7G 0.85-1.30kW Type	46
Incremental Encoder Cable flexible type SGM7G	46
Special Cable for Absolut Encoder	46
Absolute Encoder Cable flexible type SGM7G	46
SGM7G 200V Connectors	46
<b>Servopack Sigma 7 - EtherCAT embedded Type 400V</b>	
EtherCAT embedded SERVOPACK SGD7S-####B000F64	47
EtherCAT embedded SERVOPACK with holding brake relay SGD7S-####B026F64	47
EtherCAT embedded DUAL AXIS SERVOPACK SGD7W-###DA0B	47
EtherCAT embedded DUAL AXIS SERVOPACK with holding brake relay SGD7W-###DA0B026	47
EtherCAT embedded SERVOPACK accessories SGD7S-###DA0	47
Filters for SGD7S Servopacks (Filters for main power only!)	48
DC Reactors for SGD7S Servopacks	48
<b>Servopack Sigma 7 - Mechatrolink 3 embedded 400V</b>	
Mechatrolink 3 embedded SERVOPACK SGD7S-####B000F64	49
Mechatrolink 3 embedded SERVOPACK with holding brake relay SGD7S-####B026F64	49
Mechatrolink 3 embedded DUAL AXIS SERVOPACK SGD7W-###D30B	49
Mechatrolink 3 embedded DUAL AXIS SERVOPACK with holding brake relay SGD7W-###D30B026	49
Mechatrolink 3 embedded SERVOPACK accessories SGD7S-###D30	49
Filters for SGD7S Servopacks (Filters for main power only!)	50
DC Reactors for SGD7S Servopacks	50
<b>Medium Inertia, High Speed Servomotor Sigma 7 Series (SGM7J) 400V</b>	
SGM7J Medium Inertia Servo motor with 24-bit Incremental Encoder	51
SGM7J Medium Inertia Servo motor with 24-bit Incremental Encoder + Brake	51
SGM7J Medium Inertia Servo motor with 24-bit Absolut Encoder	51
SGM7J Medium Inertia Servo motor with 24-bit Absolut Encoder + Brake	51
Servo Motor Power Cable flexible type 0.20 to 1.50kW SGM7J	52
Servo Motor Power Cable flexible type for Motors with Brake 0.20 to 1.50kW SGM7J	52
Incremental Encoder Cable flexible type with straight Connector SGM7J	52
Incremental Encoder Cable flexible type with angled Connector SGM7J	52
Special Cable for Extension for Absolut Encoder	52
<b>Low Inertia, High Speed Servomotor Sigma 7 Series (SGM7A) 400V</b>	
SGM7A Low Inertia Servo motor with 24-bit Incremental Encoder	53
SGM7A Low Inertia Servo motor with 24-bit Incremental Encoder+Brake	53
SGM7A Low Inertia Servo motor with 24-bit Absolute Encoder	54
SGM7A Low Inertia Servo motor with 24-bit Absolute Encoder+Brake	54
Servo Motor Power Cable flexible type 0.20 to 3.00kW SGM7A	54
Servo Motor Power Cable flexible type for Motors with Brake 0.20 to 3.00kW SGM7A	55
Incremental Encoder Cable flexible type with straight Connector SGM7A	56
Incremental Encoder Cable flexible type with angled Connector SGM7A	56
Special Cable for Extension for Absolut Encoder	56
<b>Medium Inertia, Low Speed, High Torque Servomotor Sigma 7 Series (SGM7G)</b>	
SGM7G Medium Inertia Servo motor with 24-bit Incremental Encoder	57
SGM7G Medium Inertia Servo motor with 24-bit Incremental Encoder + Brake	57
SGM7G Medium Inertia Servo motor with 24-bit Absolut Encoder	58
SGM7G Medium Inertia Servo motor with 24-bit Absolut Encoder + Brake	58
Servo Motor Power Cable flexible type SGM7G	58
Servo Motor Power Cable flexible type for Motors with Brake SGM7G	59
Incremental Encoder Cable flexible type with straight Connector SGM7G	60
Incremental Encoder Cable flexible type with angled Connector SGM7G	60
Special Cable for Extension for Absolut Encoder	60
<b>Medium Inertia, High Speed, High Torque Servomotor Sigma 7 Series (SGM7G)</b>	
SGM7G Medium Inertia High Speed Servo motor with 24-bit Incremental Encoder	61
SGM7G Medium Inertia High Speed Servo motor with 24-bit Incremental Encoder + Brake	61
SGM7G Medium Inertia High Speed Servo motor with 24-bit Absolute Encoder	61
SGM7G Medium Inertia High Speed Servo motor with 24-bit Absolute Encoder+ brake	62
Servo Motor Power Cable flexible type SGM7G	62
Servo Motor Power Cable flexible type for Motors with Brake SGM7G	63
Incremental Encoder Cable flexible type with straight Connector SGM7G	63
Incremental Encoder Cable flexible type with angled Connector SGM7G	63
Special Cable for Extension for Absolut Encoder	63

<b>Servopack Sigma V - Analog / Pulse Type</b>	
Analog/Pulse SERVOPACK rotary SGDV-####01	64
Analog/Pulse SERVOPACK linear SGDV-####05	64
Analog/Pulse SERVOPACK Accessories SGDV-####01/05	65
Filters for SGDV Servopacks	65
Filters for SGDV Servopacks (Combi Filters including control power)	65
Reactors for SGDV Servopacks	65
<b>Servopack Sigma V MINI for 24VDC / 48VDC Motors - Analog Voltage Reference - Pulse Train Reference</b>	
Analog Voltage Reference SERVOPACK rotary SGDV-####S1 for 24VDC / 48VDC Motors	66
Pulse Train Reference SERVOPACK rotary SGDV-####P1 for 24VDC / 48VDC Motors	66
Accessories for SGDV-####S1/P1 - Analog Voltage Reference + Pulse Train Reference SERVOPACK	66
<b>Servopack Sigma V - Analog / Pulse Type for Large Capacity Motors</b>	
Analog/Pulse Large Capacity SERVOPACK SGDV-####01	67
Converter for Analog/Pulse Large Capacity SERVOPACK SGDV-####01	67
Analog/Pulse Large Capacity SERVOPACK Accessories SGDV-####01	67
<b>Servopack Sigma V - Mechatrolink II Type</b>	
Mechatrolink II SERVOPACK Rotary SGDV-####11	68
Mechatrolink II SERVOPACK Linear SGDV-####15	68
Mechatrolink II SERVOPACK accessories SGDV-####11/15	68
Filters for SGDV Servopacks	69
Filters for SGDV Servopacks (Combi Filters including control power)	69
Reactors for SGDV Servopacks	69
<b>Servopack Sigma V MINI for 24VDC / 48VDC Motors - Mechatrolink II Type</b>	
Mechatrolink II SERVOPACK rotary SGDV-####11 for 24VDC / 48VDC Motors	70
Accessories for SGDV-####11 - Mechatrolink II SERVOPACK	70
<b>Servopack Sigma V - Mechatrolink II Type for Large Capacity Motors</b>	
Mechatrolink II Large Capacity SERVOPACK SGDV-####11	71
Converter for Mechatrolink II Large Capacity SERVOPACK SGDV-####11	71
Mechatrolink II Large Capacity SERVOPACK Accessories SGDV-####11	71
<b>Servopack Sigma V - Mechatrolink III Type</b>	
Mechatrolink III SERVOPACK Rotary SGDV-####21	72
Mechatrolink III SERVOPACK Linear SGDV-####25	72
Mechatrolink III SERVOPACK accessories SGDV-####21/25	73
Filters for SGDV Servopacks	73
Filters for SGDV Servopacks (Combi Filters including control power)	73
Reactors for SGDV Servopacks	74
<b>Servopack Sigma V MINI for 24VDC / 48VDC Motors - Mechatrolink III Type</b>	
Mechatrolink III SERVOPACK rotary SGDV-####21 for 24VDC / 48VDC Motors	74
Accessories for SGDV-####S21 - Mechatrolink III SERVOPACK	74
<b>Servopack Sigma V - Mechatrolink III Type for Large Capacity Motors</b>	
Mechatrolink III Large Capacity SERVOPACK SGDV-####21	75
Converter for Mechatrolink III Large Capacity SERVOPACK SGDV-####21	75
Mechatrolink III Large Capacity SERVOPACK Accessories SGDV-####21	75
<b>Servopack Sigma V - Other Network Type</b>	
Other Network SERVOPACK Rotary SGDV-####E1	76
Other Network SERVOPACK Linear SGDV-####E5	76
Other Network SERVOPACK accessories SGDV-####E1/E5 and Options	77
Filters for SGDV Servopacks	77
Filters for SGDV Servopacks (Combi Filters including control power)	77
Reactors for SGDV Servopacks	78
<b>Servopack Sigma V - Other Network Type for Large Capacity Motors</b>	
Other Network Type Large Capacity SERVOPACK SGDV-####E1	78
Converter for Other Network Type Large Capacity SERVOPACK SGDV-####E1	78
Other Network Type Large Capacity SERVOPACK Accessories SGDV-####E1	78

<b>Low Inertia &amp; Ultra Small Capacity Servomotor Sigma V Series (SGMMV)</b>	
SGMMV Low Inertia & Ultra Small Capacity Servomotor with 17-bit Absolut Encoder 200V for SGDV-R90A & -1R6A	79
SGMMV Low Inertia & Ultra Small Capacity Servomotor with 17-bit Absolut Encoder 200V + Brake for SGDV-R90A & -1R6A	79
Servo Motor Power Cable Standard Type for SGMMV 200V	79
Servo Motor Power Cable Flexible Type for SGMMV 200V	79
Servo Motor Power Cable Standard Type + Brake for SGMMV 200V	79
Servo Motor Power Cable Flexible Type + Brake for SGMMV 200V	79
SGMMV Low Inertia & Ultra Small Capacity Servomotor with 17-bit Absolut Encoder 24VDC / 48VDC for SGDV-1R7E & -2R9E	80
SGMMV Low Inertia & Ultra Small Capacity Servomotor with 17-bit Absolut Encoder 24VDC / 48VDC + Brake for SGDV-1R7E & -2R9E	80
Servo Motor Power Cable Standard Type for SGMMV 24VDC / 48VDC	80
Servo Motor Power Cable Flexible Type for SGMMV 24VDC / 48VDC	80
Servo Motor Power Cable Standard Type + Brake for SGMMV 24VDC / 48VDC	80
Servo Motor Power Cable Flexible Type + Brake for SGMMV 24VDC / 48VDC	81
Absolute Encoder Cable Standard Type for SGMMV 200V + 24VDC / 48VDC	81
Absolute Encoder Cable Flexible Type for SGMMV 200V + 24VDC / 48VDC	81
Encoder Connector Kit for SGMMV 200V + 24VDC / 48VDC	81
<b>Low Inertia Servomotor Sigma V Series (SGMAV)</b>	
SGMAV Low Inertia Servo motor with 20-bit incremental Encoder	82
SGMAV Low Inertia Servo motor with 20-bit incremental Encoder + Brake	82
SGMAV Low Inertia Servo motor with 20-bit Absolute Encoder	82
SGMAV Low Inertia Servo motor with 20-bit Absolute Encoder + Brake	82
<b>Medium Inertia Servomotor Sigma V Series (SGMJV)</b>	
SGMJV Medium Inertia Servo motor with 13-bit incremental Encoder	83
SGMJV Medium Inertia Servo motor with 20-bit incremental Encoder	83
SGMJV Medium Inertia Servo motor with 13-bit incremental Encoder + Brake	83
SGMJV Medium Inertia Servo motor with 20-bit incremental Encoder + Brake	83
SGMJV Medium Inertia Servo motor with 20-bit Absolute Encoder	84
SGMJV Medium Inertia Servo motor with 20-bit Absolute Encoder + Brake	84
Servo Motor Power Cable flexible type 0.05 to 1.00kW SGMAV/JV	84
Servo Motor Power + Brake Cable flexible type 0.05 to 1.00kW SGMAV/JV	84
Servo Motor Connector Kit for SGMAV and SGMJV	85
Incremental Encoder Cable flexible type SGMAV/JV	85
Special Cable for Absolut Encoder	85
Absolute Encoder Cable flexible type SGMAV/JV	85
Encoder Connector Kit for SGMAV and SGMJV	85
Safety Cable for Sigma V	85
<b>Low and Medium Inertia Servomotor Sigma V Series (SGMEV)</b>	
SGMEV Servo Motor 400V 3ph 20-bit Incremental Encoder	86
SGMEV Servo Motor 400V 3ph 20-bit Incremental Encoder + Brake	86
SGMEV Servo Motor 400V 3ph 20-bit Absolut Encoder	86
SGMEV Servo Motor 400V 3ph 20-bit Absolut Encoder + Brake	86
SGMEV Servo Motor Power Cable Flexible 400V	87
SGMEV Servo Motor Power + Brake Cable Flexible 400V	87
SGMEV Encoder Cable Flexible 400V	87
Special Cable for Absolut Encoder 400V	87
SGMEV Connectors 400 V	87
SGMEV Servo Motor 200V 3ph 20-bit Incremental Encoder	87
SGMEV Servo Motor 200V 3ph 20-bit Incremental Encoder + Brake	87
SGMEV Servo Motor 200V 3ph 20-bit Absolut Encoder	88
SGMEV Servo Motor 200V 3ph 20-bit Absolut Encoder + Brake	88
SGMEV Servo Motor Power Cable Flexible 200V	88
SGMEV Servo Motor Power + Brake Cable Flexible 200V	88
SGMEV Encoder Cable Flexible 200V	88
Special Cable for Absolut Encoder 200V	88
SGMEV Connectors 200V	88
<b>High Speed Servomotor Sigma V Series (SGMSV)</b>	
SGMSV Low Inertia Servo Motor 20-bit Incremental Encoder	89
SGMSV Low Inertia Servo Motor 20-bit Incremental Encoder + Brake	89
SGMSV Low Inertia Servo Motor 20-bit Absolut Encoder	89
SGMSV Low Inertia Servo Motor 20-bit Absolut Encoder + Brake	89
SGMSV Servo Motor Angled Power Cable Flexible	90
SGMSV Incremental Encoder Angled Cable Flexible	90
SGMSV Absolute Encoder Angled Cable Flexible	90
Special Cable for Absolut Encoder	90
SGMSV Brake Cable Flexible	90
SGMSV Connectors	90

**High Speed Servomotor Sigma V Series (SGMGV)**

SGMGV Servo Motor 20-bit Incremental Encoder	91
SGMGV Servo Motor 20-bit Incremental Encoder + Brake	91
SGMGV Servo Motor 20-bit Absolute Encoder	91
SGMGV Servo Motor 20-bit Absolute Encoder + Brake	91
SGMGV Servo Motor Angled Power Cable Flexible	92
SGMGV Incremental Encoder Angled Cable Flexible	92
Special Cable for Absolut Encoder	93
SGMGV Absolute Encoder Angled Cable Flexible	93
SGMGV Brake Cable Flexible	93
SGMGV Connectors	93

**Planetary Gears ECO and PURE**

Standard Flange Planetary Gear boxes ECO series	94
Standard Flange Low Backlash Planetary Gear boxes PURE series	95
B Flange Planetary Gear boxes ECO series	95
C Flange Planetary Gear boxes ECO series	95
Standard Flange Angled Planetary Gear boxes ECO series	95
B Flange Angled Planetary Gear boxes ECO series	96
C Flange Angled Planetary Gear boxes ECO series	96
Surcharges	96

**Large-Capacity Servomotor Sigma V Series (SGMVV)**

SGMVV Large Capacity Servo Motor 400V, 1.500 rpm - Flange-mounted Type	97
SGMVV Large Capacity Servo Motor 400V, 800 rpm - Flange-mounted Type	97
SGMVV Large Capacity Servo Motor 400V, 1.500 rpm - Foot-mounted Type	97
SGMVV Large Capacity Servo Motor 400V, 800 rpm - Foot-mounted Type	97
SGMVV Large Capacity Servo Motor 400V, 1.500 rpm - Flange-mounted Type + Brake	98
SGMVV Large Capacity Servo Motor 400V, 800 rpm - Flange-mounted Type + Brake	98
SGMVV Large Capacity Servo Motor 400V, 1.500 rpm - Foot-mounted Type + Brake	98
SGMVV Large Capacity Servo Motor 400V, 800 rpm - Foot-mounted Type + Brake	98
SGMVV Large Capacity Servo Motor Power Cable	98
SGMVV Large Capacity Servo Motor Fan Cable	99
SGMVV Incremental Encoder Angled Cable Flexible	99
Special Cable for Absolut Encoder	99
SGMVV Absolute Encoder Angled Cable Standard	99
Dynamic Brake Unit for SGMVV	99
Encoder Connector Kit for SGMVV	99

**Linear Slider****Linear Motors**

Linear Motor SGLGW-Type Coreless Type 200V	100
Magnet Track for Linear Motor SGLGW-Type	100
Linear Motor SGLFW-Type Iron-core-Type 200V	101
Linear Motor SGLFW-Type Iron-core-Type 400V	101
Magnet Track for Linear Motor SGLFW-Type	101
Linear Motor SGLFW2-Type Iron-core-Type 200V without Hall Sensor	102
Linear Motor SGLFW2-Type Iron-core-Type 200V with Hall Sensor	102
Linear Motor SGLFW2-Type Iron-core-Type 400V without Hall Sensor	102
Linear Motor SGLFW2-Type Iron-core-Type 400V with Hall Sensor	102
Magnet Track for Linear Motor SGLFW2-Type	103
Linear Motor SGLTW-Type Iron-core-Type 200V	103
Linear Motor SGLTW-Type Iron-core-Type 400V	103
Magnet Track for Linear Motor SGLTW-Type	104
Serial Converter for Linear Motors in combination with Sigma 5 amplifiers	104
Serial Converter for Linear Motors in combination with Sigma 7 amplifiers	104
Serial Converter Cable to Servopack	105
Linear Servomotor Main Circuit Cables	105
Linear Scale Cable to Serial Converter	105
Hall Sensor Cable to Serial Converter	105
Serial Converter Cable to Motor incl. Thermal protector & Hall Sensor	106
Serial Converter Cable to Motor incl. Thermal protector w/o Hall Sensor	106



**GA700 Inverter**

Inverter GA700 400 VAC Three Phase - IP20	107
Sinus Output-Filter IP00 for GA700 400VAC	107
IP20 Box for Sinus Output-Filter	108
AC Input Reactors 4 % IP00 for GA700 400VAC	108
IP20 Box for AC Input Reactors 4 %	108
AC Input Reactors IP00 2 % for GA700 400VAC	108
IP20 Box for AC Input Reactors 2 %	108
Harmonic Filters (THD-I < 5%) IP00 for GA700 400VAC	109
AC Output Reactors IP00 for GA700 400VAC (up to 120 Hz Output Frequency)	109
IP20 Box for AC Output Reactors IP00 (up to 120 Hz Output Frequency)	109
AC Output Reactors IP00 for GA700 400VAC (up to 50 Hz Output Frequency)	109
IP20 Box for AC Output Reactors IP00 (up to 50 Hz Output Frequency)	110
Inverter GA700 200 VAC Three Phase - IP20	110
Options for GA700 Series	110

**J1000 Inverter**

Inverter J1000 400 VAC Three Phase - IP20	111
Inverter J1000 400 VAC Three Phase - Cold Plate	111
EMC Line-Filters for J1000 400VAC	111
Inverter J1000 200 VAC Single Phase - IP20	111
Inverter J1000 200 VAC Single Phase IP20 - Cold Plate	111
EMC Line-Filters for J1000 200VAC Single Phase	111
Inverter J1000 200 VAC Three Phase - IP20	112
Inverter J1000 200 VAC Three Phase IP20 - Cold Plate	112
EMC Line-Filters for J1000 200VAC Three Phase	112
Options for J1000 Series	112

**V1000 Inverter**

Inverter V1000 400 VAC Three Phase - IP20 / NEMA1	113
Inverter V1000 400 VAC Three Phase - Cold Plate	113
Inverter V1000 400 VAC Three Phase - IP66	113
Inverter V1000 400 VAC Three Phase - IP20 / NEMA1 with 1000 Hz Software	114
EMC Line-Filters for V1000 400 VAC	114
Sinus Output-Filter IP00 for V1000 400 VAC	114
IP20 Box for Sinus Output-Filter	114
dV/dt Output-Filter IP00 for V1000 400 VAC	114
IP20 Box for dV/dt Output-Filter	114
AC Input Reactors 4 % IP00 for V1000 400VAC	115
IP20 Box for AC Input Reactors 4 %	115
AC Input Reactors 2 % IP00 for V1000 400VAC	115
IP20 Box for AC Input Reactors 2 %	115
Harmonic Filters for V1000 400VAC (THD-I < 5%)	115
AC Output Reactors IP00 for V1000 400VAC (up to 120 Hz Output Frequency)	115
IP20 Box for AC Output Reactors IP00 (up to 120 Hz Output Frequency)	116
AC Output Reactors IP00 for V1000 400VAC (up to 50 Hz Output Frequency)	116
IP20 Box for AC Output Reactors IP00 (up to 50 Hz Output Frequency)	116
Inverter V1000 200 VAC Single Phase - IP20	116
Inverter V1000 200 VAC Single Phase - Cold Plate	116
Inverter V1000 200 VAC Single Phase - IP66	117
Inverter V1000 200 VAC Single Phase - IP20 with 1000 Hz Software	117
EMC Line-Filters for V1000 200 VAC Single Phase	117
Inverter V1000 200 VAC Three Phase - IP20/NEMA1	117
Inverter V1000 200 VAC Three Phase - Cold Plate	117
EMC Line-Filters for V1000 200 VAC Three Phase	118
Options for V1000 Series	118

**T1000V Inverter**

Inverter T1000V 400 VAC Three Phase - IP20 / NEMA1	119
Inverter T1000V 400 VAC Three Phase - Cold Plate	119
EMC Line-Filters for T1000V 400 VAC	119
Inverter T1000V 200 VAC Single Phase - IP20	119
Inverter T1000V 200 VAC Single Phase - Cold Plate	119
EMC Line-Filters for T1000V 200 VAC Single Phase	120
EMC Line-Filters for T1000V 200 VAC	120
Options for T1000V Series	120

**L1000V Inverter**

Inverter L1000V 400 VAC Three Phase - IP20 / NEMA1	121
EMC Line-Filters for L1000V 400 VAC	121
Line Reactors IP00 for L1000V 400 VAC	121
IP20 Box for Line Reactors	121
Braking Resistor 50% ED	121
Inverter L1000V 200 VAC Three Phase - IP20 / NEMA1	122
EMC Line-Filters for L1000V 200 VAC	122
Options for L1000V Series	122

<b>A1000 Inverter</b>	
Inverter A1000 400 VAC Three Phase - IP00 / NEMA1	123
Inverter A1000 400 VAC Three Phase - IP00 / NEMA1 with Crane Software	123
Inverter A1000 400 VAC Three Phase - IP00 / NEMA1 with 1000Hz Software	124
Inverter A1000 400 VAC Three Phase - IP54 Wall Mount	124
Inverter A1000 400 VAC Three Phase - IP54 Wall Mount with Main Switch	124
Inverter A1000 400 VAC Three Phase - IP54 Ready	124
EMC Line-Filters for A1000 400VAC (UL on request)	124
IT Net-Filters for A1000 400VAC	125
Sinus Output-Filter IP00 for A1000 400VAC	125
IP20 Box for Sinus Output-Filter	125
dV/dt Output-Filter IP00 for A1000 400VAC	125
IP20 Box for dV/dt Output-Filter	126
AC Input Reactors 4 % IP00 for A1000 400VAC	126
IP20 Box for AC Input Reactors 4 %	126
AC Input Reactors IP00 2 % for A1000 400VAC	126
IP20 Box for AC Input Reactors 2 %	126
Harmonic Filters (THD-I < 5%) IP00 for A1000 400VAC	127
AC Output Reactors IP00 for A1000 400VAC (up to 120 Hz Output Frequency)	127
IP20 Box for AC Output Reactors IP00 (up to 120 Hz Output Frequency)	127
AC Output Reactors IP00 for A1000 400VAC (up to 50 Hz Output Frequency)	128
IP20 Box for AC Output Reactors IP00 (up to 50 Hz Output Frequency)	128
Inverter A1000 200 VAC Three Phase - IP00 / NEMA1	128
Inverter A1000 200 VAC Three Phase - IP00 / NEMA1 with 1000 Hz Software	128
EMC Line-Filters for A1000 200VAC (UL on request)	128
Additional available software for A1000	128
Options for A1000 Series	129
<b>A1000 Floor Standing Inverter IP54</b>	
Inverter A1000 400 VAC Three Phase - FS, IP23, EMC Filter	130
Inverter A1000 400 VAC Three Phase - FS, IP23, EMC Filter, Rotary mains switch with door handle	131
Inverter A1000 400 VAC Three Phase - FS, IP23, EMC Filter, Rotary mains switch with door handle, Circuit breaker	131
Inverter A1000 400 VAC Three Phase - FS, IP54, EMC Filter	131
Inverter A1000 400 VAC Three Phase - FS, IP54, EMC Filter, Rotary mains switch with door handle	131
Inverter A1000 400 VAC Three Phase - FS, IP54, EMC Filter, Rotary mains switch with door handle, Circuit breaker	131
<b>T1000A Inverter</b>	
Inverter T1000A 400 VAC Three Phase - IP20	132
Inverter T1000A 400 VAC Three Phase - Cold Plate / Finless / Fanless	132
EMC Line-Filters for T1000A 400VAC (UL on request)	133
Options for T1000A Series	133
<b>L1000A Inverter</b>	
Inverter L1000A 400 VAC Three Phase - IP20, with SiL3 STO	134
Inverter L1000A 400 VAC Three Phase - IP20, with SiL3 STO and A3/D3CP3	134
EMC Line-Filters for L1000A 400VAC (UL on request)	134
Line Reactors IP00 for L1000A 400 VAC	135
IP20 Box for Line Reactors	135
Braking Resistor 50% ED	135
Inverter L1000A 200 VAC Three Phase - IP20	135
Options for L1000A Series	136

**Lift Motor - MSYP Series**

MSYP-160 Roping = 1:1, Speed = 1m/s	137
MSYP-160 Roping = 2:1, Speed = 1m/s	137
MSYP-160 Roping = 1:1, Speed = 1,6m/s	137
MSYP-160 Roping = 2:1, Speed = 1,6m/s	138
MSYP-225 Roping = 1:1, Max Travel = 30m, Speed = 1m/s	138
MSYP-225 Roping = 2:1, Max Travel = 30m, Speed = 1m/s	138
MSYP-225 Roping = 1:1, Max Travel = 75m, Speed = 1,6m/s	139
MSYP-225 Roping = 2:1, Max Travel = 75m, Speed = 1,6m/s	139
MSYP-225 Roping = 1:1, Max Travel = 130m, Speed = 2m/s	139
MSYP-225 Roping = 2:1, Max Travel = 130m, Speed = 2m/s	139
MSYP-225 Roping = 1:1, Max Travel = 130m, Speed = 2,5m/s	140
MSYP-225 Roping = 2:1, Max Travel = 130m, Speed = 2,5m/s	140
Options for MSYP Lift Motors	140

**R1000 Regenerative Braking Package**

R1000 Regenerative Braking Package 400V incl. 1% Reactor in IP00	141
Price-Adder for IP20 cover for 1% reactor in R1000-Kit	141
Power Coordinating Reactor for A1000 in combination with R1000 - AC Input Reactor 4%	141
IP20 Box for AC Input Reactors 4 %	142
EMC Filter for A1000	142
Power Coordinating Reactor for L1000A in combination with R1000 - AC Input Reactor 8% IP00	142
IP20 Box for AC Input Reactor	142
EMC Filter for L1000A	142
Options for R1000 Series	142

<b>D1000 Converter Package</b>	
D1000 Converter Package 400V incl. LCL Filter Module in IP00 - without EMC Filter	143
D1000 Converter Package 400V incl. LCL Filter Module and EMC Filter	143
Price-Adder for IP20 cover for LCL Filter Module in D1000-Kit (available up to 40kW only!)	143
D1000 Converter Package 200V incl. Input Reactor and Harmonic Filter - without EMC Filter	143
Options for D1000 Series	144
<b>U1000 Converter</b>	
Matrix Converter U1000 400 VAC Three Phase - IP00 - with build-in EMC Filter (C2)	145
Matrix Converter U1000 400 VAC Three Phase - IP00 - without EMC filter	145
Matrix Converter U1000 200 VAC Three Phase - IP00 - with build-in EMC Filter (C2)	145
Matrix Converter U1000 200 VAC Three Phase - IP00 - without EMC filter	146
Options for U1000 Series	146
<b>V1000 MMD - Decentral Inverter</b>	
V1000 MMD - Decentral Inverter with built in Keypad	147
V1000 MMD - Decentral Inverter without Keypad	147
Variants of V1000 MMD	147
Options for V1000 MMD	147
SPRiPM iE4 Motor, 1.500 rpm, B3 foot mount	148
SPRiPM iE4 Motor, 3.000 rpm, B3 foot mount	148
SPRiPM iE4 Motor, 1.500 rpm, B5 flange mount	148
SPRiPM iE4 Motor, 3.000 rpm, B5 flange mount	148
Options for V1000 Series	148
<b>SPRiPM Package - V1000</b>	
SPRiPM Package, 1.500 rpm, foot mount B3 motor - with IP20/NEMA1 inverter	149
SPRiPM Package, 3.000 rpm, foot mount B3 motor - with IP20/NEMA1 inverter	149
SPRiPM Package, 1.500 rpm, flange mount B5 motor - with IP20/NEMA1 inverter	149
SPRiPM Package, 3.000 rpm, flange mount B5 motor - with IP20/NEMA1 inverter	149
SPRiPM Package, 1.500 rpm, foot mount B3 motor - with IP66 inverter	150
SPRiPM Package, 3.000 rpm, foot mount B3 motor - with IP66 inverter	150
SPRiPM Package, 1.500 rpm, flange mount B5 motor - with IP66 inverter	150
SPRiPM Package, 3.000 rpm, flange mount B5 motor - with IP66 inverter	150
Options for V1000 Series	151
<b>SPRiPM Package - A1000</b>	
SPRiPM Package, 1.500 rpm, foot mount B3 motor - with IP20/NEMA1 inverter	152
SPRiPM Package, 3.000 rpm, foot mount B3 motor - with IP00/NEMA1 inverter	152
SPRiPM Package, 1.500 rpm, flange mount B5 motor - with IP00/NEMA1 inverter	152
SPRiPM Package, 3.000 rpm, flange mount B5 motor - with IP00/NEMA1 inverter	152
SPRiPM Package, 1.500 rpm, foot mount B3 motor - with IP54 inverter	153
SPRiPM Package, 3.000 rpm, foot mount B3 motor - with IP54 inverter	153
SPRiPM Package, 1.500 rpm, flange mount B5 motor - with IP54 inverter	153
SPRiPM Package, 3.000 rpm, flange mount B5 motor - with IP54 inverter	153
Options for A1000 Series	154
<b>EtherCAT Starter Kit Yaskawa &amp; VIPA</b>	155
<b>Resistors</b>	
Resistors 40 % ED	156
Resistors 40 % ED with Thermosensor & UL	156
Resistors 10 % ED	156
Resistors 10 % ED with Thermosensor & UL	156
Resistors 3 % ED	157
<b>Classification Sheet - Braking Resistors</b>	158
<b>MV 1000</b>	160
<b>Trainings</b>	161

One Yaskawa Software Platform!



## MP2600IEC Machine Controller

- @ Modular machine controller for 1,5 axis, fully integrated into Yaskawa's latest Sigma-5 series servo amplifier
- @ Standard programming languages IEC61131-3
- @ Control functions: position control, gearing, speed control, torque control
- @ PLCopen function blocks
- @ I/O: DI: 8 points, DO: 8 points, AI: 1 channel, AO: 1 channel, 1 Enc. Input, extendable by distributed I/O
- @ Webserver / OPC-server
- @ Communication: Mechatrolink II, EtherNet (100 Mbps): EtherNet IP, Modbus TCP



**MP2600IEC Modular Machine Controller**

Ürün Kodu	Açıklama	Liste Fiyatı
VMK-U-MP26A01R001	MP2600IEC BOX, 1.5 Axis - Machine Controller Module, incl. Mounting Kit and Battery	1.864 EUR

### Software Tools for MP2600IEC - Version 3

Ürün Kodu	Açıklama	Liste Fiyatı
PDE-U-IE3PE	MotionWorks@ IEC Version 3.x Professional, 1 License	1.466 EUR
PDE-U-IE3PH	MotionWorks@ IEC Version 3.x Professional, 1 Floating Licenses	1.715 EUR
PDE-U-IE3SE	MotionWorks@ IEC Version 3.x Express, 1 License	158 EUR
PDE-U-OPCPA	OPC Server WIN XP, 1 License	375 EUR

### Cables and Connectors

Ürün Kodu	Açıklama	Liste Fiyatı
JZSP-BA01	Lithium battery ER3V 50W-05kW cable length 20mm	32 EUR
CBK-U-MP2B-A5	Connector Terminal Converter for I/O Signals, 50-pin, length 0,5m	221 EUR
CBK-U-MP2B-01	Connector Terminal Converter for I/O Signals, 50-pin, length 1,0m	242 EUR
JZSP-CSI02-1-E	CN1 I/O connector with flying lead cable 1m	99 EUR
JZSP-CSI02-2-E	CN1 I/O connector with flying lead cable 2m	121 EUR
JZSP-CSI02-3-E	CN1 I/O connector with flying lead cable 3m	151 EUR
SBK-U-VBA-01	Terminal block for I/O Signals, 26 Pins, length 1 m	229 EUR

One Yaskawa Software Platform !



## MP2300SIEC/ MP2310IEC Machine Controller

- @ All-in-one controller for 4-16 controllable axis
- @ PLCopen function blocks
- @ Standard programming languages IEC61131-3
- @ Control functions: position control, gearing, speed control, torque control, CAM
- @ Open slots for option modules. MP2300SIEC: 1 slot, MP2310IEC: 3 slots
- @ Webserver / OPC-server
- @ I/O: Can be extended by I/O module and distributed I/O
- @ Communication: Mechatrolink II, EtherNet (100 Mbps): EtherNet IP, Modbus TCP
- @ Standards: UL, c-UL, CE

### MP2300SIEC / MP2310IEC Motion Controller

Ürün Kodu	Açıklama	Liste Fiyatı
PMC-U-MP23S16	MP2300SIEC Controller 16Axis, ML-II, Ethernet	2.439 EUR
PMC-U-MP23116	MP2310SIEC Controller 16Axis, ML-II, Ethernet, 3 slot	5.077 EUR

The MP2300SIEC / MP2310IEC Motion Controller does not support Sigma-7.

Please use the MP3300iec version with Sigma-7 MECHATROLINK III amplifier and check with our technical team the application.

### MP2300SIEC / MP2310IEC Motion Control I/O Option Card

Ürün Kodu	Açıklama	Liste Fiyatı
JAPMC-AN2300-E	Analog Input Module AI-01, 8 channels	446 EUR
JAPMC-AN2310-E	Analog Output Module AO-01, 4 channels	484 EUR
JAPMC-DO2300-E	Output Module DO-01, 64 digital Output Point (Sink mode output)	446 EUR
JAPMC-IO2300-E	Input Output Module LIO-01, 16 I/O-Point Sink Mode Output, 1 Pulse Input	339 EUR
JAPMC-IO2301-E	Input Output Module LIO-02, 16 I/O-Point Source Mode Output, 1 Pulse Input	295 EUR
JAPMC-IO2303-E	Input Output Module LIO-04, 32 I/O-Point Sink Mode Output	464 EUR
JAPMC-IO2304-E	Input Output Module LIO-05, 32 I/O-Point Source Mode Output	425 EUR
JAPMC-IO2305-E	Input Output Module LIO-06, 8 I/O Digital (Sink mode output), 1 I/O Analog, 1 Pulse Counter, 1 channel/encoder input	526 EUR
JAPMC-PL2310-E	Pulse Output Module OP-01, 4-Axis Servo Control	1.137 EUR

### Software Tools for MP2300IEC/MP2310IEC - Version 3

Ürün Kodu	Açıklama	Liste Fiyatı
PDE-U-IE3PE	MotionWorks® IEC Version 3.x Professional, 1 License	1.466 EUR
PDE-U-IE3PH	MotionWorks® IEC Version 3.x Professional, 1 Floating Licenses	1.715 EUR
PDE-U-IE3SE	MotionWorks® IEC Version 3.x Express, 1 License	158 EUR
PDE-U-OPCPA	OPC Server WIN XP, 1 License	375 EUR

## Cables and Connectors

Ürün Kodu	Açıklama	Liste Fiyatı
JEPMC-W6002-A5-E	CN6 A/B MECHATROLINK II Communication Cable with connectors at both ends (0,5m)	67 EUR
JEPMC-W6002-01-E	CN6 A/B MECHATROLINK II Communication Cable with connectors at both ends (1m)	70 EUR
JEPMC-W6002-03-E	CN6 A/B MECHATROLINK II Communication Cable with connectors at both ends (2m)	81 EUR
JEPMC-W6002-05-E	CN6 A/B MECHATROLINK II Communication Cable with connectors at both ends (5m)	95 EUR
JEPMC-W6002-10-E	CN6 A/B MECHATROLINK II Communication Cable with connectors at both ends (10m)	113 EUR
JEPMC-W6002-20-E	CN6 A/B MECHATROLINK II Communication Cable with connectors at both ends (20m)	158 EUR
JEPMC-W6002-30-E	CN6 A/B MECHATROLINK II Communication Cable with connectors at both ends (30m)	301 EUR
JEPMC-W6002-40-E	CN6 A/B MECHATROLINK II Communication Cable with connectors at both ends (40m)	327 EUR
JEPMC-W6002-50-E	CN6 A/B MECHATROLINK II Communication Cable with connectors at both ends (50m)	355 EUR
JEPMC-W6003-A5-E-G5	CN6 A/B MECHATROLINK II Communication Cable with ring core (0,5m)	60 EUR
JEPMC-W6003-01-E-G5	CN6 A/B MECHATROLINK II Communication Cable with ring core (1m)	95 EUR
JEPMC-W6003-03-E-G5	CN6 A/B MECHATROLINK II Communication Cable with ring core (3m)	101 EUR
JEPMC-W6003-05-E-G5	CN6 A/B MECHATROLINK II Communication Cable with ring core (5m)	113 EUR
JEPMC-W6003-10-E-G5	CN6 A/B MECHATROLINK II Communication Cable with ring core (10m)	133 EUR
JEPMC-W6003-20-E-G5	CN6 A/B MECHATROLINK II Communication Cable with ring core (20m)	182 EUR
JEPMC-W6021-E	Ring Core for Mechatrolink-II cable	32 EUR
JEPMC-W6022-E	Terminator for Mechatrolink-II	27 EUR
JEPMC-W2061-A5-E	I/O Cable for LIO-01 & -02 with connector (0,5m)	155 EUR
JEPMC-W2061-01-E	I/O Cable for LIO-01 & -02 with connector (1m)	155 EUR
JEPMC-W2061-03-E	I/O Cable for LIO-01 & -02 with connector (3m)	164 EUR
JEPMC-W2064-A5-E	I/O Cable for LIO-06 Module with connector (0,5m)	149 EUR
JEPMC-W2064-01-E	I/O Cable for LIO-06 Module with connector (1m)	151 EUR
JEPMC-W2064-03-E	I/O Cable for LIO-06 Module with connector (3m)	187 EUR
JEPMC-W6060-05-E	I/O Cable for LIO-4 LIO-5 DO-01 with connector (0,5m)	117 EUR
JEPMC-W6060-10-E	I/O Cable for LIO-4 LIO-5 DO-01 with connector (1m)	140 EUR
JEPMC-W6060-30-E	I/O Cable for LIO-4 LIO-5 DO-01 with connector (3m)	172 EUR
JEPMC-W6080-05-E	Input cable with a connector on the AI-01 end (0,5m)	327 EUR
JEPMC-W6080-10-E	Input cable with a connector on the AI-01 end (1m)	365 EUR
JEPMC-W6080-30-E	Input cable with a connector on the AI-01 end (3m)	387 EUR
JEPMC-W6090-05-E	Output Cable AI-01 (0,5m)	133 EUR
JEPMC-W6090-10-E	Output Cable AI-01 (1m)	161 EUR
JEPMC-W6090-30-E	Output Cable AI-01 (3m)	196 EUR

## Distributed I/O Module for Mechatrolink II

Ürün Kodu	Açıklama	Liste Fiyatı
JEPMC-IO2310-E	24 VDC; 64-point input/output, sink mode output	964 EUR
JEPMC-IO2330-E	24 VDC; 64-point input/output, source mode output	964 EUR

## I/O Cable

Ürün Kodu	Açıklama	Liste Fiyatı
JEPMC-W5410-05-E	I/O Cable for IO2310 & IO2330 with connector (5m)	179 EUR
JEPMC-W5410-10-E	I/O Cable for IO2310 & IO2330 with connector (10m)	196 EUR
JEPMC-W5410-30-E	I/O Cable for IO2310 & IO2330 with connector (30m)	238 EUR

## Options

Ürün Kodu	Açıklama	Liste Fiyatı
JZSP-BA01	Lithium battery ER3V 50W-05kW cable length 20mm	32 EUR
JEPMC-OP2300	Blank cover for base units MP2000/3000 Series	14 EUR
JEPMC-OP300	DIN rail attachment	27 EUR
JEPMC-OP2300S-E	Unit Base Attachment for installing the machine controller	32 EUR





## MP3200IEC Machine Controller

- @ High Performance Automation Controller for 16-62 controllable real axis + virtual axis + encoder axis
- @ Advanced control functions: Position control, gearing, speed control, torque control, CAM
- @ Accel/decel processing: Linear, Exponential, Moving average
- @ IEC61131-3 programming environment for Motion & Logic
- @ PLCopen function blocks
- @ 1 GHz, 64-bit processor
- @ 8 open slots for the optional modules using attachable rack
- @ Webserver and OPC-server
- @ Communication: Mechatrolink III, EtherNet (100 Mbps)
- @ Controller-Centric Commissioning using
- @ Standards: UL, c-UL, CE

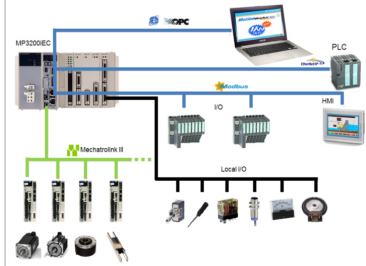

### MP3200IEC High Performance Automation Controller

Ürün Kodu	Açıklama	Liste Fiyatı
PMC-U-MP32016	Motion Controller MP3200IEC, CPU, 16 axis	6.708 EUR
PMC-U-MP32032	Motion Controller MP3200IEC, CPU, 32 axis	7.379 EUR
PMC-U-MP32062	Motion Controller MP3200IEC, CPU, 62 axis	8.049 EUR

### Power Supply Units for MP3200IEC

Ürün Kodu	Açıklama	Liste Fiyatı
JEPMC-PSA3012-E	Power Supply 100V/200V for MP3200	1.409 EUR
JEPMC-PSD3012-E	Power Supply 24VDC for MP3200	1.409 EUR

### Base Units for MP3200IEC

Ürün Kodu	Açıklama	Liste Fiyatı
JEPMC-BUB3003-E	Base Unit, 3 Slots for MP3200	525 EUR
JEPMC-BUB3005-E	Base Unit, 5 Slots for MP3200	659 EUR
JEPMC-BUB3008-E	Base Unit, 8 Slots for MP3200	704 EUR

### MP3200IEC Motion Control I/O Option Card

Ürün Kodu	Açıklama	Liste Fiyatı
JAPMC-AN2300-E	Analog Input Module AI-01, 8 channels	446 EUR
JAPMC-AN2310-E	Analog Output Module AO-01, 4 channels	484 EUR
JAPMC-DO2300-E	Output Module DO-01, 64 digital Output Point (Sink mode output)	446 EUR
JAPMC-IO2300-E	Input Output Module LIO-01, 16 I/O-Point Sink Mode Output, 1 Pulse Input	339 EUR
JAPMC-IO2301-E	Input Output Module LIO-02, 16 I/O-Point Source Mode Output, 1 Pulse Input	295 EUR
JAPMC-IO2303-E	Input Output Module LIO-04, 32 I/O-Point Sink Mode Output	464 EUR
JAPMC-IO2304-E	Input Output Module LIO-05, 32 I/O-Point Source Mode Output	425 EUR
JAPMC-IO2305-E	Input Output Module LIO-06, 8 I/O Digital (Sink mode output), 1 I/O Analog, 1 Pulse Counter, 1 channel/encoder input	526 EUR
JAPMC-CM2301-E	218IF-Y1 Communication Module, 1x Ethernet 100BASE-TX port, 1x 232C port	560 EUR

### Software Tools for MP3200IEC - Version 3

Ürün Kodu	Açıklama	Liste Fiyatı
PDE-U-IE3PE	MotionWorks® IEC Version 3.x Professional, 1 License	1.466 EUR
PDE-U-IE3PH	MotionWorks® IEC Version 3.x Professional, 1 Floating Licenses	1.715 EUR
PDE-U-IE3SE	MotionWorks® IEC Version 3.x Express, 1 License	158 EUR
PDE-U-OPCPA	OPC Server WIN XP, 1 License	375 EUR

### Mechatrolink III Network Components for MP3200IEC

Ürün Kodu	Açıklama	Liste Fiyatı
JEPMC-MT2000-E	Hub, ML III Network, 8 Slave Ports	1.788 EUR
JEPMC-MT2020-E	Adapter, EtherNet to ML III	2.473 EUR
JEPMC-MTD2310-E	I/O Module, ML III Network, 64 in, 64 out	1.848 EUR
JEPMC-MTA2900-E	Analog Module, ML III Network, 8 Input	1.858 EUR
JEPMC-MTA2910-E	Analog Module, ML III Network, 4 Output	1.858 EUR

## Cables and Connectors

Ürün Kodu	Açıklama	Liste Fiyatı
JEPMC-W6012-A2-E	CN6 A/B MECHATROLINK-III communication cable connectors on both ends (0,2m)	53 EUR
JEPMC-W6012-A5-E	CN6 A/B MECHATROLINK-III communication cable connectors on both ends (0,5m)	56 EUR
JEPMC-W6012-01-E	CN6 A/B MECHATROLINK-III communication cable connectors on both ends (1m)	67 EUR
JEPMC-W6012-02-E	CN6 A/B MECHATROLINK-III communication cable connectors on both ends (2m)	87 EUR
JEPMC-W6012-03-E	CN6 A/B MECHATROLINK-III communication cable connectors on both ends (3m)	105 EUR
JEPMC-W6012-05-E	CN6 A/B MECHATROLINK-III communication cable connectors on both ends (5m)	149 EUR
JEPMC-W6012-10-E	CN6 A/B MECHATROLINK-III communication cable connectors on both ends (10m)	232 EUR
JEPMC-W6012-20-E	CN6 A/B MECHATROLINK-III communication cable connectors on both ends (20m)	414 EUR
JEPMC-W6012-30-E	CN6 A/B MECHATROLINK-III communication cable connectors on both ends (30m)	593 EUR
JEPMC-W6012-50-E	CN6 A/B MECHATROLINK-III communication cable connectors on both ends (50m)	955 EUR
JEPMC-W6013-10-E	CN6 A/B MECHATROLINK-III communication cable connectors on both ends and ring core (10m)	283 EUR
JEPMC-W6013-20-E	CN6 A/B MECHATROLINK-III communication cable connectors on both ends and ring core (20m)	456 EUR
JEPMC-W6013-30-E	CN6 A/B MECHATROLINK-III communication cable connectors on both ends and ring core (30m)	627 EUR
JEPMC-W6013-50-E	CN6 A/B MECHATROLINK-III communication cable connectors on both ends and ring core (50m)	978 EUR
JEPMC-W6014-A5-E	CN6 A/B MECHATROLINK-III communication cable with loose wire at one end (0,5m)	38 EUR
JEPMC-W6014-01-E	CN6 A/B MECHATROLINK-III communication cable with loose wire at one end (1m)	45 EUR
JEPMC-W6014-03-E	CN6 A/B MECHATROLINK-III communication cable with loose wire at one end (3m)	87 EUR
JEPMC-W6014-05-E	CN6 A/B MECHATROLINK-III communication cable with loose wire at one end (5m)	125 EUR
JEPMC-W6014-10-E	CN6 A/B MECHATROLINK-III communication cable with loose wire at one end (10m)	214 EUR
JEPMC-W6014-30-E	CN6 A/B MECHATROLINK-III communication cable with loose wire at one end (30m)	580 EUR
JEPMC-W6014-50-E	CN6 A/B MECHATROLINK-III communication cable with loose wire at one end (50m)	931 EUR
JZSP-CM3RRM0-00P2-E	MECHATROLINK-III communication cable with RJ45 connectors on both ends (0,2m)	81 EUR
JZSP-CM3RRM0-00P5-E	MECHATROLINK-III communication cable with RJ45 connectors on both ends (0,5m)	84 EUR
JZSP-CM3RRM0-01-E	MECHATROLINK-III communication cable with RJ45 connectors on both ends (1m)	91 EUR
JZSP-CM3RRM0-03-E	MECHATROLINK-III communication cable with RJ45 connectors on both ends (3m)	112 EUR
JZSP-CM3RRM0-05-E	MECHATROLINK-III communication cable with RJ45 connectors on both ends (5m)	129 EUR
JZSP-CM3RRM0-10-E	MECHATROLINK-III communication cable with RJ45 connectors on both ends (10m)	183 EUR
JZSP-CM3RR00-20-E	MECHATROLINK-III communication cable with RJ45 connectors on both ends (20m)	302 EUR
JZSP-CM3RR00-30-E	MECHATROLINK-III communication cable with RJ45 connectors on both ends (30m)	401 EUR
JZSP-CM3RMM0-00P2-E	MECHATROLINK-III communication cable with RJ45/IMI connectors (0,2m)	81 EUR
JZSP-CM3RMM0-00P5-E	MECHATROLINK-III communication cable with RJ45/IMI connectors (0,5m)	84 EUR
JZSP-CM3RMM0-01-E	MECHATROLINK-III communication cable with RJ45/IMI connectors (1m)	88 EUR
JZSP-CM3RMM0-03-E	MECHATROLINK-III communication cable with RJ45/IMI connectors (3m)	109 EUR
JZSP-CM3RMM0-05-E	MECHATROLINK-III communication cable with RJ45/IMI connectors (5m)	129 EUR
JZSP-CM3RMM0-10-E	MECHATROLINK-III communication cable with RJ45/IMI connectors (10m)	179 EUR
JZSP-CM3RM00-20-E	MECHATROLINK-III communication cable with RJ45/IMI connectors (20m)	288 EUR
JZSP-CM3RM00-30-E	MECHATROLINK-III communication cable with RJ45/IMI connectors (30m)	386 EUR

## Options

Ürün Kodu	Açıklama	Liste Fiyatı
JZSP-BA01	Lithium battery ER3V 50W-05kW cable length 20mm	32 EUR
JEPMC-OP2300	Blank cover for base units MP2000/3000 Series	14 EUR
JEPMC-OP300	DIN rail attachment	27 EUR
JEPMC-OP2300S-E	Unit Base Attachment for installing the machine controller	32 EUR
JEPMC-OP2400-E	Unit Base Attachment for installing the machine controller	53 EUR
JEPMC-OP3301-E	Front cover for unused slot from Base Units	Sorunuz

## MP3300IEC Modular Type Machine Controller



- @ Compact Machine Controller for 04-32 controllable servo axis
- @ PLCopen Part 4 function blocks (Gantry x,y,z including split axes; Linear and Circular Interpolation)
- @ New Cam Editor
- @ IEC61131-3 programming environment for Motion & Logic
- @ VIPA SLIO Ethernet/IP Hardware Configuration
- @ CPU 400 MHz, 64-bit processor
- @ 2 base units incl. power supply available with 1 and 3 slots.
- @ Webserver and OPC-server
- @ Communication: Mechatrolink III, EtherNet (100 Mbps)
- @ Up to 15 MB application program capacity
- @ Transmission cycles: min. 125 µs (4 stations)
- @ Standards: CE

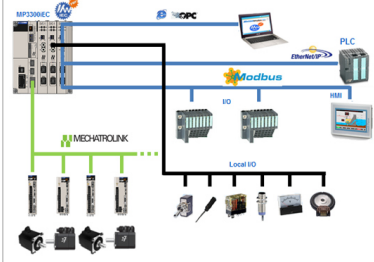

MP3300IEC CPU

Ürün Kodu	Açıklama	Liste Fiyatı
PMC-U-MP33004	Motion Controller, MP3300iec 400MHz, 4MB SRAM CPU 4 axis	2.971 EUR
PMC-U-MP33008	Motion Controller, MP3300iec 400MHz, 4MB SRAM CPU 8 axis	3.268 EUR
PMC-U-MP33020	Motion Controller, MP3300iec 400MHz, 4MB SRAM CPU 20 axis	3.565 EUR
PMC-U-MP33320	Motion Controller, MP3300iec 800MHz, 8MB SRAM CPU 20 axis	3.818 EUR
PMC-U-MP33332	Motion Controller, MP3300iec 800MHz, 8MB SRAM CPU 32 axis	4.019 EUR

### Base Units for MP3300IEC incl. Power Supply

Ürün Kodu	Açıklama	Liste Fiyatı
JEPMC-BU3301-E	MP3300 Base Unit, 8 slot base incl. Power Supply 100/200VAC	1.050 EUR
JEPMC-BU3302-E	MP3300 Base Unit, 8 slot base incl. Power Supply 24V DC	875 EUR
JEPMC-BU3303-E	MP3300 Base Unit, 3 slot base incl. Power Supply 24V DC	692 EUR
JEPMC-BU3304-E	MP3300 Base Unit, 1 slot base incl. Power Supply 24V DC	440 EUR

### MP3300IEC Motion Control I/O Option Card

Ürün Kodu	Açıklama	Liste Fiyatı
JAPMC-AN2300-E	Analog Input Module AI-01, 8 channels	446 EUR
JAPMC-AN2310-E	Analog Output Module AO-01, 4 channels	484 EUR
JAPMC-CM2301-E	218IF-Y1 Communication Module, 1x Ethernet 100BASE-TX port, 1x 232C port	560 EUR
JAPMC-DO2300-E	Output Module DO-01, 64 digital Output Point (Sink mode output)	446 EUR
JAPMC-IO2300-E	Input Output Module LIO-01, 16 I/O-Point Sink Mode Output, 1 Pulse Input	339 EUR
JAPMC-IO2301-E	Input Output Module LIO-02, 16 I/O-Point Source Mode Output, 1 Pulse Input	295 EUR
JAPMC-IO2303-E	Input Output Module LIO-04, 32 I/O-Point Sink Mode Output	464 EUR
JAPMC-IO2304-E	Input Output Module LIO-05, 32 I/O-Point Source Mode Output	425 EUR
JAPMC-IO2305-E	Input Output Module LIO-06, 8 I/O Digital (Sink mode output), 1 I/O Analog, 1 Pulse Counter, 1 channel/encoder input	526 EUR

### Software Tools for MP3300IEC - Version 3

Ürün Kodu	Açıklama	Liste Fiyatı
PDE-U-IE3PE	MotionWorks® IEC Version 3.x Professional, 1 License	1.466 EUR
PDE-U-IE3PH	MotionWorks® IEC Version 3.x Professional, 1 Floating Licenses	1.715 EUR
PDE-U-IE3SE	MotionWorks® IEC Version 3.x Express, 1 License	158 EUR
PDE-U-OPCPA	OPC Server WIN XP, 1 License	375 EUR

### Mechatrolink III Network Components for MP3300IEC

Ürün Kodu	Açıklama	Liste Fiyatı
JEPMC-MT2000-E	Hub, ML III Network, 8 Slave Ports	1.788 EUR
JEPMC-MT2020-E	Adapter, EtherNet to ML III	2.473 EUR
JEPMC-MTD2310-E	I/O Module, ML III Network, 64 in, 64 out	1.848 EUR
JEPMC-MTA2900-E	Analog Module, ML III Network, 8 Input	1.858 EUR
JEPMC-MTA2910-E	Analog Module, ML III Network, 4 Output	1.858 EUR

## Cables and Connectors

Ürün Kodu	Açıklama	Liste Fiyatı
JEPMC-W6012-A2-E	CN6 A/B MECHATROLINK-III communication cable connectors on both ends (0,2m)	53 EUR
JEPMC-W6012-A5-E	CN6 A/B MECHATROLINK-III communication cable connectors on both ends (0,5m)	56 EUR
JEPMC-W6012-01-E	CN6 A/B MECHATROLINK-III communication cable connectors on both ends (1m)	67 EUR
JEPMC-W6012-02-E	CN6 A/B MECHATROLINK-III communication cable connectors on both ends (2m)	87 EUR
JEPMC-W6012-03-E	CN6 A/B MECHATROLINK-III communication cable connectors on both ends (3m)	105 EUR
JEPMC-W6012-05-E	CN6 A/B MECHATROLINK-III communication cable connectors on both ends (5m)	149 EUR
JEPMC-W6012-10-E	CN6 A/B MECHATROLINK-III communication cable connectors on both ends (10m)	232 EUR
JEPMC-W6012-20-E	CN6 A/B MECHATROLINK-III communication cable connectors on both ends (20m)	414 EUR
JEPMC-W6012-30-E	CN6 A/B MECHATROLINK-III communication cable connectors on both ends (30m)	593 EUR
JEPMC-W6012-50-E	CN6 A/B MECHATROLINK-III communication cable connectors on both ends (50m)	955 EUR
JEPMC-W6013-10-E	CN6 A/B MECHATROLINK-III communication cable connectors on both ends and ring core (10m)	283 EUR
JEPMC-W6013-20-E	CN6 A/B MECHATROLINK-III communication cable connectors on both ends and ring core (20m)	456 EUR
JEPMC-W6013-30-E	CN6 A/B MECHATROLINK-III communication cable connectors on both ends and ring core (30m)	627 EUR
JEPMC-W6013-50-E	CN6 A/B MECHATROLINK-III communication cable connectors on both ends and ring core (50m)	978 EUR
JEPMC-W6014-A5-E	CN6 A/B MECHATROLINK-III communication cable with loose wire at one end (0,5m)	38 EUR
JEPMC-W6014-01-E	CN6 A/B MECHATROLINK-III communication cable with loose wire at one end (1m)	45 EUR
JEPMC-W6014-03-E	CN6 A/B MECHATROLINK-III communication cable with loose wire at one end (3m)	87 EUR
JEPMC-W6014-05-E	CN6 A/B MECHATROLINK-III communication cable with loose wire at one end (5m)	125 EUR
JEPMC-W6014-10-E	CN6 A/B MECHATROLINK-III communication cable with loose wire at one end (10m)	214 EUR
JEPMC-W6014-30-E	CN6 A/B MECHATROLINK-III communication cable with loose wire at one end (30m)	580 EUR
JEPMC-W6014-50-E	CN6 A/B MECHATROLINK-III communication cable with loose wire at one end (50m)	931 EUR
JZSP-CM3RRM0-00P2-E	MECHATROLINK-III communication cable with RJ45 connectors on both ends (0,2m)	81 EUR
JZSP-CM3RRM0-00P5-E	MECHATROLINK-III communication cable with RJ45 connectors on both ends (0,5m)	84 EUR
JZSP-CM3RRM0-01-E	MECHATROLINK-III communication cable with RJ45 connectors on both ends (1m)	91 EUR
JZSP-CM3RRM0-03-E	MECHATROLINK-III communication cable with RJ45 connectors on both ends (3m)	112 EUR
JZSP-CM3RRM0-05-E	MECHATROLINK-III communication cable with RJ45 connectors on both ends (5m)	129 EUR
JZSP-CM3RRM0-10-E	MECHATROLINK-III communication cable with RJ45 connectors on both ends (10m)	183 EUR
JZSP-CM3RR00-20-E	MECHATROLINK-III communication cable with RJ45 connectors on both ends (20m)	302 EUR
JZSP-CM3RR00-30-E	MECHATROLINK-III communication cable with RJ45 connectors on both ends (30m)	401 EUR
JZSP-CM3RMM0-00P2-E	MECHATROLINK-III communication cable with RJ45/IMI connectors (0,2m)	81 EUR
JZSP-CM3RMM0-00P5-E	MECHATROLINK-III communication cable with RJ45/IMI connectors (0,5m)	84 EUR
JZSP-CM3RMM0-01-E	MECHATROLINK-III communication cable with RJ45/IMI connectors (1m)	88 EUR
JZSP-CM3RMM0-03-E	MECHATROLINK-III communication cable with RJ45/IMI connectors (3m)	109 EUR
JZSP-CM3RMM0-05-E	MECHATROLINK-III communication cable with RJ45/IMI connectors (5m)	129 EUR
JZSP-CM3RMM0-10-E	MECHATROLINK-III communication cable with RJ45/IMI connectors (10m)	179 EUR
JZSP-CM3RM00-20-E	MECHATROLINK-III communication cable with RJ45/IMI connectors (20m)	288 EUR
JZSP-CM3RM00-30-E	MECHATROLINK-III communication cable with RJ45/IMI connectors (30m)	386 EUR

## Options

Ürün Kodu	Açıklama	Liste Fiyatı
JZSP-BA01	Lithium battery ER3V 50W-05kW cable length 20mm	32 EUR
JEPMC-OP2300	Blank cover for base units MP2000/3000 Series	14 EUR
JEPMC-OP300	DIN rail attachment	27 EUR
JEPMC-OP2300S-E	Unit Base Attachment for installing the machine controller	32 EUR
JEPMC-OP2400-E	Unit Base Attachment for installing the machine controller	53 EUR
JEPMC-OP3301-E	Front cover for unused slot from Base Units	16 EUR

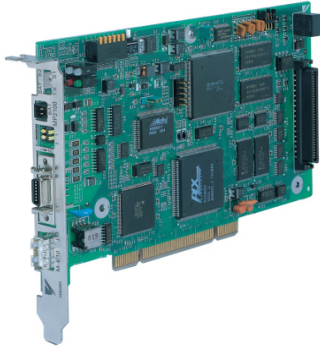

**MP2100 Machine Controller**

## MP Control PC Board for MP2100

Ürün Kodu	Açıklama	Liste Fiyatı
JAPMC-MC2100-E	Machine Controller Main unit MP 2100 PC PCI-Board ML-lix1channel 5in-& 4output	1.288 EUR
JAPMC-MC2140-E	Machine Controller Main unit MP 2100M PC PCI-Board, ML-lix2channel 5in-& 4output	2.617 EUR

## Software Tools for MP2100

Ürün Kodu	Açıklama	Liste Fiyatı
CPMC-MPA700	Software Motion API Application Program Interface	3.815 EUR
CPMC-MPE720	Software Motion Works Engineering Tool Version 5 (for MP900 and 2000 series...old version)	899 EUR
CPMC-MPE780	Software Motion Works Engineering Tool Download Version 7 (licence key, for MP2000/3000)	1.086 EUR
CPMC-MPG700	MP Logger; Monitors the machine-controller data on an Excel sheet	1.122 EUR
CPMC-MPL700C	Software MP Loader	224 EUR
CPMC-MPL710	MPLoadMaker; Creates an auto transfer file with application data	763 EUR
CPMC-MPS700	MPScope	907 EUR

## Cables and Connectors

Ürün Kodu	Açıklama	Liste Fiyatı
JEPMC-W6002-A5-E	CN6 A/B MECHATROLINK II Communication Cable with connectors at both ends (0,5m)	67 EUR
JEPMC-W6002-01-E	CN6 A/B MECHATROLINK II Communication Cable with connectors at both ends (1m)	70 EUR
JEPMC-W6002-03-E	CN6 A/B MECHATROLINK II Communication Cable with connectors at both ends (2m)	81 EUR
JEPMC-W6002-05-E	CN6 A/B MECHATROLINK II Communication Cable with connectors at both ends (5m)	95 EUR
JEPMC-W6002-10-E	CN6 A/B MECHATROLINK II Communication Cable with connectors at both ends (10m)	113 EUR
JEPMC-W6002-20-E	CN6 A/B MECHATROLINK II Communication Cable with connectors at both ends (20m)	158 EUR
JEPMC-W6002-30-E	CN6 A/B MECHATROLINK II Communication Cable with connectors at both ends (30m)	301 EUR
JEPMC-W6002-40-E	CN6 A/B MECHATROLINK II Communication Cable with connectors at both ends (40m)	327 EUR
JEPMC-W6002-50-E	CN6 A/B MECHATROLINK II Communication Cable with connectors at both ends (50m)	355 EUR
JEPMC-W6003-A5-E-G5	CN6 A/B MECHATROLINK II Communication Cable with ring core (0,5m)	60 EUR
JEPMC-W6003-01-E-G5	CN6 A/B MECHATROLINK II Communication Cable with ring core (1m)	95 EUR
JEPMC-W6003-03-E-G5	CN6 A/B MECHATROLINK II Communication Cable with ring core (3m)	101 EUR
JEPMC-W6003-05-E-G5	CN6 A/B MECHATROLINK II Communication Cable with ring core (5m)	113 EUR
JEPMC-W6003-10-E-G5	CN6 A/B MECHATROLINK II Communication Cable with ring core (10m)	133 EUR
JEPMC-W6003-20-E-G5	CN6 A/B MECHATROLINK II Communication Cable with ring core (20m)	182 EUR
JEPMC-W6021-E	Ring Core for Mechatrolink-II cable	32 EUR
JEPMC-W6022-E	Terminator for Mechatrolink-II	27 EUR
JEPMC-W2062-A5-E	I/O Cable for MP2100 & MP2500 with connector (0,5m)	76 EUR
JEPMC-W2062-01-E	I/O Cable for MP2100 & MP2500 with connector (1m)	79 EUR
JEPMC-W2062-03-E	I/O Cable for MP2100 & MP2500 with connector (3m)	95 EUR
JEPMC-W2091-01-E	Battery Extension Cable for MP2100 (1m)	301 EUR
JEPMC-W2091-2A5-E	Battery Extension Cable for MP2100 (2,5m)	430 EUR



## MP2200 Machine Controller

### MP Control Base Units for MP2200

Ürün Kodu	Açıklama	Liste Fiyatı
JEPMC-BU2200-E	MP2200 Base unit spec MBU-01 Input power voltage 85V-276VAC Optional Modules 9Slots	677 EUR
JEPMC-BU2210-E	MP2200 Base unit spec MBU-02 Input power voltage 24VDC Optional Modules 9Slots	627 EUR

### MP Control CPU Module for MP2200

Ürün Kodu	Açıklama	Liste Fiyatı
JAPMC-CP2200-E	CPU-01 CPU Module for MP2200	825 EUR
JAPMC-CP2210-E	CPU-02 CPU Module for MP2200 with compact flash port and one USB port	1.452 EUR

### Connection and Motion Modules for MP2200

Ürün Kodu	Açıklama	Liste Fiyatı
JAPMC-EX2200-E	EXIOIF Connection Module between Racks	456 EUR
JAPMC-MC2300	Motion Control Module SVA-01 Analog Output	1.095 EUR
JAPMC-MC2310-E	Motion Control Module SVB-01 Mechatrolink-II	782 EUR

### MP Control Communication Module for MP2200

Ürün Kodu	Açıklama	Liste Fiyatı
JAPMC-CM2300-E	218IF-01 Communication Module Ethernet / RS-232-C	625 EUR
JAPMC-CM2310-E	217IF-01 Communication Module RS-232C / RS-422	369 EUR
JAPMC-CM2320-E	260IF-01 Communication Module DeviceNet / RS-232-C	498 EUR
JAPMC-CM2330-E	261IF-01 Communication Module PROFIBUS / RS-232-C	551 EUR

### MP2200 Motion Control I/O Option Card

Ürün Kodu	Açıklama	Liste Fiyatı
JAPMC-IO2300-E	Description LIO-01, specification 16 Digital inputs, 16 Digital outputs(sink mode output) 1 pulse input.	339 EUR
JAPMC-IO2301-E	Description LIO-02, specification 16 Digital inputs, 16 Digital outputs(source mode output) pulse input	295 EUR
JAPMC-IO2303-E	Description LIO-04, specification 32 digital inputs, 32 digital outputs (sink mode output)	464 EUR

### Software Tools for MP2200

Ürün Kodu	Açıklama	Liste Fiyatı
CPMC-MPE720	Software Motion Works Engineering Tool Version 5 (for MP900 and 2000 series....old version)	899 EUR
CPMC-MPE780	Software Motion Works Engineering Tool Download Version 7 (licence key, for MP2000/3000)	1.086 EUR
CPMC-MPG700	MP Logger; Monitors the machine-controller data on an Excel sheet	1.122 EUR
CPMC-MPL700C	Software MP Loader	224 EUR
CPMC-MPL710	MPLoadMaker; Creates an auto transfer file with application data	763 EUR
CPMC-MPS700	MPScope	907 EUR

## Cables and Connectors

Ürün Kodu	Açıklama	Liste Fiyatı
JEPMC-W6002-A5-E	CN6 A/B MECHATROLINK II Communication Cable with connectors at both ends (0,5m)	67 EUR
JEPMC-W6002-01-E	CN6 A/B MECHATROLINK II Communication Cable with connectors at both ends (1m)	70 EUR
JEPMC-W6002-03-E	CN6 A/B MECHATROLINK II Communication Cable with connectors at both ends (2m)	81 EUR
JEPMC-W6002-05-E	CN6 A/B MECHATROLINK II Communication Cable with connectors at both ends (5m)	95 EUR
JEPMC-W6002-10-E	CN6 A/B MECHATROLINK II Communication Cable with connectors at both ends (10m)	113 EUR
JEPMC-W6002-20-E	CN6 A/B MECHATROLINK II Communication Cable with connectors at both ends (20m)	158 EUR
JEPMC-W6002-30-E	CN6 A/B MECHATROLINK II Communication Cable with connectors at both ends (30m)	301 EUR
JEPMC-W6002-40-E	CN6 A/B MECHATROLINK II Communication Cable with connectors at both ends (40m)	327 EUR
JEPMC-W6002-50-E	CN6 A/B MECHATROLINK II Communication Cable with connectors at both ends (50m)	355 EUR
JEPMC-W6003-A5-E-G5	CN6 A/B MECHATROLINK II Communication Cable with ring core (0,5m)	60 EUR
JEPMC-W6003-01-E-G5	CN6 A/B MECHATROLINK II Communication Cable with ring core (1m)	95 EUR
JEPMC-W6003-03-E-G5	CN6 A/B MECHATROLINK II Communication Cable with ring core (3m)	101 EUR
JEPMC-W6003-05-E-G5	CN6 A/B MECHATROLINK II Communication Cable with ring core (5m)	113 EUR
JEPMC-W6003-10-E-G5	CN6 A/B MECHATROLINK II Communication Cable with ring core (10m)	133 EUR
JEPMC-W6003-20-E-G5	CN6 A/B MECHATROLINK II Communication Cable with ring core (20m)	182 EUR
JEPMC-W6021-E	Ring Core for Mechatrolink-II cable	32 EUR
JEPMC-W6022-E	Terminator for Mechatrolink-II	27 EUR
JEPMC-W2040-A5-E	Connection Cable for SVA-01 with connectors on both ends (0,5m)	271 EUR
JEPMC-W2040-01-E	Connection Cable for SVA-01 with connectors on both ends (1m)	280 EUR
JEPMC-W2040-03-E	Connection Cable for SVA-01 with connectors on both ends (3m)	300 EUR
JEPMC-W5311-03-E	Com. cable RS-232C 03m with connector	140 EUR
JEPMC-W5311-15-E	Com. cable RS-232C 15m with connector	220 EUR
JEPMC-W2061-A5-E	I/O Cable for LIO-01 & -02 with connector (0,5m)	155 EUR
JEPMC-W2061-01-E	I/O Cable for LIO-01 & -02 with connector (1m)	155 EUR
JEPMC-W2061-03-E	I/O Cable for LIO-01 & -02 with connector (3m)	164 EUR
JEPMC-W6060-05-E	I/O Cable for LIO-4 LIO-5 DO-01 with connector (0,5m)	117 EUR
JEPMC-W6060-10-E	I/O Cable for LIO-4 LIO-5 DO-01 with connector (1m)	140 EUR
JEPMC-W6060-30-E	I/O Cable for LIO-4 LIO-5 DO-01 with connector (3m)	172 EUR
JEPMC-W2091-A5-E	EXIOIF Cable for CNTR-01 Counter Module with connector (0,5m)	315 EUR
JEPMC-W2091-01-E	EXIOIF Cable for CNTR-01 Counter Module with connector (1m)	301 EUR
JEPMC-W2091-2A5-E	EXIOIF Cable for CNTR-01 Counter Module with connector (2,5m)	430 EUR



## MP2300 / MP2310 / MP2300S Machine Controller

### MP Control Basic Module for MP2300/MP2310/MP2300S

Ürün Kodu	Açıklama	Liste Fiyatı
JEPMC-MP2300-E	Machine Controller Main unit MP2300 Basic Modules input power 24VDC ML-Ilx1channel 8in-& 4output	1.663 EUR
JEPMC-MP2300S-E	Machine Controller Main unit MP2300S Basic Modules input power 24VDC ML-Ilx1channel Ethernet	1.898 EUR
JEPMC-MP2310-E	Machine Controller Main unit MP2310 Basic Modules input power 24VDC ML-Ilx1channel Ethernet	2.109 EUR

### Motion Modules for MP2300/MP2310/MP2300S

Ürün Kodu	Açıklama	Liste Fiyatı
JAPMC-MC2300	Motion Control Module SVA-01 Analog Output	1.095 EUR
JAPMC-MC2310-E	Motion Control Module SVB-01 Mechatrolink-II	782 EUR
JAPMC-PL2310-E	Pulse Output Module OP-01 4-Axis Servo Control	1.137 EUR

### MP Control Communication Module for MP2300/MP2310/MP2300S

Ürün Kodu	Açıklama	Liste Fiyatı
JAPMC-CM2300-E	218IF-01 Communication Module Module for Ethernet / RS-232-C	625 EUR
JAPMC-CM2302-E	218IF-02 Communication Module Module for Ethernet / RS-232-C	986 EUR
JAPMC-CM2310-E	217IF-01 Communication Module RS-232C / RS-422	369 EUR
JAPMC-CM2320-E	260IF-01 Communication Module DeviceNet / RS-232-C	498 EUR
JAPMC-CM2330-E	261IF-01 Communication Module PROFIBUS / RS-232-C	551 EUR
JAPMC-CM2360-E	RS-232C/MPLINK communication	1.165 EUR

### MP2300/MP2310/MP2300S Motion Control I/O Option Card

Ürün Kodu	Açıklama	Liste Fiyatı
JAPMC-AN2300-E	Description AI-01, specification Analogue input, 8 channels	446 EUR
JAPMC-AN2310-E	Description AO-01, specification Analogue output, 4 channels	484 EUR
JAPMC-DO2300-E	Description DO-01, specification 64 outputs (Sink mode output)	446 EUR
JAPMC-IO2300-E	Description LIO-01, specification 16 Digital inputs, 16 Digital outputs(sink mode output) 1 pulse input	339 EUR
JAPMC-IO2301-E	Description LIO-02, specification 16 Digital inputs, 16 Digital outputs(source mode output) input	295 EUR
JAPMC-IO2303-E	Description LIO-04, specification 32 digital inputs, 32 digital outputs (sink mode output)	464 EUR
JAPMC-IO2304-E	Description LIO-05, specification 32 digital inputs, 32 digital outputs (source mode output)	425 EUR
JAPMC-PL2300-E	Description CNTR-01, specification 2 channel function, reversible counter, interval counter, frequency measurement	786 EUR

### Software Tools for MP2300/2300S/2310

Ürün Kodu	Açıklama	Liste Fiyatı
CPMC-MPE720	Software Motion Works Engineering Tool Version 5 (for MP900 and 2000 series....old version)	899 EUR
CPMC-MPE780	Software Motion Works Engineering Tool Download Version 7 (licence key, for MP2000/3000)	1.086 EUR
CPMC-MPG700	MP Logger; Monitors the machine-controller data on an Excel sheet	1.122 EUR
CPMC-MPL700C	Software MP Loader	224 EUR
CPMC-MPL710	MPLoadMaker; Creates an auto transfer file with application data	763 EUR
CPMC-MPS700	MPScope	907 EUR



## Cables and Connectors

Ürün Kodu	Açıklama	Liste Fiyatı
JEPMC-W6002-A5-E	CN6 A/B MECHATROLINK II Communication Cable with connectors at both ends (0,5m)	67 EUR
JEPMC-W6002-01-E	CN6 A/B MECHATROLINK II Communication Cable with connectors at both ends (1m)	70 EUR
JEPMC-W6002-03-E	CN6 A/B MECHATROLINK II Communication Cable with connectors at both ends (2m)	81 EUR
JEPMC-W6002-05-E	CN6 A/B MECHATROLINK II Communication Cable with connectors at both ends (5m)	95 EUR
JEPMC-W6002-10-E	CN6 A/B MECHATROLINK II Communication Cable with connectors at both ends (10m)	113 EUR
JEPMC-W6002-20-E	CN6 A/B MECHATROLINK II Communication Cable with connectors at both ends (20m)	158 EUR
JEPMC-W6002-30-E	CN6 A/B MECHATROLINK II Communication Cable with connectors at both ends (30m)	301 EUR
JEPMC-W6002-40-E	CN6 A/B MECHATROLINK II Communication Cable with connectors at both ends (40m)	327 EUR
JEPMC-W6002-50-E	CN6 A/B MECHATROLINK II Communication Cable with connectors at both ends (50m)	355 EUR
JEPMC-W6003-A5-E-G5	CN6 A/B MECHATROLINK II Communication Cable with ring core (0,5m)	60 EUR
JEPMC-W6003-01-E-G5	CN6 A/B MECHATROLINK II Communication Cable with ring core (1m)	95 EUR
JEPMC-W6003-03-E-G5	CN6 A/B MECHATROLINK II Communication Cable with ring core (3m)	101 EUR
JEPMC-W6003-05-E-G5	CN6 A/B MECHATROLINK II Communication Cable with ring core (5m)	113 EUR
JEPMC-W6003-10-E-G5	CN6 A/B MECHATROLINK II Communication Cable with ring core (10m)	133 EUR
JEPMC-W6003-20-E-G5	CN6 A/B MECHATROLINK II Communication Cable with ring core (20m)	182 EUR
JEPMC-W6021-E	Ring Core for Mechatrolink-II cable	32 EUR
JEPMC-W6022-E	Terminator for Mechatrolink-II	27 EUR
JEPMC-W2040-A5-E	Connection Cable for SVA-01 with connectors on both ends (0,5m)	271 EUR
JEPMC-W2040-01-E	Connection Cable for SVA-01 with connectors on both ends (1m)	280 EUR
JEPMC-W2040-03-E	Connection Cable for SVA-01 with connectors on both ends (3m)	300 EUR
JEPMC-W5311-03-E	Com. cable RS-232C 03m with connector	140 EUR
JEPMC-W5311-15-E	Com. cable RS-232C 15m with connector	220 EUR
JEPMC-W2060-A5-E	I/O Cable for MP2300 Base Unit (0,5m)	97 EUR
JEPMC-W2060-01-E	I/O Cable for MP2300 Base Unit (1m)	101 EUR
JEPMC-W2060-03-E	I/O Cable for MP2300 Base Unit (3m)	119 EUR
JEPMC-W2061-A5-E	I/O Cable for LIO-01 & -02 with connector (0,5m)	155 EUR
JEPMC-W2061-01-E	I/O Cable for LIO-01 & -02 with connector (1m)	155 EUR
JEPMC-W2061-03-E	I/O Cable for LIO-01 & -02 with connector (3m)	164 EUR
JEPMC-W2063-A5-E	I/O Cable for CNTR-01 Module with connector (0,5m)	200 EUR
JEPMC-W2063-01-E	I/O Cable for CNTR-01 Module with connector (1m)	218 EUR
JEPMC-W2063-03-E	I/O Cable for CNTR-01 Module with connector (3m)	236 EUR
JEPMC-W6060-05-E	I/O Cable for LIO-4 LIO-5 DO-01 with connector (0,5m)	117 EUR
JEPMC-W6060-10-E	I/O Cable for LIO-4 LIO-5 DO-01 with connector (1m)	140 EUR
JEPMC-W6060-30-E	I/O Cable for LIO-4 LIO-5 DO-01 with connector (3m)	172 EUR
JEPMC-W6080-05-E	Input cable with a connector on the AI-01 end (0,5m)	327 EUR
JEPMC-W6080-10-E	Input cable with a connector on the AI-01 end (1m)	365 EUR
JEPMC-W6080-30-E	Input cable with a connector on the AI-01 end (3m)	387 EUR
JEPMC-W6090-05-E	Output Cable AI-01 (0,5m)	133 EUR
JEPMC-W6090-10-E	Output Cable AI-01 (1m)	161 EUR
JEPMC-W6090-30-E	Output Cable AI-01 (3m)	196 EUR



## Mechatrolink 2 I/O Modules

### Distributed I/O Module for Mechatrolink II

Ürün Kodu	Açıklama	Liste Fiyatı
JAMSC-IO2900-E	16-point input module	720 EUR
JAMSC-IO2910-E	16-point output (sink mode output) module	762 EUR
JAMSC-IO2920-E	8-point input and 8-point output (sink mode output) module	751 EUR
JAMSC-IO2950-E	8 contact outputs module	640 EUR
JEPMC-AN2900-E	Analog input: -10 V to +10 V, 4 channels	730 EUR
JEPMC-AN2910-E	AnalogOutput Module for MP2000	767 EUR
JEPMC-IO2310-E	24 VDC; 64-point input/output, sink mode output	964 EUR
JEPMC-IO2330-E	24 VDC, 64-point input/output, source mode output	964 EUR
JEPMC-PL2900-E	Reversible counter: 2 channels	663 EUR
JEPMC-PL2910-E	Pulse output: 2 channels	699 EUR

### I/O Cable

Ürün Kodu	Açıklama	Liste Fiyatı
JEPMC-W5410-05-E	I/O Cable for IO2310 & IO2330 with connector (5m)	179 EUR
JEPMC-W5410-10-E	I/O Cable for IO2310 & IO2330 with connector (10m)	196 EUR
JEPMC-W5410-30-E	I/O Cable for IO2310 & IO2330 with connector (30m)	238 EUR

### Options

Ürün Kodu	Açıklama	Liste Fiyatı
JZSP-BA01	Lithium battery ER3V 50W-05kW cable length 20mm	32 EUR
JEPMC-OP2300	Blank cover for base units MP2000/3000 Series	14 EUR
JEPMC-OP300	DIN rail attachment	27 EUR
CFI-128MDG	Compact Flash for Data Storage, 128 MB	Sorunuz
CFI-256MDG	Compact Flash for Data Storage, 256 MB	Sorunuz
CFI-512MDG	Compact Flash for Data Storage, 512 MB	Sorunuz
JEPMC-OP2300S-E	Unit Base Attachment for installing the machine controller	32 EUR
JEPMC-OP2400-E	Unit Base Attachment for installing the machine controller	53 EUR



## MP3200 Machine Controller

- @ High Performance Automation Controller for 16-62 controllable real axis + virtual axis + encoder axis
- @ Advanced control functions: Position control, gearing, speed control, torque control, CAM
- @ Accel/decel processing: Linear, Exponential, Moving Average
- @ 1 GHz, 64-bit processor
- @ 8 open slots for the optional modules using attachable rack
- @ Communication: Mechatrolink III, EtherNet (100 Mbps)
- @ Controller-Centric Commissioning using MECHATROLINK-III motion network
- @ Standards: UL, c-UL, CE

MP3200 High Performance Automation Controller

Ürün Kodu	Açıklama	Liste Fiyatı
JEPMC-CP3201-E	Motion Controller MP3200 Standard, CPU, 16 axis	3.237 EUR

### Power Supply Units for MP3200

Ürün Kodu	Açıklama	Liste Fiyatı
JEPMC-PSA3012-E	Power Supply 100V/200V for MP3200	1.409 EUR
JEPMC-PSD3012-E	Power Supply 24VDC for MP3200	1.409 EUR

### Base Units for MP3200

Ürün Kodu	Açıklama	Liste Fiyatı
JEPMC-BUB3003-E	Base Unit, 3 Slots for MP3200	525 EUR
JEPMC-BUB3005-E	Base Unit, 5 Slots for MP3200	659 EUR
JEPMC-BUB3008-E	Base Unit, 8 Slots for MP3200	704 EUR

### MP3200 Motion Control Modules

Ürün Kodu	Açıklama	Liste Fiyatı
JAPMC-MC2320-E	Motion Control Module SVC-01, 1 channel for Mechatrolink-III	1.139 EUR
JAPMC-PL2310-E	Motion Control Module PO-01, pulse output, 4-axis servo control	1.137 EUR
JAPMC-MC2300	Motion Control Module SVA-01, analog output, 2-axis servo control	1.095 EUR

### MP3200 Multiple-CPU Module (MPU-01)

Ürün Kodu	Açıklama	Liste Fiyatı
JAPMC-CP2700-E	Multiple-CPU Module (MPU-01) MECHATROLINK-III x1 port	2.498 EUR

### MP3200 Motion Control I/O Option Card

Ürün Kodu	Açıklama	Liste Fiyatı
JAPMC-AN2300-E	Analog Input Module AI-01, 8 channels	446 EUR
JAPMC-AN2310-E	Analog Output Module AO-01, 4 channels	484 EUR
JAPMC-DO2300-E	Output Module DO-01, 64 digital Output Point (Sink mode output)	446 EUR
JAPMC-IO2300-E	Input Output Module LIO-01, 16 I/O-Point Sink Mode Output, 1 Pulse Input	339 EUR
JAPMC-IO2301-E	Input Output Module LIO-02, 16 I/O-Point Source Mode Output, 1 Pulse Input	295 EUR
JAPMC-IO2303-E	Input Output Module LIO-04, 32 I/O-Point Sink Mode Output	464 EUR
JAPMC-IO2304-E	Input Output Module LIO-05, 32 I/O-Point Source Mode Output	425 EUR
JAPMC-IO2305-E	Input Output Module LIO-06, 8 I/O Digital (Sink mode output), 1 I/O Analog, 1 Pulse Counter, 1 channel/encoder input	526 EUR
JAPMC-PL2300-E	Counter Module CNTR-01, 2 channels	786 EUR

## MP Control Communication Modules for MP3200

Ürün Kodu	Açıklama	Liste Fiyatı
JAPMC-CM2310-E	217IF-01 Communication Module RS-232C / RS-422	369 EUR
JAPMC-CM2300-E	218IF-01 Communication Module for Ethernet	625 EUR
JAPMC-CM2302-E	218IF-02 Communication Module for RS-232-C	986 EUR
JAPMC-CM2320-E	260IF-01 Communication Module DeviceNet / RS-232-C	498 EUR
JAPMC-CM2330-E	261IF-01 Communication Module PROFIBUS / RS-232-C	551 EUR
JAPMC-CM2303-E	262IF-01 Communication Module for FL-NET	1.086 EUR
JAPMC-CM2304-E	263IF-01 Communication Module Ethernet / IP Communication	1.064 EUR
JAPMC-CM2305-E	264IF-01 Communication Module EtherCAT Communication	1.318 EUR
JAPMC-CM2390-E	265IF-01 Communication Module CompoNet Communication	1.181 EUR
JAPMC-CM2306-E	266IF-01 Communication Module PROFINET IO Controller, RT Conformance Class B (Master)	2.625 EUR
JAPMC-CM2307-E	266IF-02 Communication Module PROFINET IO Device, RT Conformance Class B (Slave)	1.575 EUR
JAPMC-CM2360-E	215AIF-01 Communication Module RS-232C/MPLINK communication	1.165 EUR
JAPMC-CM2361-E	215AIF-01 Communication Module RS-232C/CP-215 communication	Sorunuz

## Software Tools for MP3200

Ürün Kodu	Açıklama	Liste Fiyatı
CPMC-MPE780	Software Motion Works Engineering Tool Download Version 7 (licence key, for MP2000/3000)	1.086 EUR

## Mechatrolink III Network Components for MP3200

Ürün Kodu	Açıklama	Liste Fiyatı
JEPMC-MT2000-E	Hub, ML III Network, 8 Slave Ports	1.788 EUR
JEPMC-MT2010-E	Analyser, ML III Network	7.422 EUR
JEPMC-MT2020-E	Adapter, EtherNet to ML III	2.473 EUR
JEPMC-MTD2310-E	I/O Module, ML III Network, 64 in, 64 out	1.848 EUR
JEPMC-MTA2900-E	Analog Module, ML III Network, 8 Input	1.858 EUR
JEPMC-MTA2910-E	Analog Module, ML III Network, 4 Output	1.858 EUR
JEPMC-MTP2900-E	Pulse Module, ML III Network, 2 Input	2.228 EUR
JEPMC-MTP2910-E	Pulse Module, ML III Network, 4 Output	2.228 EUR

## Cables and Connectors

Ürün Kodu	Açıklama	Liste Fiyatı
JEPMC-W6012-A2-E	CN6 A/B MECHATROLINK-III communication cable connectors on both ends (0,2m)	53 EUR
JEPMC-W6012-A5-E	CN6 A/B MECHATROLINK-III communication cable connectors on both ends (0,5m)	56 EUR
JEPMC-W6012-01-E	CN6 A/B MECHATROLINK-III communication cable connectors on both ends (1m)	67 EUR
JEPMC-W6012-02-E	CN6 A/B MECHATROLINK-III communication cable connectors on both ends (2m)	87 EUR
JEPMC-W6012-03-E	CN6 A/B MECHATROLINK-III communication cable connectors on both ends (3m)	105 EUR
JEPMC-W6012-05-E	CN6 A/B MECHATROLINK-III communication cable connectors on both ends (5m)	149 EUR
JEPMC-W6012-10-E	CN6 A/B MECHATROLINK-III communication cable connectors on both ends (10m)	232 EUR
JEPMC-W6012-20-E	CN6 A/B MECHATROLINK-III communication cable connectors on both ends (20m)	414 EUR
JEPMC-W6012-30-E	CN6 A/B MECHATROLINK-III communication cable connectors on both ends (30m)	593 EUR
JEPMC-W6012-50-E	CN6 A/B MECHATROLINK-III communication cable connectors on both ends (50m)	955 EUR
JEPMC-W6013-10-E	CN6 A/B MECHATROLINK-III communication cable connectors on both ends and ring core (10m)	283 EUR
JEPMC-W6013-20-E	CN6 A/B MECHATROLINK-III communication cable connectors on both ends and ring core (20m)	456 EUR
JEPMC-W6013-30-E	CN6 A/B MECHATROLINK-III communication cable connectors on both ends and ring core (30m)	627 EUR
JEPMC-W6013-50-E	CN6 A/B MECHATROLINK-III communication cable connectors on both ends and ring core (50m)	978 EUR
JEPMC-W6014-A5-E	CN6 A/B MECHATROLINK-III communication cable with loose wire at one end (0,5m)	38 EUR
JEPMC-W6014-01-E	CN6 A/B MECHATROLINK-III communication cable with loose wire at one end (1m)	45 EUR
JEPMC-W6014-03-E	CN6 A/B MECHATROLINK-III communication cable with loose wire at one end (3m)	87 EUR
JEPMC-W6014-05-E	CN6 A/B MECHATROLINK-III communication cable with loose wire at one end (5m)	125 EUR
JEPMC-W6014-10-E	CN6 A/B MECHATROLINK-III communication cable with loose wire at one end (10m)	214 EUR
JEPMC-W6014-30-E	CN6 A/B MECHATROLINK-III communication cable with loose wire at one end (30m)	580 EUR
JEPMC-W6014-50-E	CN6 A/B MECHATROLINK-III communication cable with loose wire at one end (50m)	931 EUR
JZSP-CM3RRM0-00P2-E	MECHATROLINK-III communication cable with RJ45 connectors on both ends (0,2m)	81 EUR
JZSP-CM3RRM0-00P5-E	MECHATROLINK-III communication cable with RJ45 connectors on both ends (0,5m)	84 EUR
JZSP-CM3RRM0-01-E	MECHATROLINK-III communication cable with RJ45 connectors on both ends (1m)	91 EUR
JZSP-CM3RRM0-03-E	MECHATROLINK-III communication cable with RJ45 connectors on both ends (3m)	112 EUR
JZSP-CM3RRM0-05-E	MECHATROLINK-III communication cable with RJ45 connectors on both ends (5m)	129 EUR
JZSP-CM3RRM0-10-E	MECHATROLINK-III communication cable with RJ45 connectors on both ends (10m)	183 EUR
JZSP-CM3RR00-20-E	MECHATROLINK-III communication cable with RJ45 connectors on both ends (20m)	302 EUR
JZSP-CM3RR00-30-E	MECHATROLINK-III communication cable with RJ45 connectors on both ends (30m)	401 EUR
JZSP-CM3RRM0-00P2-E	MECHATROLINK-III communication cable with RJ45/IMI connectors (0,2m)	81 EUR

JZSP-CM3RMM0-00P5-E	MECHATROLINK-III communication cable with RJ45/IMI connectors (0,5m)	84 EUR
JZSP-CM3RMM0-01-E	MECHATROLINK-III communication cable with RJ45/IMI connectors (1m)	88 EUR
JZSP-CM3RMM0-03-E	MECHATROLINK-III communication cable with RJ45/IMI connectors (3m)	109 EUR
JZSP-CM3RMM0-05-E	MECHATROLINK-III communication cable with RJ45/IMI connectors (5m)	129 EUR
JZSP-CM3RMM0-10-E	MECHATROLINK-III communication cable with RJ45/IMI connectors (10m)	179 EUR
JZSP-CM3RMM0-20-E	MECHATROLINK-III communication cable with RJ45/IMI connectors (20m)	288 EUR
JZSP-CM3RMM0-30-E	MECHATROLINK-III communication cable with RJ45/IMI connectors (30m)	386 EUR
JEPMC-W2040-A5-E	Connection Cable for SVA-01 with connectors on both ends (0,5m)	271 EUR
JEPMC-W2040-01-E	Connection Cable for SVA-01 with connectors on both ends (1m)	280 EUR
JEPMC-W2040-03-E	Connection Cable for SVA-01 with connectors on both ends (3m)	300 EUR
JEPMC-W5311-03-E	Com. cable RS-232C 03m with connector	140 EUR
JEPMC-W5311-15-E	Com. cable RS-232C 15m with connector	220 EUR
JEPMC-W2061-A5-E	I/O Cable for LIO-01 & -02 with connector (0,5m)	155 EUR
JEPMC-W2061-01-E	I/O Cable for LIO-01 & -02 with connector (1m)	155 EUR
JEPMC-W2061-03-E	I/O Cable for LIO-01 & -02 with connector (3m)	164 EUR
JEPMC-W2064-A5-E	I/O Cable for LIO-06 Module with connector (0,5m)	149 EUR
JEPMC-W2064-01-E	I/O Cable for LIO-06 Module with connector (1m)	151 EUR
JEPMC-W2064-03-E	I/O Cable for LIO-06 Module with connector (3m)	187 EUR
JEPMC-W6060-05-E	I/O Cable for LIO-4 LIO-5 DO-01 with connector <b>(0,5m)</b>	117 EUR
JEPMC-W6060-10-E	I/O Cable for LIO-4 LIO-5 DO-01 with connector <b>(1m)</b>	140 EUR
JEPMC-W6060-30-E	I/O Cable for LIO-4 LIO-5 DO-01 with connector <b>(3m)</b>	172 EUR
JEPMC-W6080-05-E	Input cable with a connector on the AI-01 end <b>(0,5m)</b>	327 EUR
JEPMC-W6080-10-E	Input cable with a connector on the AI-01 end <b>(1m)</b>	365 EUR
JEPMC-W6080-30-E	Input cable with a connector on the AI-01 end <b>(3m)</b>	387 EUR
JEPMC-W6090-05-E	Output Cable AI-01 <b>(0,5m)</b>	133 EUR
JEPMC-W6090-10-E	Output Cable AI-01 <b>(1m)</b>	161 EUR
JEPMC-W6090-30-E	Output Cable AI-01 <b>(3m)</b>	196 EUR
JEPMC-W2063-A5-E	I/O Cable for CNTR-01 Module with connector (0,5m)	200 EUR
JEPMC-W2063-01-E	I/O Cable for CNTR-01 Module with connector (1m)	218 EUR
JEPMC-W2063-03-E	I/O Cable for CNTR-01 Module with connector (3m)	236 EUR



## MP3300 Modular Type Machine Controller

- @ Compact Machine Controller for 04-32 controllable servo axis
- @ Advanced control functions: Point-to-Point Control, Interpolation, Position Control, Speed Control, Torque Control, Synchronous Phase Control
- @ Language: Motion language, ladder language
- @ 2 different CPU versions (16 or 32 axis), 64-bit processor
- @ 2 base units incl. power supply available with 1 and 3 slots.
- @ Communication: Mechatrolink III, EtherNet (100 Mbps)
- @ Up to 15 MB application program capacity
- @ Transmission cycles: min. 125  $\mu$ s (4 stations)
- @ Standards: CE

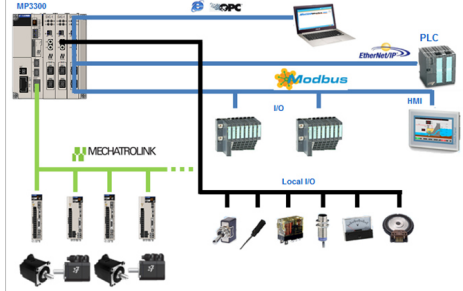

MP3300 Modular Machine Controller

Ürün Kodu	Açıklama	Liste Fiyatı
JAPMC-CP3301-1-E	Motion Controller MP3300, CPU-301, 16 axis, Scan time setting: Min. 250 $\mu$ s, Communications cycle*: Min. 250 $\mu$ s	1.632 EUR
JAPMC-CP3301-2-E	Motion Controller MP3300, CPU-301, 32 axis, Scan time setting: Min. 250 $\mu$ s, Communications cycle*: Min. 250 $\mu$ s	2.494 EUR
JAPMC-CP3302-1-E	Motion Controller MP3300, CPU-302, 16 axis, Scan time setting: Min. 125 $\mu$ s, Communications cycle*: Min. 125 $\mu$ s	4.572 EUR
JAPMC-CP3302-2-E	Motion Controller MP3300, CPU-302, 32 axis, Scan time setting: Min. 125 $\mu$ s, Communications cycle*: Min. 125 $\mu$ s	6.160 EUR

CPU-302 Module uses 2 slots, CPU Slot and Option Slot 1 for the Base Unit.

\*The cycle in which the host controller creates and sends references.

### Base Units for MP3300 incl. Power Supply

Ürün Kodu	Açıklama	Liste Fiyatı
JEPMC-BU3301-E	MP3300 Base Unit, 8 slot base incl. Power Supply 100/200VAC	1.050 EUR
JEPMC-BU3302-E	MP3300 Base Unit, 8 slot base incl. Power Supply 24V DC	875 EUR
JEPMC-BU3303-E	MP3300 Base Unit, 3 slot base incl. Power Supply 24V DC	692 EUR
JEPMC-BU3304-E	MP3300 Base Unit, 1 slot base incl. Power Supply 24V DC	440 EUR

### MP3300 Motion Control Modules

Ürün Kodu	Açıklama	Liste Fiyatı
JAPMC-MC2320-E	Motion Control Module SVC-01, 1 channel for Mechatrolink-III	1.139 EUR
JAPMC-PL2310-E	Motion Control Module PO-01, pulse output, 4-axis servo control	1.137 EUR
JAPMC-MC2300	Motion Control Module SVA-01, analog output, 2-axis servo control	1.095 EUR

### MP3300 Multiple-CPU Module (MPU-01)

Ürün Kodu	Açıklama	Liste Fiyatı
JAPMC-CP2700-E	Multiple-CPU Module (MPU-01) MECHATROLINK-III x1 port	2.498 EUR

### MP3300 Connection Module

Ürün Kodu	Açıklama	Liste Fiyatı
JAPMC-EX2200-E	Expansion Interface Module (EXIOIF)	456 EUR

### MP3300 Motion Control I/O Option Modules

Ürün Kodu	Açıklama	Liste Fiyatı
JAPMC-AN2300-E	Analog Input Module AI-01, 8 channels	446 EUR
JAPMC-AN2310-E	Analog Output Module AO-01, 4 channels	484 EUR
JAPMC-PL2300-E	Counter Module CNTR-01, 2 channels	786 EUR
JAPMC-DO2300-E	Output Module DO-01, 64 digital Output Point (Sink mode output)	446 EUR
JAPMC-IO2300-E	Input Output Module LIO-01, 16 I/O-Point Sink Mode Output, encoder input	339 EUR
JAPMC-IO2301-E	Input Output Module LIO-02, 16 I/O-Point Source Mode Output, encoder input	295 EUR
JAPMC-IO2303-E	Input Output Module LIO-04, 32 I/O-Point Sink Mode Output	464 EUR
JAPMC-IO2304-E	Input Output Module LIO-05, 32 I/O-Point Source Mode Output	425 EUR
JAPMC-IO2305-E	Input Output Module LIO-06, 8 I/O Digital, 1 I/O Analog, 1 Pulse Counter,	526 EUR

## MP Control Communication Modules for MP3300

Ürün Kodu	Açıklama	Liste Fiyatı
JAPMC-CM2310-E	217IF-01 Communication Module RS-232C / RS-422	369 EUR
JAPMC-CM2300-E	218IF-01 Communication Module for Ethernet	625 EUR
JAPMC-CM2302-E	218IF-02 Communication Module for RS-232-C	986 EUR
JAPMC-CM2320-E	260IF-01 Communication Module DeviceNet / RS-232-C	498 EUR
JAPMC-CM2330-E	261IF-01 Communication Module PROFIBUS / RS-232-C	551 EUR
JAPMC-CM2303-E	262IF-01 Communication Module for FL-NET	1.086 EUR
JAPMC-CM2304-E	263IF-01 Communication Module Ethernet / IP Communication	1.064 EUR
JAPMC-CM2305-E	264IF-01 Communication Module EtherCAT Communication	1.318 EUR
JAPMC-CM2390-E	265IF-01 Communication Module CompoNet Communication	1.181 EUR
JAPMC-CM2306-E	266IF-01 Communication Module PROFINET IO Controller, RT Conformance Class B (Master)	2.625 EUR
JAPMC-CM2307-E	266IF-02 Communication Module PROFINET IO Device, RT Conformance Class B (Slave)	1.575 EUR
JAPMC-CM2360-E	215AIF-01 Communication Module RS-232C/MPLINK communication	1.165 EUR
JAPMC-CM2361-E	215AIF-01 Communication Module RS-232C/CP-215 communication	Sorunuz

## Mechatrolink III Network Components for MP3300

Ürün Kodu	Açıklama	Liste Fiyatı
JEPMC-MT2000-E	Hub, ML III Network, 8 Slave Ports	1.788 EUR
JEPMC-MT2010-E	Analyser, ML III Network	7.422 EUR
JEPMC-MT2020-E	Adapter, EtherNet to ML III	2.473 EUR
JEPMC-MTD2310-E	I/O Module, ML III Network, 64 in, 64 out	1.848 EUR
JEPMC-MTA2900-E	Analog Module, ML III Network, 8 Input	1.858 EUR
JEPMC-MTA2910-E	Analog Module, ML III Network, 4 Output	1.858 EUR
JEPMC-MTP2900-E	Pulse Module, ML III Network, 2 Input	2.228 EUR
JEPMC-MTP2910-E	Pulse Module, ML III Network, 4 Output	2.228 EUR
JEPMC-GW3100-E	MECHATROLINK Compatible Gateway Module	Sorunuz

## Software Tools for MP3300

Ürün Kodu	Açıklama	Liste Fiyatı
CPMC-MPE780	Software Motion Works Engineering Tool Download Version 7 (licence key)	1.086 EUR

## Cables and Connectors

Ürün Kodu	Açıklama	Liste Fiyatı
JEPMC-W6012-A2-E	CN6 A/B MECHATROLINK-III communication cable connectors on both ends (0,2m)	53 EUR
JEPMC-W6012-A5-E	CN6 A/B MECHATROLINK-III communication cable connectors on both ends (0,5m)	56 EUR
JEPMC-W6012-01-E	CN6 A/B MECHATROLINK-III communication cable connectors on both ends (1m)	67 EUR
JEPMC-W6012-02-E	CN6 A/B MECHATROLINK-III communication cable connectors on both ends (2m)	87 EUR
JEPMC-W6012-03-E	CN6 A/B MECHATROLINK-III communication cable connectors on both ends (3m)	105 EUR
JEPMC-W6012-05-E	CN6 A/B MECHATROLINK-III communication cable connectors on both ends (5m)	149 EUR
JEPMC-W6012-10-E	CN6 A/B MECHATROLINK-III communication cable connectors on both ends (10m)	232 EUR
JEPMC-W6012-20-E	CN6 A/B MECHATROLINK-III communication cable connectors on both ends (20m)	414 EUR
JEPMC-W6012-30-E	CN6 A/B MECHATROLINK-III communication cable connectors on both ends (30m)	593 EUR
JEPMC-W6012-50-E	CN6 A/B MECHATROLINK-III communication cable connectors on both ends (50m)	955 EUR
JEPMC-W6013-10-E	CN6 A/B MECHATROLINK-III communication cable connectors on both ends and ring core (10m)	283 EUR
JEPMC-W6013-20-E	CN6 A/B MECHATROLINK-III communication cable connectors on both ends and ring core (20m)	456 EUR
JEPMC-W6013-30-E	CN6 A/B MECHATROLINK-III communication cable connectors on both ends and ring core (30m)	627 EUR
JEPMC-W6013-50-E	CN6 A/B MECHATROLINK-III communication cable connectors on both ends and ring core (50m)	978 EUR
JEPMC-W6014-A5-E	CN6 A/B MECHATROLINK-III communication cable with loose wire at one end (0,5m)	38 EUR
JEPMC-W6014-01-E	CN6 A/B MECHATROLINK-III communication cable with loose wire at one end (1m)	45 EUR
JEPMC-W6014-03-E	CN6 A/B MECHATROLINK-III communication cable with loose wire at one end (3m)	87 EUR
JEPMC-W6014-05-E	CN6 A/B MECHATROLINK-III communication cable with loose wire at one end (5m)	125 EUR
JEPMC-W6014-10-E	CN6 A/B MECHATROLINK-III communication cable with loose wire at one end (10m)	214 EUR
JEPMC-W6014-30-E	CN6 A/B MECHATROLINK-III communication cable with loose wire at one end (30m)	580 EUR
JEPMC-W6014-50-E	CN6 A/B MECHATROLINK-III communication cable with loose wire at one end (50m)	931 EUR
JZSP-CM3RRM0-00P2-E	MECHATROLINK-III communication cable with RJ45 connectors on both ends (0,2m)	81 EUR
JZSP-CM3RRM0-00P5-E	MECHATROLINK-III communication cable with RJ45 connectors on both ends (0,5m)	84 EUR
JZSP-CM3RRM0-01-E	MECHATROLINK-III communication cable with RJ45 connectors on both ends (1m)	91 EUR
JZSP-CM3RRM0-03-E	MECHATROLINK-III communication cable with RJ45 connectors on both ends (3m)	112 EUR
JZSP-CM3RRM0-05-E	MECHATROLINK-III communication cable with RJ45 connectors on both ends (5m)	129 EUR
JZSP-CM3RRM0-10-E	MECHATROLINK-III communication cable with RJ45 connectors on both ends (10m)	183 EUR
JZSP-CM3RR00-20-E	MECHATROLINK-III communication cable with RJ45 connectors on both ends (20m)	302 EUR
JZSP-CM3RR00-30-E	MECHATROLINK-III communication cable with RJ45 connectors on both ends (30m)	401 EUR
JZSP-CM3RMM0-00P2-E	MECHATROLINK-III communication cable with RJ45/IMI connectors (0,2m)	81 EUR
JZSP-CM3RMM0-00P5-E	MECHATROLINK-III communication cable with RJ45/IMI connectors (0,5m)	84 EUR
JZSP-CM3RMM0-01-E	MECHATROLINK-III communication cable with RJ45/IMI connectors (1m)	88 EUR
JZSP-CM3RMM0-03-E	MECHATROLINK-III communication cable with RJ45/IMI connectors (3m)	109 EUR
JZSP-CM3RMM0-05-E	MECHATROLINK-III communication cable with RJ45/IMI connectors (5m)	129 EUR
JZSP-CM3RMM0-10-E	MECHATROLINK-III communication cable with RJ45/IMI connectors (10m)	179 EUR
JZSP-CM3RM00-20-E	MECHATROLINK-III communication cable with RJ45/IMI connectors (20m)	288 EUR
JZSP-CM3RM00-30-E	MECHATROLINK-III communication cable with RJ45/IMI connectors (30m)	386 EUR

Ürün Kodu	Açıklama	Liste Fiyatı
JEPMC-W2040-A5-E	Connection Cable for SVA-01 with connectors on both ends (0,5m)	271 EUR
JEPMC-W2040-01-E	Connection Cable for SVA-01 with connectors on both ends (1m)	280 EUR
JEPMC-W2040-03-E	Connection Cable for SVA-01 with connectors on both ends (3m)	300 EUR
JEPMC-W5311-03-E	Com. cable RS-232C 03m with connector	140 EUR
JEPMC-W5311-15-E	Com. cable RS-232C 15m with connector	220 EUR
JEPMC-W2061-A5-E	I/O Cable for LIO-01 & -02 with connector (0,5m)	155 EUR
JEPMC-W2061-01-E	I/O Cable for LIO-01 & -02 with connector (1m)	155 EUR
JEPMC-W2061-03-E	I/O Cable for LIO-01 & -02 with connector (3m)	164 EUR
JEPMC-W2064-A5-E	I/O Cable for LIO-06 Module with connector (0,5m)	149 EUR
JEPMC-W2064-01-E	I/O Cable for LIO-06 Module with connector (1m)	151 EUR
JEPMC-W2064-03-E	I/O Cable for LIO-06 Module with connector (3m)	187 EUR
JEPMC-W6060-05-E	I/O Cable for LIO-4 LIO-5 DO-01 with connector (0,5m)	117 EUR
JEPMC-W6060-10-E	I/O Cable for LIO-4 LIO-5 DO-01 with connector (1m)	140 EUR
JEPMC-W6060-30-E	I/O Cable for LIO-4 LIO-5 DO-01 with connector (3m)	172 EUR
JEPMC-W6080-05-E	Input cable with a connector on the AI-01 end (0,5m)	327 EUR
JEPMC-W6080-10-E	Input cable with a connector on the AI-01 end (1m)	365 EUR
JEPMC-W6080-30-E	Input cable with a connector on the AI-01 end (3m)	387 EUR
JEPMC-W6090-05-E	Output Cable AI-01 (0,5m)	133 EUR
JEPMC-W6090-10-E	Output Cable AI-01 (1m)	161 EUR
JEPMC-W6090-30-E	Output Cable AI-01 (3m)	196 EUR
JEPMC-W2063-A5-E	I/O Cable for CNTR-01 Module with connector (0,5m)	200 EUR
JEPMC-W2063-01-E	I/O Cable for CNTR-01 Module with connector (1m)	218 EUR
JEPMC-W2063-03-E	I/O Cable for CNTR-01 Module with connector (3m)	236 EUR





### Servopack Sigma 7C Dual Axis Amplifier with build-in Controller

- @ Compact size dual axis amplifier with built in controller
- @ Standard MP programming
- @ Two internal Axis
- @ Four external axis via MECHATROLINK III
- @ STO Safety inputs
- @ MotionWorks Programming Environment
- @ MPE780 Ver.7 Lite

Mechatrolink 3 embedded SERVOPACK SGD7S-###B000F64

Ürün Kodu	Açıklama	Liste Fiyatı
SGD7C-1R6AMAA700	Sigma-7C 2x 200W with STO	3.381 EUR
SGD7C-2R8AMAA700	Sigma-7C 2x 400W with STO	3.460 EUR
SGD7C-5R5AMAA700	Sigma-7C 2x 750W with STO	3.698 EUR
JEPMC-OP3C01-E	Base Unit MBU-C01 for MP2000-series Option Module (one slot), Input Voltage: 24 VDC	431 EUR

#### Software Tools for Sigma-7C

Ürün Kodu	Açıklama	Liste Fiyatı
CPMC-MPE780 Lite	Software Motion Works Engineering Tool Download Version 7 (licence key, for Sigma-7C only)	Sorunuz
CPMC-MPE780	Software Motion Works Engineering Tool Download Version 7 (licence key, for MP2000/3000)	1.086 EUR

#### MP3200 Motion Control I/O Option Card

Ürün Kodu	Açıklama	Liste Fiyatı
JAPMC-AN2300-E	Analog Input Module AI-01, 8 channels	446 EUR
JAPMC-AN2310-E	Analog Output Module AO-01, 4 channels	484 EUR
JAPMC-DO2300-E	Output Module DO-01, 64 digital Output Point (Sink mode output)	446 EUR
JAPMC-IO2300-E	Input Output Module LIO-01, 16 I/O-Point Sink Mode Output, 1 Pulse Input	339 EUR
JAPMC-IO2301-E	Input Output Module LIO-02, 16 I/O-Point Source Mode Output, 1 Pulse Input	295 EUR
JAPMC-IO2303-E	Input Output Module LIO-04, 32 I/O-Point Sink Mode Output	464 EUR
JAPMC-IO2304-E	Input Output Module LIO-05, 32 I/O-Point Source Mode Output	425 EUR
JAPMC-IO2305-E	Input Output Module LIO-06, 8 I/O Digital (Sink mode output), 1 I/O Analog, 1 Pulse Counter, 1 channel/encoder input	526 EUR
JAPMC-PL2300-E	Counter Module CNTR-01, 2 channels	786 EUR

#### MP Control Communication Modules for MP3200

Ürün Kodu	Açıklama	Liste Fiyatı
JAPMC-CM2310-E	217IF-01 Communication Module RS-232C / RS-422	369 EUR
JAPMC-CM2300-E	218IF-01 Communication Module for Ethernet	625 EUR
JAPMC-CM2302-E	218IF-02 Communication Module for RS-232-C	986 EUR
JAPMC-CM2320-E	260IF-01 Communication Module DeviceNet / RS-232-C	498 EUR
JAPMC-CM2330-E	261IF-01 Communication Module PROFIBUS / RS-232-C	551 EUR
JAPMC-CM2303-E	262IF-01 Communication Module for FL-NET	1.086 EUR
JAPMC-CM2304-E	263IF-01 Communication Module Ethernet / IP Communication	1.064 EUR
JAPMC-CM2305-E	264IF-01 Communication Module EtherCAT Communication	1.318 EUR
JAPMC-CM2390-E	265IF-01 Communication Module CompoNet Communication	1.181 EUR
JAPMC-CM2306-E	266IF-01 Communication Module PROFINET IO Controller, RT Conformance Class B (Master)	2.625 EUR
JAPMC-CM2307-E	266IF-02 Communication Module PROFINET IO Device, RT Conformance Class B (Slave)	1.575 EUR

## SERVOPACK accesories SGD7C-####20

Ürün Kodu	Açıklama	Liste Fiyatı
JUSP-TA36P-E	CN1 I/O Connector with Terminal Block 0.5m	222 EUR
JUSP-TA36P-1-E	CN1 I/O Connector with Terminal Block 1m	317 EUR
JUSP-TA36P-2-E	CN1 I/O Connector with Terminal Block 2m	375 EUR
JZSP-CSI03-1-E	CN1 I/O connector with flying lead cable 1m	112 EUR
JZSP-CSI03-2-E	CN1 I/O connector with flying lead cable 2m	141 EUR
JZSP-CSI03-3-E	CN1 I/O connector with flying lead cable 3m	165 EUR
JUSP-OP05A-1-E	CN3 Digital Operator with connection cable 1m	432 EUR
JZSP-CVS05-A3-E	CN3 Digital Operator convertor cable with Connectors at both ends 0.3m	161 EUR
JZSP-CVS07-A3-E	CN3 Digital Operator convertor cable with lock screws 0.3m	215 EUR
JZSP-CA01-E	CN5 Cable for Analog Monitor 1m	20 EUR
JUSP-TA50PG-E	CN1 I/O Connector with Terminal Block 0.5m	348 EUR
JUSP-TA50PG-1-E	CN1 I/O Connector with Terminal Block 1m	443 EUR
JUSP-TA50PG-2-E	CN1 I/O Connector with Terminal Block 2m	449 EUR
JZSP-CSI01-1-E	CN1 I/O connector with flying lead cable 1m	125 EUR
JZSP-CSI01-2-E	CN1 I/O connector with flying lead cable 2m	149 EUR
JZSP-CSI01-3-E	CN1 I/O connector with flying lead cable 3m	158 EUR
JZSP-CSI9-1-E	CN1 Connector Kit for I/O signal	53 EUR
JUSP-TA50PG-E	CN13 I/O Connector with Terminal Block 0.5m	348 EUR
JUSP-TA50PG-1-E	CN13 I/O Connector with Terminal Block 1m	443 EUR
JUSP-TA50PG-2-E	CN13 I/O Connector with Terminal Block 2m	449 EUR
JZSP-CSI01-1-E	CN13 I/O connector with flying lead cable 1m	125 EUR
JZSP-CSI01-2-E	CN13 I/O connector with flying lead cable 2m	149 EUR
JZSP-CSI01-3-E	CN13 I/O connector with flying lead cable 3m	158 EUR
JZSP-CVS06-02-E	CN7 connection cable for PC 2.5m	113 EUR
KLBLUE 4-13.5 SET	Shielding clamp SET for motor cable 4-13.5mm <sup>2</sup> for Servopacks: Sigma 7 200V up to 750W, Sigma-5 200V up to 750W	10 EUR
JZSP-CVH03-03-E-G5	CN8 Cable with connector for safety functions 3m	60 EUR
JEPMC-W5311-03-E	Com. cable RS-232C 03m with connector	140 EUR
JEPMC-W5311-15-E	Com. cable RS-232C 15m with connector	220 EUR
JEPMC-W2061-03-E	I/O Cable for LIO-01 & -02 with connector (3m)	164 EUR
JEPMC-W2064-A5-E	I/O Cable for LIO-06 Module with connector (0,5m)	149 EUR
JEPMC-W2064-01-E	I/O Cable for LIO-06 Module with connector (1m)	151 EUR
JEPMC-W2064-03-E	I/O Cable for LIO-06 Module with connector (3m)	187 EUR
JEPMC-W6060-05-E	I/O Cable for LIO-4 LIO-5 DO-01 with connector (0,5m)	117 EUR
JEPMC-W6060-10-E	I/O Cable for LIO-4 LIO-5 DO-01 with connector (1m)	140 EUR
JEPMC-W6060-30-E	I/O Cable for LIO-4 LIO-5 DO-01 with connector (3m)	172 EUR
JEPMC-W6080-05-E	Input cable with a connector on the AI-01 end (0,5m)	327 EUR
JEPMC-W6080-10-E	Input cable with a connector on the AI-01 end (1m)	365 EUR
JEPMC-W6080-30-E	Input cable with a connector on the AI-01 end (3m)	387 EUR
JEPMC-W6090-05-E	Output Cable AI-01 (0,5m)	133 EUR
JEPMC-W6090-10-E	Output Cable AI-01 (1m)	161 EUR
JEPMC-W6090-30-E	Output Cable AI-01 (3m)	196 EUR
JEPMC-W2063-A5-E	I/O Cable for CNTR-01 Module with connector (0,5m)	200 EUR
JEPMC-W2063-01-E	I/O Cable for CNTR-01 Module with connector (1m)	218 EUR
JEPMC-W2063-03-E	I/O Cable for CNTR-01 Module with connector (3m)	236 EUR

**MECHATROLINK 3 Cables and Connectors**

Ürün Kodu	Açıklama	Liste Fiyatı
JEPMC-W6012-A2-E	CN6 A/B MECHATROLINK-III communication cable connectors on both ends (0,2m)	53 EUR
JEPMC-W6012-A5-E	CN6 A/B MECHATROLINK-III communication cable connectors on both ends (0,5m)	56 EUR
JEPMC-W6012-01-E	CN6 A/B MECHATROLINK-III communication cable connectors on both ends (1m)	67 EUR
JEPMC-W6012-02-E	CN6 A/B MECHATROLINK-III communication cable connectors on both ends (2m)	87 EUR
JEPMC-W6012-03-E	CN6 A/B MECHATROLINK-III communication cable connectors on both ends (3m)	105 EUR
JEPMC-W6012-05-E	CN6 A/B MECHATROLINK-III communication cable connectors on both ends (5m)	149 EUR
JEPMC-W6012-10-E	CN6 A/B MECHATROLINK-III communication cable connectors on both ends (10m)	232 EUR
JEPMC-W6012-20-E	CN6 A/B MECHATROLINK-III communication cable connectors on both ends (20m)	414 EUR
JEPMC-W6012-30-E	CN6 A/B MECHATROLINK-III communication cable connectors on both ends (30m)	593 EUR
JEPMC-W6012-50-E	CN6 A/B MECHATROLINK-III communication cable connectors on both ends (50m)	955 EUR
JEPMC-W6013-10-E	CN6 A/B MECHATROLINK-III communication cable connectors on both ends and ring core (10m)	283 EUR
JEPMC-W6013-20-E	CN6 A/B MECHATROLINK-III communication cable connectors on both ends and ring core (20m)	456 EUR
JEPMC-W6013-30-E	CN6 A/B MECHATROLINK-III communication cable connectors on both ends and ring core (30m)	627 EUR
JEPMC-W6013-50-E	CN6 A/B MECHATROLINK-III communication cable connectors on both ends and ring core (50m)	978 EUR
JEPMC-W6014-A5-E	CN6 A/B MECHATROLINK-III communication cable with loose wire at one end (0,5m)	38 EUR
JEPMC-W6014-01-E	CN6 A/B MECHATROLINK-III communication cable with loose wire at one end (1m)	45 EUR
JEPMC-W6014-03-E	CN6 A/B MECHATROLINK-III communication cable with loose wire at one end (3m)	87 EUR
JEPMC-W6014-05-E	CN6 A/B MECHATROLINK-III communication cable with loose wire at one end (5m)	125 EUR
JEPMC-W6014-10-E	CN6 A/B MECHATROLINK-III communication cable with loose wire at one end (10m)	214 EUR
JEPMC-W6014-30-E	CN6 A/B MECHATROLINK-III communication cable with loose wire at one end (30m)	580 EUR
JEPMC-W6014-50-E	CN6 A/B MECHATROLINK-III communication cable with loose wire at one end (50m)	931 EUR
JZSP-CM3RMM0-00P2-E	MECHATROLINK-III communication cable with RJ45/IMI connectors (0,2m)	81 EUR
JZSP-CM3RMM0-00P5-E	MECHATROLINK-III communication cable with RJ45/IMI connectors (0,5m)	84 EUR
JZSP-CM3RMM0-01-E	MECHATROLINK-III communication cable with RJ45/IMI connectors (1m)	88 EUR
JZSP-CM3RMM0-03-E	MECHATROLINK-III communication cable with RJ45/IMI connectors (3m)	109 EUR
JZSP-CM3RMM0-05-E	MECHATROLINK-III communication cable with RJ45/IMI connectors (5m)	129 EUR
JZSP-CM3RMM0-10-E	MECHATROLINK-III communication cable with RJ45/IMI connectors (10m)	179 EUR
JZSP-CM3RMM0-20-E	MECHATROLINK-III communication cable with RJ45/IMI connectors (20m)	288 EUR
JZSP-CM3RMM0-30-E	MECHATROLINK-III communication cable with RJ45/IMI connectors (30m)	386 EUR



## Servopack Sigma 7 - Analog / Pulse Type

- @ 200 VAC to 240 VAC, -15% to +10%, 50 Hz/60 Hz
- @ Single phase possible for 0.05-0.75 & 1.50kW
- @ Power: 0.05kW - 15kW (recommended up to 1.50kW)
- @ Speed frequency response: 3.1kHz
- @ Ripple compensation, vibration suppression
- @ One amplifier for linear and rotary motors
- @ UL-, CE-conform, RoHS-conform
- @ Safety SIL3 PLe (Category 3) for STO

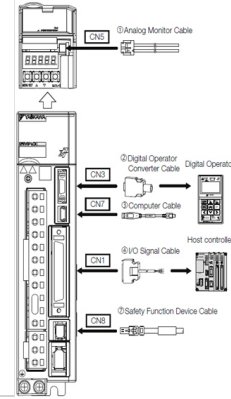

### Analog/Pulse SERVOPACK SGD7S-####00

Ürün Kodu	Açıklama	Liste Fiyatı
SGD7S-R70A00A	Sigma 7 Servo Amplifier 0.05kW 1/3ph 230V Analog/Pulse	744 EUR
SGD7S-R90A00A	Sigma 7 Servo Amplifier 0.10kW 1/3ph 230V Analog/Pulse	744 EUR
SGD7S-1R6A00A	Sigma 7 Servo Amplifier 0.20kW 1/3ph 230V Analog/Pulse	789 EUR
SGD7S-2R8A00A	Sigma 7 Servo Amplifier 0.40kW 1/3ph 230V Analog/Pulse	828 EUR
SGD7S-5R5A00A	Sigma 7 Servo Amplifier 0.75kW 1/3ph 230V Analog/Pulse	854 EUR
SGD7S-120A00A008	Sigma 7 Servo Amplifier 1.50kW 1ph 230V Analog/Pulse	1.271 EUR

Power sizes incl. and above 1,5kW in 3ph. 200V are existing and can be quoted on request only!

### Analog/Pulse SERVOPACK Accessories SGD7S-####00

Ürün Kodu	Açıklama	Liste Fiyatı
JUSP-TA50PG-E	CN1 I/O Connector with Terminal Block 0.5m	348 EUR
JUSP-TA50PG-1-E	CN1 I/O Connector with Terminal Block 1m	443 EUR
JUSP-TA50PG-2-E	CN1 I/O Connector with Terminal Block 2m	449 EUR
JZSP-CSI01-1-E	CN1 I/O connector with flying lead cable 1m	125 EUR
JZSP-CSI01-2-E	CN1 I/O connector with flying lead cable 2m	149 EUR
JZSP-CSI01-3-E	CN1 I/O connector with flying lead cable 3m	158 EUR
JZSP-CSI9-1-E	CN1 Connector Kit for I/O signal	53 EUR
CBK-U-MP2B-A5	Connector Terminal Converter for I/O Signals, 50-pin, length 0,5m	221 EUR
CBK-U-MP2B-01	Connector Terminal Converter for I/O Signals, 50-pin, length 1,0m	242 EUR
CBK-U-MP2A-01	Connector Terminal Converter for LIO-01/LIO-02 Module, length 1,0m	295 EUR
CBK-U-MP2C-01	Terminal Block Kit for MP3200 I/O, 64-Point I/O Module, 1,0m	513 EUR
JZSP-CVS05-A3-E	CN3 Digital Operator convertor cable 0.3m	161 EUR
JUSP-OP05A-1-E	CN3 Digital Operator with connection cable 1m	432 EUR
JZSP-CA01-E	CN5 Cable for Analog Monitor 1m	20 EUR
JZSP-CVS06-02-E	CN7 connection cable for PC 2.5m	113 EUR
JZSP-CVH03-03-E-G5	CN8 Cable with connector for safety functions 3m	60 EUR
2013595-1	Safety Connector Kit for CN 8	18 EUR
JZSP-CLP70-03-E-G5	CN31 Cable for connecting serial converter for Fully-closed for Sigma-7 (3m)	161 EUR
JZSP-CLP70-05-E-G5	CN31 Cable for connecting serial converter for Fully-closed for Sigma-7 (5m)	200 EUR
JZSP-CLP70-10-E-G5	CN31 Cable for connecting serial converter for Fully-closed for Sigma-7 (10m)	295 EUR
JZSP-CLP70-15-E-G5	CN31 Cable for connecting serial converter for Fully-closed for Sigma-7 (15m)	389 EUR
KLBLUE 4-13.5 SET	Shielding clamp SET for motor cable 4-13.5mm <sup>2</sup> for Servopacks: Sigma 7 200V up to 750W, Sigma-5 200V up to 750W	10 EUR
KLBLUE 4-13.5 SC	Shielding clamp for motor cable 4-13.5mm <sup>2</sup> for Servopacks: Sigma 7 400V up to 3.0 kW, Sigma 7 200V 1.5 kW 1ph, Sigma 5 200V 1.5 kW 1ph	7 EUR
EUOP-M92019	Sigma-7 200V connector kit for servopacks SGD7S-R70Axxx to SGD7S-2R8Axxx, Including: Main power connector, Motor power connector, Safety jumper, Lever tool & cable bridges	28 EUR
EUOP-M92020	Sigma-7 200V connector kit for servopack SGD7S-5R5Axxx, Including: Main power connector, Motor power connector, Safety jumper, Lever tool & cable bridges	32 EUR
JUSP-RA04-E	Resistor for Sigma-7 for SGD7S-470A Type 200V Servo Amplifier	432 EUR
JUSP-RA05-E	Resistor for Sigma-7 for SGD7S-550A, 590A, 780A Type 200V Servo Amplifier	692 EUR
JZDP-H003-XXX	Serial Converter for external Encoder Heidenhain, 8 bit resolution	521 EUR
JZDP-H005-XXX	Serial Converter for external Encoder Renishaw, 8 bit resolution	521 EUR
JZDP-J003-XXX	Serial Converter for external Encoder Heidenhain, 12 bit resolution	573 EUR
JZDP-J005-XXX	Serial Converter for external Encoder Renishaw, 12 bit resolution	573 EUR
SGDV-OSA01A	Advanced Safety Option Card	179 EUR
SGDV-OZA01A	Mounting Kit for Sigma-7 Option Cards	46 EUR
SGDV-OFA01A	Fully-closed Loop Option Card Sigma-7	81 EUR

## Filters for SGD7S Servopacks (Combi Filters including control power)

Ürün Kodu	Açıklama	Liste Fiyatı
FESS-B005A	Noise Filter for Sigma-7 1ph for SGD7S-R70A - 2R8A Type 230V Servo Amplifier	91 EUR
FESS-B009A	Noise Filter for Sigma-7 1ph for SGD7S-5R5A & 7R6A Type 230V Servo Amplifier	119 EUR
FESS-B016A	Noise Filter for Sigma-7 1ph for SGD7S-120A Type 230V Servo Amplifier	179 EUR

These Filters are compatible with Sigma V

## Reactors for SGD7S Servopacks

Ürün Kodu	Açıklama	Liste Fiyatı
X5060	DC Reactors for Sigma-7 for SGD7S-120A Type 230V Servo Amplifier	238 EUR
X5061	DC Reactors for Sigma-7 for SGD7S-R70A - 7R6A Type 230V Servo Amplifier	228 EUR



## Servopack Sigma 7 - Mechatrolink II Type

- @ 200 VAC to 240 VAC, -15% to +10%, 50 Hz/60 Hz
- @ Single phase possible for 0.05-0.75 & 1.50kW
- @ Power: 0.05kW - 15kW (recommended up to 1.50kW)
- @ Speed frequency response: 3.1kHz
- @ Ripple compensation, vibration suppression
- @ One amplifier for linear and rotary motors
- @ UL-, CE-conform, RoHS-conform
- @ Safety SIL3 PLe (Category 3) for STO

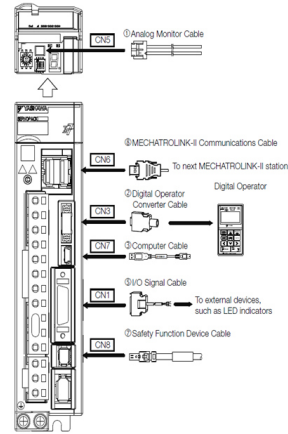

Mechatrolink II SERVOPACK SGD7S-####10

Ürün Kodu	Açıklama	Liste Fiyatı
SGD7S-R70A10A	Sigma 7 Servo Amplifier 0.05kW 1/3ph 230V Mechatrolink II	744 EUR
SGD7S-R90A10A	Sigma 7 Servo Amplifier 0.10kW 1/3ph 230V Mechatrolink II	744 EUR
SGD7S-1R6A10A	Sigma 7 Servo Amplifier 0.20kW 1/3ph 230V Mechatrolink II	799 EUR
SGD7S-2R8A10A	Sigma 7 Servo Amplifier 0.40kW 1/3ph 230V Mechatrolink II	849 EUR
SGD7S-5R5A10A	Sigma 7 Servo Amplifier 0.75kW 1/3ph 230V Mechatrolink II	989 EUR
SGD7S-120A10A008	Sigma 7 Servo Amplifier 1.50kW 1ph 230V Mechatrolink II	1.205 EUR

Mechatrolink II SERVOPACK accesories SGD7S-####10

Ürün Kodu	Açıklama	Liste Fiyatı
JUSP-TA26P-E	CN1 I/O Connector with Terminal Block 0.5m	425 EUR
JUSP-TA26P-1-E	CN1 I/O Connector with Terminal Block 1m	452 EUR
JUSP-TA26P-2-E	CN1 I/O Connector with Terminal Block 2m	474 EUR
SBK-U-VBA-01	Terminal block for I/O Signals, 26 Pins, length 1 m	229 EUR
JZSP-CSI02-1-E	CN1 I/O connector with flying lead cable 1m	99 EUR
JZSP-CSI02-2-E	CN1 I/O connector with flying lead cable 2m	121 EUR
JZSP-CSI02-3-E	CN1 I/O connector with flying lead cable 3m	151 EUR
JZSP-CSI9-2-E	CN1 connector kit for I/O signals	42 EUR
JZSP-CVS05-A3-E	CN3 Digital Operator convertor cable 0.3m	161 EUR
JUSP-OP05A-1-E	CN3 Digital Operator with connection cable 1m	432 EUR
JZSP-CA01-E	CN5 Cable for Analog Monitor 1m	20 EUR
JEPMC-W6002-A5-E	CN6 A/B MECHATROLINK II Communication Cable with connectors at both ends (0,5m)	67 EUR
JEPMC-W6002-01-E	CN6 A/B MECHATROLINK II Communication Cable with connectors at both ends (1m)	70 EUR
JEPMC-W6002-03-E	CN6 A/B MECHATROLINK II Communication Cable with connectors at both ends (2m)	81 EUR
JEPMC-W6002-05-E	CN6 A/B MECHATROLINK II Communication Cable with connectors at both ends (5m)	95 EUR
JEPMC-W6002-10-E	CN6 A/B MECHATROLINK II Communication Cable with connectors at both ends (10m)	113 EUR
JEPMC-W6002-20-E	CN6 A/B MECHATROLINK II Communication Cable with connectors at both ends (20m)	158 EUR
JEPMC-W6002-30-E	CN6 A/B MECHATROLINK II Communication Cable with connectors at both ends (30m)	301 EUR
JEPMC-W6002-40-E	CN6 A/B MECHATROLINK II Communication Cable with connectors at both ends (40m)	327 EUR
JEPMC-W6002-50-E	CN6 A/B MECHATROLINK II Communication Cable with connectors at both ends (50m)	355 EUR
JEPMC-W6003-A5-E-G5	CN6 A/B MECHATROLINK II Communication Cable with ring core (0,5m)	60 EUR
JEPMC-W6003-01-E-G5	CN6 A/B MECHATROLINK II Communication Cable with ring core (1m)	95 EUR
JEPMC-W6003-03-E-G5	CN6 A/B MECHATROLINK II Communication Cable with ring core (3m)	101 EUR
JEPMC-W6003-05-E-G5	CN6 A/B MECHATROLINK II Communication Cable with ring core (5m)	113 EUR
JEPMC-W6003-10-E-G5	CN6 A/B MECHATROLINK II Communication Cable with ring core (10m)	133 EUR
JEPMC-W6003-20-E-G5	CN6 A/B MECHATROLINK II Communication Cable with ring core (20m)	182 EUR
JEPMC-W6022-E	CN6 A/B MECHATROLINK II Terminator	27 EUR
JZSP-CVS06-02-E	CN7 connection cable for PC 2.5m	113 EUR
JZSP-CVH03-03-E-G5	CN8 Cable with connecor for safety functions 3m	60 EUR
2013595-1	CN8 Connector kit for Safety	18 EUR
JZSP-CLP70-03-E-G5	CN31 Cable for connecting serial converter for Fully-closed for Sigma-7 (3m)	161 EUR
JZSP-CLP70-05-E-G5	CN31 Cable for connecting serial converter for Fully-closed for Sigma-7 (5m)	200 EUR
JZSP-CLP70-10-E-G5	CN31 Cable for connecting serial converter for Fully-closed for Sigma-7 (10m)	295 EUR
JZSP-CLP70-15-E-G5	CN31 Cable for connecting serial converter for Fully-closed for Sigma-7 (15m)	389 EUR

KLBU 4-13.5 SET	Shielding clamp SET for motor cable 4-13.5mm <sup>2</sup> for Servopacks: Sigma 7 200V up to 750W, Sigma-5 200V up to 750W	10 EUR
KLBU 4-13.5 SC	Shielding clamp for motor cable 4-13.5mm <sup>2</sup> for Servopacks: Sigma 7 400V up to 3.0 kW, Sigma 7 200V 1.5 kW 1ph, Sigma 5 200V 1.5 kW 1ph	7 EUR
EUOP-M92019	Sigma-7 200V connector kit for servopacks SGD7S-R70Axxx to SGD7S-2R8Axxx, Including: Main power connector, Motor power connector, Safety jumper, Lever tool & cable bridges	28 EUR
EUOP-M92020	Sigma-7 200V connector kit for servopack SGD7S-5R5Axxx, Including: Main power connector, Motor power connector, Safety jumper, Lever tool & cable bridges	32 EUR
JUSP-RA04-E	Resistor for Sigma-7 for SGD7S-470A Type 200V Servo Amplifier	432 EUR
JUSP-RA05-E	Resistor for Sigma-7 for SGD7S-550A, 590A, 780A Type 200V Servo Amplifier	692 EUR
JZDP-H003-XXX	Serial Converter for external Encoder Heidenhain, 8 bit resolution	521 EUR
JZDP-H005-XXX	Serial Converter for external Encoder Renishaw, 8 bit resolution	521 EUR
JZDP-J003-XXX	Serial Converter for external Encoder Heidenhain, 12 bit resolution	573 EUR
JZDP-J005-XXX	Serial Converter for external Encoder Renishaw, 12 bit resolution	573 EUR
SGDV-OSA01A	Advanced Safety Option Card	179 EUR
SGDV-OZA01A	Mounting Kit for Sigma-7 Option Cards	46 EUR
SGDV-OFA01A	Fully-closed Loop Option Card Sigma-7	81 EUR

#### Filters for SGD7S Servopacks (Combi Filters including control power)

Ürün Kodu	Açıklama	Liste Fiyatı
FESS-B005A	Noise Filter for Sigma-7 1ph for SGD7S-R70A - 2R8A Type 230V Servo Amplifier	91 EUR
FESS-B009A	Noise Filter for Sigma-7 1ph for SGD7S-5R5A & 7R6A Type 230V Servo Amplifier	119 EUR
FESS-B016A	Noise Filter for Sigma-7 1ph for SGD7S-120A Type 230V Servo Amplifier	179 EUR

These Filters are compatible with Sigma V

#### Reactors for SGD7S Servopacks

Ürün Kodu	Açıklama	Liste Fiyatı
X5060	DC Reactors for Sigma-7 for SGD7S-120A Type 230V Servo Amplifier	238 EUR
X5061	DC Reactors for Sigma-7 for SGD7S-R70A - 7R6A Type 230V Servo Amplifier	228 EUR



## Servopack Sigma 7 - Mechatrolink III Type Single Axis

- @ 200 VAC to 240 VAC, -15% to +10%, 50 Hz/60 Hz
- @ Single phase possible for 0.05-0.75 & 1.50kW
- @ Power: 0.05kW - 15kW (recommended up to 1.50kW)
- @ Speed frequency response: 3.1kHz
- @ Ripple compensation, vibration suppression
- @ One amplifier for linear and rotary motors
- @ UL-, CE-conform, RoHS-conform
- @ Safety SIL3 PLe (Category 3) for STO

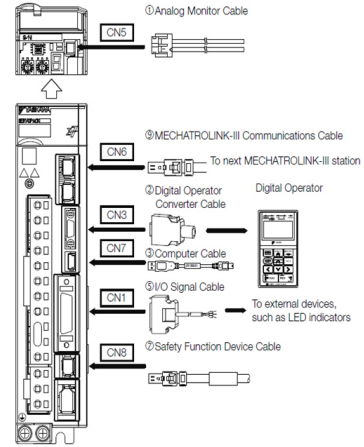

Mechatrolink III SERVOPACK SGD7S-####20

Ürün Kodu	Açıklama	Liste Fiyatı
SGD7S-R70A20A	Sigma 7 Servo Amplifier 0.05kW 1/3ph 230V Mechatrolink III	782 EUR
SGD7S-R90A20A	Sigma 7 Servo Amplifier 0.10kW 1/3ph 230V Mechatrolink III	782 EUR
SGD7S-1R6A20A	Sigma 7 Servo Amplifier 0.20kW 1/3ph 230V Mechatrolink III	828 EUR
SGD7S-2R8A20A	Sigma 7 Servo Amplifier 0.40kW 1/3ph 230V Mechatrolink III	881 EUR
SGD7S-5R5A20A	Sigma 7 Servo Amplifier 0.75kW 1/3ph 230V Mechatrolink III	1.108 EUR
SGD7S-120A20A008	Sigma 7 Servo Amplifier 1.50kW 1ph 230V Mechatrolink III	1.315 EUR

Power sizes incl. and above 1,5kW in 3ph. 200V are existing and can be quoted on request only!

Mechatrolink III SERVOPACK accesories SGD7S-####20

Ürün Kodu	Açıklama	Liste Fiyatı
JJSP-TA26P-E	CN1 I/O Connector with Terminal Block 0.5m	425 EUR
JJSP-TA26P-1-E	CN1 I/O Connector with Terminal Block 1m	452 EUR
JJSP-TA26P-2-E	CN1 I/O Connector with Terminal Block 2m	474 EUR
SBK-U-VBA-01	Terminal block for I/O Signals, 26 Pins, length 1 m	229 EUR
JZSP-CSI02-1-E	CN1 I/O connector with flying lead cable 1m	99 EUR
JZSP-CSI02-2-E	CN1 I/O connector with flying lead cable 2m	121 EUR
JZSP-CSI02-3-E	CN1 I/O connector with flying lead cable 3m	151 EUR
JZSP-CSI9-2-E	CN1 connector kit for I/O signals	42 EUR
JJSP-OP05A-1-E	CN3 Digital Operator with connection cable 1m	432 EUR
JZSP-CVS05-A3-E	CN3 Digital Operator convertor cable with Connectors at both ends 0.3m	161 EUR
JZSP-CVS07-A3-E	CN3 Digital Operator convertor cable with lock screws 0.3m	215 EUR
JZSP-CA01-E	CN5 Cable for Analog Monitor 1m	20 EUR
JEPMC-W6012-A2-E	CN6 A/B MECHATROLINK-III communication cable connectors on both ends (0,2m)	53 EUR
JEPMC-W6012-A5-E	CN6 A/B MECHATROLINK-III communication cable connectors on both ends (0,5m)	56 EUR
JEPMC-W6012-01-E	CN6 A/B MECHATROLINK-III communication cable connectors on both ends (1m)	67 EUR
JEPMC-W6012-02-E	CN6 A/B MECHATROLINK-III communication cable connectors on both ends (2m)	87 EUR
JEPMC-W6012-03-E	CN6 A/B MECHATROLINK-III communication cable connectors on both ends (3m)	105 EUR
JEPMC-W6012-05-E	CN6 A/B MECHATROLINK-III communication cable connectors on both ends (5m)	149 EUR
JEPMC-W6012-10-E	CN6 A/B MECHATROLINK-III communication cable connectors on both ends (10m)	232 EUR
JEPMC-W6012-20-E	CN6 A/B MECHATROLINK-III communication cable connectors on both ends (20m)	414 EUR
JEPMC-W6012-30-E	CN6 A/B MECHATROLINK-III communication cable connectors on both ends (30m)	593 EUR
JEPMC-W6012-50-E	CN6 A/B MECHATROLINK-III communication cable connectors on both ends (50m)	955 EUR
JEPMC-W6013-10-E	CN6 A/B MECHATROLINK-III communication cable connectors on both ends and ring core (10m)	283 EUR
JEPMC-W6013-20-E	CN6 A/B MECHATROLINK-III communication cable connectors on both ends and ring core (20m)	456 EUR
JEPMC-W6013-30-E	CN6 A/B MECHATROLINK-III communication cable connectors on both ends and ring core (30m)	627 EUR
JEPMC-W6013-50-E	CN6 A/B MECHATROLINK-III communication cable connectors on both ends and ring core (50m)	978 EUR
JEPMC-W6014-A5-E	CN6 A/B MECHATROLINK-III communication cable with loose wire at one end (0,5m)	38 EUR
JEPMC-W6014-01-E	CN6 A/B MECHATROLINK-III communication cable with loose wire at one end (1m)	45 EUR
JEPMC-W6014-03-E	CN6 A/B MECHATROLINK-III communication cable with loose wire at one end (3m)	87 EUR



JEPMC-W6014-05-E	CN6 A/B MECHATROLINK-III communication cable with loose wire at one end (5m)	125 EUR
JEPMC-W6014-10-E	CN6 A/B MECHATROLINK-III communication cable with loose wire at one end (10m)	214 EUR
JEPMC-W6014-30-E	CN6 A/B MECHATROLINK-III communication cable with loose wire at one end (30m)	580 EUR
JEPMC-W6014-50-E	CN6 A/B MECHATROLINK-III communication cable with loose wire at one end (50m)	931 EUR
JZSP-CM3RRM0-00P2-E	MECHATROLINK-III communication cable with RJ45 connectors on both ends (0,2m)	81 EUR
JZSP-CM3RRM0-00P5-E	MECHATROLINK-III communication cable with RJ45 connectors on both ends (0,5m)	84 EUR
JZSP-CM3RRM0-01-E	MECHATROLINK-III communication cable with RJ45 connectors on both ends (1m)	91 EUR
JZSP-CM3RRM0-03-E	MECHATROLINK-III communication cable with RJ45 connectors on both ends (3m)	112 EUR
JZSP-CM3RRM0-05-E	MECHATROLINK-III communication cable with RJ45 connectors on both ends (5m)	129 EUR
JZSP-CM3RRM0-10-E	MECHATROLINK-III communication cable with RJ45 connectors on both ends (10m)	183 EUR
JZSP-CM3RRM0-20-E	MECHATROLINK-III communication cable with RJ45 connectors on both ends (20m)	302 EUR
JZSP-CM3RRM0-30-E	MECHATROLINK-III communication cable with RJ45 connectors on both ends (30m)	401 EUR
JZSP-CM3RMM0-00P2-E	MECHATROLINK-III communication cable with RJ45/IMI connectors (0,2m)	81 EUR
JZSP-CM3RMM0-00P5-E	MECHATROLINK-III communication cable with RJ45/IMI connectors (0,5m)	84 EUR
JZSP-CM3RMM0-01-E	MECHATROLINK-III communication cable with RJ45/IMI connectors (1m)	88 EUR
JZSP-CM3RMM0-03-E	MECHATROLINK-III communication cable with RJ45/IMI connectors (3m)	109 EUR
JZSP-CM3RMM0-05-E	MECHATROLINK-III communication cable with RJ45/IMI connectors (5m)	129 EUR
JZSP-CM3RMM0-10-E	MECHATROLINK-III communication cable with RJ45/IMI connectors (10m)	179 EUR
JZSP-CM3RMM0-20-E	MECHATROLINK-III communication cable with RJ45/IMI connectors (20m)	288 EUR
JZSP-CM3RMM0-30-E	MECHATROLINK-III communication cable with RJ45/IMI connectors (30m)	386 EUR
JZSP-CVS06-02-E	CN7 connection cable for PC 2.5m	113 EUR
JZSP-CVH03-03-E-G5	CN8 Cable with connector for safety functions 3m	60 EUR
2013595-1	CN8 Connector kit for Safety	18 EUR
JZSP-CLP70-03-E-G5	CN31 Cable for connecting serial converter for Fully-closed for Sigma-7 (3m)	161 EUR
JZSP-CLP70-05-E-G5	CN31 Cable for connecting serial converter for Fully-closed for Sigma-7 (5m)	200 EUR
JZSP-CLP70-10-E-G5	CN31 Cable for connecting serial converter for Fully-closed for Sigma-7 (10m)	295 EUR
JZSP-CLP70-15-E-G5	CN31 Cable for connecting serial converter for Fully-closed for Sigma-7 (15m)	389 EUR
KLBLUE 4-13.5 SET	Shielding clamp SET for motor cable 4-13.5mm <sup>2</sup> for Servopacks: Sigma 7 200V up to 750W, Sigma-5 200V up to 750W	10 EUR
KLBLUE 4-13.5 SC	Shielding clamp for motor cable 4-13.5mm <sup>2</sup> for Servopacks: Sigma 7 400V up to 3.0 kW, Sigma 7 200V 1.5 kW 1ph, Sigma 5 200V 1.5 kW 1ph	7 EUR
EUOP-M92019	Sigma-7 200V connector kit for servopacks SGD7S-R70Axxx to SGD7S-2R8Axxx, Including: Main power connector, Motor power connector, Safety jumper, Lever tool & cable bridges	28 EUR
EUOP-M92020	Sigma-7 200V connector kit for servopack SGD7S-5R5Axxx, Including: Main power connector, Motor power connector, Safety jumper, Lever tool & cable bridges	32 EUR
JUSP-RA04-E	Resistor for Sigma-7 for SGD7S-470A Type 200V Servo Amplifier	432 EUR
JUSP-RA05-E	Resistor for Sigma-7 for SGD7S-550A, 590A, 780A Type 200V Servo Amplifier	692 EUR
JZDP-H003-XXX	Serial Converter for external Encoder Heidenhain, 8 bit resolution	521 EUR
JZDP-H005-XXX	Serial Converter for external Encoder Renishaw, 8 bit resolution	521 EUR
SGDV-OSA01A	Advanced Safety Option Card	179 EUR
SGDV-OZA01A	Mounting Kit for Sigma-7 Option Cards	46 EUR
SGDV-OFA01A	Fully-closed Loop Option Card Sigma-7	81 EUR

#### Filters for SGD7S Servopacks (Combi Filters including control power)

Ürün Kodu	Açıklama	Liste Fiyatı
FESS-B005A	Noise Filter for Sigma-7 1ph for SGD7S-R70A - 2R8A Type 230V Servo Amplifier	91 EUR
FESS-B009A	Noise Filter for Sigma-7 1ph for SGD7S-5R5A & 7R6A Type 230V Servo Amplifier	119 EUR
FESS-B016A	Noise Filter for Sigma-7 1ph for SGD7S-120A Type 230V Servo Amplifier	179 EUR

These Filters are compatible with Sigma V

#### Reactors for SGD7S Servopacks

Ürün Kodu	Açıklama	Liste Fiyatı
X5060	DC Reactors for Sigma-7 for SGD7S-120A Type 230V Servo Amplifier	238 EUR
X5061	DC Reactors for Sigma-7 for SGD7S-R70A - 7R6A Type 230V Servo Amplifier	228 EUR



## Servopack Sigma 7 - Mechatrolink III Type Double Axis

- @ 200 VAC to 240 VAC, -15% to +10%, 50 Hz/60 Hz
- @ Single phase possible for 0.2, 0.4 & 0.75 kW
- @ Power: 0.20 kW - 1.00 kW
- @ Speed frequency response: 3.1kHz
- @ Ripple compensation, vibration suppression
- @ One amplifier for linear and rotary motors
- @ UL-, CE-conform, RoHS-conform
- @ Safety function: STO

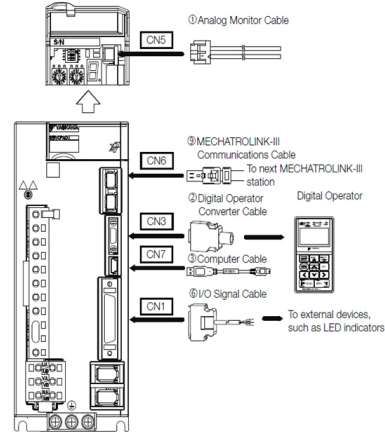

### Mechatrolink III Double Axis SERVOPACK SGD7W-####20

Ürün Kodu	Açıklama	Liste Fiyatı
SGD7W-1R6A20A700	Sigma 7 Servo Amplifier 2x 0.2kW 1/3ph 230V Mechatrolink III, Double Axis with STO	1.581 EUR
SGD7W-2R8A20A700	Sigma 7 Servo Amplifier 2x 0.4 kW 1/3ph 230V Mechatrolink III, Double Axis with STO	1.680 EUR
SGD7W-5R5A20A700	Sigma 7 Servo Amplifier 2x 0.75kW 1/3ph 230V Mechatrolink III, Double Axis with STO	1.972 EUR
SGD7W-7R6A20A700	Sigma 7 Servo Amplifier 2x 1.00kW 3ph 230V Mechatrolink III, Double Axis with STO	Sorunuz

### Mechatrolink III SERVOPACK accesories SGD7W-####20

Ürün Kodu	Açıklama	Liste Fiyatı
JUSP-TA36P-E	CN1 I/O Connector with Terminal Block 0.5m	222 EUR
JUSP-TA36P-1-E	CN1 I/O Connector with Terminal Block 1m	317 EUR
JUSP-TA36P-2-E	CN1 I/O Connector with Terminal Block 2m	375 EUR
JZSP-CSI03-1-E	CN1 I/O connector with flying lead cable 1m	112 EUR
JZSP-CSI03-2-E	CN1 I/O connector with flying lead cable 2m	141 EUR
JZSP-CSI03-3-E	CN1 I/O connector with flying lead cable 3m	165 EUR
JUSP-OP05A-1-E	CN3 Digital Operator with connection cable 1m	432 EUR
JZSP-CVS05-A3-E	CN3 Digital Operator convertor cable with Connectors at both ends 0.3m	161 EUR
JZSP-CVS07-A3-E	CN3 Digital Operator convertor cable with lock screws 0.3m	215 EUR
JZSP-CA01-E	CN5 Cable for Analog Monitor 1m	20 EUR
JEPMC-W6012-A2-E	CN6 A/B MECHATROLINK-III communication cable connectors on both ends (0,2m)	53 EUR
JEPMC-W6012-A5-E	CN6 A/B MECHATROLINK-III communication cable connectors on both ends (0,5m)	56 EUR
JEPMC-W6012-01-E	CN6 A/B MECHATROLINK-III communication cable connectors on both ends (1m)	67 EUR
JEPMC-W6012-02-E	CN6 A/B MECHATROLINK-III communication cable connectors on both ends (2m)	87 EUR
JEPMC-W6012-03-E	CN6 A/B MECHATROLINK-III communication cable connectors on both ends (3m)	105 EUR
JEPMC-W6012-05-E	CN6 A/B MECHATROLINK-III communication cable connectors on both ends (5m)	149 EUR
JEPMC-W6012-10-E	CN6 A/B MECHATROLINK-III communication cable connectors on both ends (10m)	232 EUR
JEPMC-W6012-20-E	CN6 A/B MECHATROLINK-III communication cable connectors on both ends (20m)	414 EUR
JEPMC-W6012-30-E	CN6 A/B MECHATROLINK-III communication cable connectors on both ends (30m)	593 EUR
JEPMC-W6012-50-E	CN6 A/B MECHATROLINK-III communication cable connectors on both ends (50m)	955 EUR
JEPMC-W6013-10-E	CN6 A/B MECHATROLINK-III communication cable connectors on both ends and ring core (10m)	283 EUR
JEPMC-W6013-20-E	CN6 A/B MECHATROLINK-III communication cable connectors on both ends and ring core (20m)	456 EUR
JEPMC-W6013-30-E	CN6 A/B MECHATROLINK-III communication cable connectors on both ends and ring core (30m)	627 EUR
JEPMC-W6013-50-E	CN6 A/B MECHATROLINK-III communication cable connectors on both ends and ring core (50m)	978 EUR
JEPMC-W6014-A5-E	CN6 A/B MECHATROLINK-III communication cable with loose wire at one end (0,5m)	38 EUR
JEPMC-W6014-01-E	CN6 A/B MECHATROLINK-III communication cable with loose wire at one end (1m)	45 EUR
JEPMC-W6014-03-E	CN6 A/B MECHATROLINK-III communication cable with loose wire at one end (3m)	87 EUR
JEPMC-W6014-05-E	CN6 A/B MECHATROLINK-III communication cable with loose wire at one end (5m)	125 EUR
JEPMC-W6014-10-E	CN6 A/B MECHATROLINK-III communication cable with loose wire at one end (10m)	214 EUR
JEPMC-W6014-30-E	CN6 A/B MECHATROLINK-III communication cable with loose wire at one end (30m)	580 EUR
JEPMC-W6014-50-E	CN6 A/B MECHATROLINK-III communication cable with loose wire at one end (50m)	931 EUR
JZSP-CM3RRM0-00P2-E	MECHATROLINK-III communication cable with RJ45 connectors on both ends (0,2m)	81 EUR
JZSP-CM3RRM0-00P5-E	MECHATROLINK-III communication cable with RJ45 connectors on both ends (0,5m)	84 EUR
JZSP-CM3RRM0-01-E	MECHATROLINK-III communication cable with RJ45 connectors on both ends (1m)	91 EUR
JZSP-CM3RRM0-03-E	MECHATROLINK-III communication cable with RJ45 connectors on both ends (3m)	112 EUR
JZSP-CM3RRM0-05-E	MECHATROLINK-III communication cable with RJ45 connectors on both ends (5m)	129 EUR
JZSP-CM3RRM0-10-E	MECHATROLINK-III communication cable with RJ45 connectors on both ends (10m)	183 EUR
JZSP-CM3RR00-20-E	MECHATROLINK-III communication cable with RJ45 connectors on both ends (20m)	302 EUR
JZSP-CM3RR00-30-E	MECHATROLINK-III communication cable with RJ45 connectors on both ends (30m)	401 EUR
JZSP-CM3RMM0-00P2-E	MECHATROLINK-III communication cable with RJ45/IMI connectors (0,2m)	81 EUR
JZSP-CM3RMM0-00P5-E	MECHATROLINK-III communication cable with RJ45/IMI connectors (0,5m)	84 EUR

JZSP-CM3RMM0-01-E	MECHATROLINK-III communication cable with RJ45/IMI connectors (1m)	88 EUR
JZSP-CM3RMM0-03-E	MECHATROLINK-III communication cable with RJ45/IMI connectors (3m)	109 EUR
JZSP-CM3RMM0-05-E	MECHATROLINK-III communication cable with RJ45/IMI connectors (5m)	129 EUR
JZSP-CM3RMM0-10-E	MECHATROLINK-III communication cable with RJ45/IMI connectors (10m)	179 EUR
JZSP-CM3RM00-20-E	MECHATROLINK-III communication cable with RJ45/IMI connectors (20m)	288 EUR
JZSP-CM3RM00-30-E	MECHATROLINK-III communication cable with RJ45/IMI connectors (30m)	386 EUR
JZSP-CVS06-02-E	CN7 connection cable for PC 2.5m	113 EUR
DP9420007-E	CN11 I/O Connector kit	42 EUR
KLBUE 4-13.5 SET	Shielding clamp SET for motor cable 4-13.5mm <sup>2</sup> for Servopacks: Sigma 7 200V up to 750W, Sigma-5 200V up to 750W	10 EUR
KLBUE 4-13.5 SC	Shielding clamp for motor cable 4-13.5mm <sup>2</sup> for Servopacks: Sigma 7 400V up to 3.0 kW, Sigma 7 200V 1.5 kW 1ph, Sigma 5 200V 1.5 kW 1ph	7 EUR
JZDP-H003-XXX	Serial Converter for external Encoder Heidenhain, 8 bit resolution	521 EUR
JZDP-H005-XXX	Serial Converter for external Encoder Renishaw, 8 bit resolution	521 EUR
JZDP-J003-XXX	Serial Converter for external Encoder Heidenhain, 12 bit resolution	573 EUR
JZDP-J005-XXX	Serial Converter for external Encoder Renishaw, 12 bit resolution	573 EUR

## Reactors for SGD7W Servopacks

Ürün Kodu	Açıklama	Liste Fiyatı
X5061	DC Reactors for Sigma-7 for SGD7W-R70A - 7R6A Type 230V Servo Amplifier	228 EUR



## Servopack Sigma 7 - EtherCAT embedded Type

- @ 200 VAC to 240 VAC, -15% to +10%, 50 Hz/60 Hz
- @ Single phase possible for 0.05-0.75 & 1.50kW
- @ Power: 0.05kW - 1.50kW
- @ Speed frequency response: 3.1kHz
- @ Ripple compensation, vibration suppression
- @ One amplifier for linear and rotary motors
- @ UL-, CE-conform, RoHS-conform
- @ Safety SIL3 PLe (Category 3) for STO

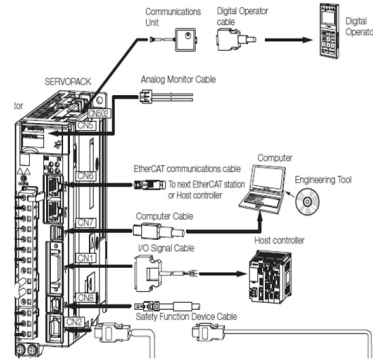

### EtherCAT embedded SERVOPACK SGD7S-####A0

Ürün Kodu	Açıklama	Liste Fiyatı
SGD7S-R70AA0A	Sigma 7 Servo Amplifier 0.05kW 1/3ph 230V EtherCAT embedded	936 EUR
SGD7S-R90AA0A	Sigma 7 Servo Amplifier 0.10kW 1/3ph 230V EtherCAT embedded	936 EUR
SGD7S-1R6AA0A	Sigma 7 Servo Amplifier 0.20kW 1/3ph 230V EtherCAT embedded	981 EUR
SGD7S-2R8AA0A	Sigma 7 Servo Amplifier 0.40kW 1/3ph 230V EtherCAT embedded	1.032 EUR
SGD7S-5R5AA0A	Sigma 7 Servo Amplifier 0.75kW 1/3ph 230V EtherCAT embedded	1.247 EUR
SGD7S-120AA0A008	Sigma 7 Servo Amplifier 1.50kW 1ph 230V EtherCAT embedded	1.579 EUR

### EtherCAT embedded SERVOPACK accessories SGD7S-####A0

Ürün Kodu	Açıklama	Liste Fiyatı
JUSP-TA26P-E	CN1 I/O Connector with Terminal Block 0.5m	425 EUR
JUSP-TA26P-1-E	CN1 I/O Connector with Terminal Block 1m	452 EUR
JUSP-TA26P-2-E	CN1 I/O Connector with Terminal Block 2m	474 EUR
SBK-U-VBA-01	Terminal block for I/O Signals, 26 Pins, length 1 m	229 EUR
JZSP-CSI02-1-E	CN1 I/O connector with flying lead cable 1m	99 EUR
JZSP-CSI02-2-E	CN1 I/O connector with flying lead cable 2m	121 EUR
JZSP-CSI02-3-E	CN1 I/O connector with flying lead cable 3m	151 EUR
JZSP-CSI9-2-E	CN1 connector kit for I/O signals	42 EUR
JUSP-OP05A-1-E	CN3 Digital Operator with connection cable 1m	432 EUR
JZSP-CVS05-A3-E	CN3 Digital Operator convertor cable with Connectors at both ends 0.3m	161 EUR
JZSP-CVS07-A3-E	CN3 Digital Operator convertor cable with lock screws 0.3m	215 EUR
JZSP-CA01-E	CN5 Cable for Analog Monitor 1m	20 EUR
JZSP-CVS06-02-E	CN7 connection cable for PC 2.5m	113 EUR
JZSP-CVH03-03-E-G5	CN8 Cable with connector for safety functions 3m	60 EUR
2013595-1	CN8 Connector kit for Safety	18 EUR
JZSP-CLP70-03-E-G5	CN31 Cable for connecting serial converter for Fully-closed for Sigma-7 (3m)	161 EUR
JZSP-CLP70-05-E-G5	CN31 Cable for connecting serial converter for Fully-closed for Sigma-7 (5m)	200 EUR
JZSP-CLP70-10-E-G5	CN31 Cable for connecting serial converter for Fully-closed for Sigma-7 (10m)	295 EUR
JZSP-CLP70-15-E-G5	CN31 Cable for connecting serial converter for Fully-closed for Sigma-7 (15m)	389 EUR
KLBLUE 4-13.5 SET	Shielding clamp SET for motor cable 4-13.5mm <sup>2</sup> for Servopacks: Sigma 7 200V up to 750W, Sigma-5 200V up to 750W	10 EUR
KLBLUE 4-13.5 SC	Shielding clamp for motor cable 4-13.5mm <sup>2</sup> for Servopacks: Sigma 7 400V up to 3.0 kW, Sigma 7 200V 1.5 kW 1ph, Sigma 5 200V 1.5 kW 1ph	7 EUR
EUOP-M92019	Sigma-7 200V connector kit for servopacks SGD7S-R70Axxx to SGD7S-2R8Axxx, Including: Main power connector, Motor power connector, Safety jumper, Lever tool & cable bridges	28 EUR
EUOP-M92020	Sigma-7 200V connector kit for servopack SGD7S-5R5Axxx, Including: Main power connector, Motor power connector, Safety jumper, Lever tool & cable bridges	32 EUR
JUSP-RA04-E	Resistor for Sigma-7 for SGD7S-470A Type 200V Servo Amplifier	432 EUR
JUSP-RA05-E	Resistor for Sigma-7 for SGD7S-550A, 590A, 780A Type 200V Servo Amplifier	692 EUR
JZDP-H003-XXX	Serial Converter for external Encoder Heidenhain, 8 bit resolution	521 EUR
JZDP-H005-XXX	Serial Converter for external Encoder Renishaw, 8 bit resolution	521 EUR
JZDP-J003-XXX	Serial Converter for external Encoder Heidenhain, 12 bit resolution	573 EUR
JZDP-J005-XXX	Serial Converter for external Encoder Renishaw, 12 bit resolution	573 EUR
SGDV-OSA01A	Advanced Safety Option Card	179 EUR
SGDV-OZA01A	Mounting Kit for Sigma-7 Option Cards	46 EUR
SGDV-OFA01A	Fully-closed Loop Option Card Sigma-7	81 EUR

## Filters for SGD7S Servopacks (Combi Filters including control power)

Ürün Kodu	Açıklama	Liste Fiyatı
FESS-B005A	Noise Filter for Sigma-7 1ph for SGD7S-R70A - 2R8A Type 230V Servo Amplifier	91 EUR
FESS-B009A	Noise Filter for Sigma-7 1ph for SGD7S-5R5A & 7R6A Type 230V Servo Amplifier	119 EUR
FESS-B016A	Noise Filter for Sigma-7 1ph for SGD7S-120A Type 230V Servo Amplifier	179 EUR

These Filters are compatible with Sigma V

## Reactors for SGD7S Servopacks

Ürün Kodu	Açıklama	Liste Fiyatı
X5060	DC Reactors for Sigma-7 for SGD7S-120A Type 230V Servo Amplifier	238 EUR
X5061	DC Reactors for Sigma-7 for SGD7S-R70A - 7R6A Type 230V Servo Amplifier	228 EUR



## Medium Inertia Servomotor Sigma 7 Series (SGM7J)

- @ 0.05 - 0.75kW
- @ 230V
- @ 3.000 rpm rated speed, 6.000 rpm max. speed
- @ 0.159-2.39 Nm rated torque
- @ Optional 24VDC holding brake
- @ Special Oil Seal optional
- @ CE certified, cULus-listed and RoHS conform
- @ IP54 (IP67)

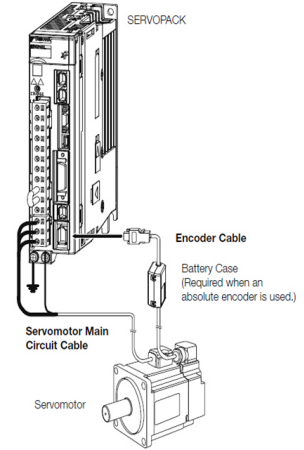

### SGM7J Medium Inertia Servo motor with 24-bit Incremental Encoder

Ürün Kodu	Açıklama	Liste Fiyatı
SGM7J-A5AFA61	AC Motor 230V 3ph,0.05kW (0.159Nm rated,0.557Nm peak) 24bit IncEnc	537 EUR
SGM7J-01AFA61	AC Motor 230V 3ph,0.10kW (0.318Nm rated,1.11Nm peak) 24bit IncEnc	559 EUR
SGM7J-02AFA61	AC Motor 230V 3ph,0.20kW (0.637Nm rated,2.23Nm peak) 24bit IncEnc	644 EUR
SGM7J-04AFA61	AC Motor 230V 3ph,0.40kW (1.27Nm rated, 4.46Nm peak) 24bit IncEnc	771 EUR
SGM7J-06AFA61	AC Motor 230V 3ph,0.60kW (1.91Nm rated, 6.69Nm peak) 24bit IncEnc	914 EUR
SGM7J-08AFA61	AC Motor 230V 3ph,0.75kW (2.39Nm rated,8.36Nm peak) 24bit IncEnc	813 EUR

### SGM7J Medium Inertia Servo motor with 24-bit Incremental Encoder + Brake

Ürün Kodu	Açıklama	Liste Fiyatı
SGM7J-A5AFA6C	AC Motor 230V 3ph,0.05kW (0.159Nm rated,0.557Nm peak) 24bit IncEnc+Brake	838 EUR
SGM7J-01AFA6C	AC Motor 230V 3ph,0.10kW (0.318Nm rated,1.11Nm peak) 24bit IncEnc+Brake	834 EUR
SGM7J-02AFA6C	AC Motor 230V 3ph,0.20kW (0.637Nm rated,2.23Nm peak) 24bit IncEnc+Brake	931 EUR
SGM7J-04AFA6C	AC Motor 230V 3ph,0.40kW (1.27Nm rated, 4.46Nm peak) 24bit IncEnc+Brake	1.059 EUR
SGM7J-06AFA6C	AC Motor 230V 3ph,0.60kW (1.91Nm rated, 6.69Nm peak) 24bit IncEnc+Brake	1.255 EUR
SGM7J-08AFA6C	AC Motor 230V 3ph,0.75kW (2.39Nm rated,8.36Nm peak) 24bit IncEnc+Brake	1.342 EUR

### SGM7J Medium Inertia Servo motor with 24-bit Absolut Encoder

Ürün Kodu	Açıklama	Liste Fiyatı
SGM7J-A5A7A61	AC Motor 230V 3ph,0.05kW (0.159Nm rated,0.557Nm peak) 24bit AbsEnc	712 EUR
SGM7J-01A7A61	AC Motor 230V 3ph,0.10kW (0.318Nm rated,1.11Nm peak) 24bit AbsEnc	736 EUR
SGM7J-02A7A61	AC Motor 230V 3ph,0.20kW (0.637Nm rated,2.23Nm peak) 24bit AbsEnc	836 EUR
SGM7J-04A7A61	AC Motor 230V 3ph,0.40kW (1.27Nm rated, 4.46Nm peak) 24bit AbsEnc	949 EUR
SGM7J-06A7A61	AC Motor 230V 3ph,0.60kW (1.91Nm rated, 6.69Nm peak) 24bit AbsEnc	1.116 EUR
SGM7J-08A7A61	AC Motor 230V 3ph,0.75kW (2.39Nm rated,8.36Nm peak) 24bit AbsEnc	1.154 EUR

### SGM7J Medium Inertia Servo motor with 24-bit Absolut Encoder + Brake

Ürün Kodu	Açıklama	Liste Fiyatı
SGM7J-A5A7A6C	AC Motor 230V 3ph,0.05kW (0.159Nm rated,0.557Nm peak) 24bit AbsEnc+Brake	987 EUR
SGM7J-01A7A6C	AC Motor 230V 3ph,0.10kW (0.318Nm rated,1.11Nm peak) 24bit AbsEnc+Brake	1.024 EUR
SGM7J-02A7A6C	AC Motor 230V 3ph,0.20kW (0.637Nm rated,2.23Nm peak) 24bit AbsEnc+Brake	1.158 EUR
SGM7J-04A7A6C	AC Motor 230V 3ph,0.40kW (1.27Nm rated, 4.46Nm peak) 24bit AbsEnc+Brake	1.265 EUR
SGM7J-06A7A6C	AC Motor 230V 3ph,0.60kW (1.91Nm rated, 6.69Nm peak) 24bit AbsEnc+Brake	1.465 EUR
SGM7J-08A7A6C	AC Motor 230V 3ph,0.75kW (2.39Nm rated,8.36Nm peak) 24bit AbsEnc+Brake	1.536 EUR



## Low Inertia Servomotor Sigma 7 Series (SGM7A)

- @ 0.05 - 7.00kW
- @ 230V
- @ 3.000 rpm rated speed, 6.000 rpm max. speed
- @ 0.159-22.3 Nm rated torque
- @ Optional 24VDC holding brake
- @ Special Oil Seal optional
- @ CE certified, cULus-listed and RoHS conform
- @ IP54 (IP67)

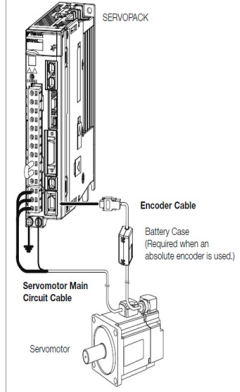

### SGM7A Low Inertia Servo motor with 24-bit Incremental Encoder

Ürün Kodu	Açıklama	Liste Fiyatı
SGM7A-A5AFA61	AC Motor 230V 3ph, 0.05kW (0.159Nm rated, 0.557Nm peak) 24bit IncEnc	526 EUR
SGM7A-01AFA61	AC Motor 230V 3ph, 0.10kW (0.318Nm rated, 1.11Nm peak) 24bit IncEnc	601 EUR
SGM7A-C2AFA61	AC Motor 230V 3ph, 0.15kW (0.477Nm rated, 1.67Nm peak) 24bit IncEnc	650 EUR
SGM7A-02AFA61	AC Motor 230V 3ph, 0.20kW (0.637Nm rated, 2.23Nm peak) 24bit IncEnc	709 EUR
SGM7A-04AFA61	AC Motor 230V 3ph, 0.40kW (1.27Nm rated, 4.46Nm peak) 24bit IncEnc	821 EUR
SGM7A-06AFA61	AC Motor 230V 3ph, 0.60kW (1.91Nm rated, 6.69Nm peak) 24bit IncEnc	921 EUR
SGM7A-08AFA61	AC Motor 230V 3ph, 0.75kW (2.39Nm rated, 8.36Nm peak) 24bit IncEnc	1.021 EUR
SGM7A-10AFA61	AC Motor 230V 3ph, 1.00kW (3.18Nm rated, 11.1Nm peak) 24bit IncEnc	1.053 EUR
SGM7A-15AFA61	AC Motor 230V 3ph, 1.50kW (4.90Nm rated, 14.7Nm peak) 24bit IncEnc	1.313 EUR

Power sizes above 1,5kW in 3ph. 200V are existing and can be quoted on request only!

### SGM7A Low Inertia Servo motor with 24-bit Incremental Encoder+Brake

Ürün Kodu	Açıklama	Liste Fiyatı
SGM7A-A5AFA6C	AC Motor 230V 3ph, 0.05kW (0.159Nm rated, 0.557Nm peak) 24bit IncEnc+Brake	858 EUR
SGM7A-01AFA6C	AC Motor 230V 3ph, 0.10kW (0.318Nm rated, 1.11Nm peak) 24bit IncEnc+Brake	924 EUR
SGM7A-C2AFA6C	AC Motor 230V 3ph, 0.15kW (0.477Nm rated, 1.67Nm peak) 24bit IncEnc+Brake	953 EUR
SGM7A-02AFA6C	AC Motor 230V 3ph, 0.20kW (0.637Nm rated, 2.23Nm peak) 24bit IncEnc+Brake	1.024 EUR
SGM7A-04AFA6C	AC Motor 230V 3ph, 0.40kW (1.27Nm rated, 4.46Nm peak) 24bit IncEnc+Brake	1.140 EUR
SGM7A-06AFA6C	AC Motor 230V 3ph, 0.60kW (1.91Nm rated, 6.69Nm peak) 24bit IncEnc+Brake	1.305 EUR
SGM7A-08AFA6C	AC Motor 230V 3ph, 0.75kW (2.39Nm rated, 8.36Nm peak) 24bit IncEnc+Brake	1.405 EUR
SGM7A-10AFA6C	AC Motor 230V 3ph, 1.00kW (3.18Nm rated, 11.1Nm peak) 24bit IncEnc+Brake	1.531 EUR
SGM7A-15AFA6C	AC Motor 230V 3ph, 1.50kW (4.90Nm rated, 14.7Nm peak) 24bit IncEnc+Brake	1.787 EUR

Power sizes above 1,5kW in 3ph. 200V are existing and can be quoted on request only!

### SGM7A Low Inertia Servo motor with 24-bit Absolute Encoder

Ürün Kodu	Açıklama	Liste Fiyatı
SGM7A-A5A7A61	AC Motor 230V 3ph, 0.05kW (0.159Nm rated, 0.557Nm peak) 24bit AbsEnc	712 EUR
SGM7A-01A7A61	AC Motor 230V 3ph, 0.10kW (0.318Nm rated, 1.11Nm peak) 24bit AbsEnc	736 EUR
SGM7A-C2A7A61	AC Motor 230V 3ph, 0.15kW (0.477Nm rated, 1.67Nm peak) 24bit AbsEnc	778 EUR
SGM7A-02A7A61	AC Motor 230V 3ph, 0.20kW (0.637Nm rated, 2.23Nm peak) 24bit AbsEnc	836 EUR
SGM7A-04A7A61	AC Motor 230V 3ph, 0.40kW (1.27Nm rated, 4.46Nm peak) 24bit AbsEnc	949 EUR
SGM7A-06A7A61	AC Motor 230V 3ph, 0.60kW (1.91Nm rated, 6.69Nm peak) 24bit AbsEnc	1.049 EUR
SGM7A-08A7A61	AC Motor 230V 3ph, 0.75kW (2.39Nm rated, 8.36Nm peak) 24bit AbsEnc	1.154 EUR
SGM7A-10A7A61	AC Motor 230V 3ph, 1.00kW (3.18Nm rated, 11.1Nm peak) 24bit AbsEnc	1.457 EUR
SGM7A-15A7A61	AC Motor 230V 3ph, 1.50kW (4.90Nm rated, 14.7Nm peak) 24bit AbsEnc	1.485 EUR

Power sizes above 1,5kW in 3ph. 200V are existing and can be quoted on request only!

## SGM7A Low Inertia Servo motor with 24-bit Absolute Encoder+Brake

Ürün Kodu	Açıklama	Liste Fiyatı
SGM7A-A5A7A6C	AC Motor 230V 3ph, 0.05kW (0.159Nm rated, 0.557Nm peak) 24bit AbsEnc+Brake	987 EUR
SGM7A-01A7A6C	AC Motor 230V 3ph, 0.10kW (0.318Nm rated, 1.11Nm peak) 24bit AbsEnc+Brake	1.024 EUR
SGM7A-C2A7A6C	AC Motor 230V 3ph, 0.15kW (0.477Nm rated, 1.67Nm peak) 24bit AbsEnc+Brake	1.087 EUR
SGM7A-02A7A6C	AC Motor 230V 3ph, 0.20kW (0.637Nm rated, 2.23Nm peak) 24bit AbsEnc+Brake	1.158 EUR
SGM7A-04A7A6C	AC Motor 230V 3ph, 0.40kW (1.27Nm rated, 4.46Nm peak) 24bit AbsEnc+Brake	1.265 EUR
SGM7A-06A7A6C	AC Motor 230V 3ph, 0.60kW (1.91Nm rated, 6.69Nm peak) 24bit AbsEnc+Brake	1.429 EUR
SGM7A-08A7A6C	AC Motor 230V 3ph, 0.75kW (2.39Nm rated, 8.36Nm peak) 24bit AbsEnc+Brake	1.536 EUR
SGM7A-10A7A6C	AC Motor 230V 3ph, 1.00kW (3.18Nm rated, 11.1Nm peak) 24bit AbsEnc+Brake	1.673 EUR
SGM7A-15A7A6C	AC Motor 230V 3ph, 1.50kW (4.90Nm rated, 14.7Nm peak) 24bit AbsEnc+Brake	2.101 EUR

Power sizes above 1,5kW in 3ph. 200V are existing and can be quoted on request only!

## Servo Motor Power Cable flexible type 0.05 to 1.50kW SGM7A/7J

Ürün Kodu	Açıklama	Liste Fiyatı
JZSP-CSM21-03-E-G5	Flexible Power cable(3m) for SGM7A/7J (0.05-0.15kW)	105 EUR
JZSP-CSM21-05-E-G5	Flexible Power cable(5m) for SGM7A/7J (0.05-0.15kW)	125 EUR
JZSP-CSM21-10-E-G5	Flexible Power cable(10m) for SGM7A/7J (0.05-0.15kW)	172 EUR
JZSP-CSM21-15-E-G5	Flexible Power cable(15m) for SGM7A/7J (0.05-0.15kW)	220 EUR
JZSP-CSM21-20-E-G5	Flexible Power cable(20m) for SGM7A/7J (0.05-0.15kW)	270 EUR
JZSP-CSM22-03-E-G5	Flexible Power cable(3m) for SGM7A/7J (0.20-0.60kW)	105 EUR
JZSP-CSM22-05-E-G5	Flexible Power cable(5m) for SGM7A/7J (0.20-0.60kW)	125 EUR
JZSP-CSM22-10-E-G5	Flexible Power cable(10m) for SGM7A/7J (0.20-0.60kW)	172 EUR
JZSP-CSM22-15-E-G5	Flexible Power cable(15m) for SGM7A/7J (0.20-0.60kW)	220 EUR
JZSP-CSM22-20-E-G5	Flexible Power cable(20m) for SGM7A/7J (0.20-0.60kW)	270 EUR
JZSP-CSM22-30-E-G5	Flexible Power cable(30m) for SGM7A/7J (0.20-0.60kW)	324 EUR
JZSP-CSM23-03-E-G5	Flexible Power cable(3m) for SGM7A/7J (0.75-1.00kW)	133 EUR
JZSP-CSM23-05-E-G5	Flexible Power cable(5m) for SGM7A/7J (0.75-1.00kW)	169 EUR
JZSP-CSM23-10-E-G5	Flexible Power cable(10m) for SGM7A/7J (0.75-1.00kW)	252 EUR
JZSP-CSM23-15-E-G5	Flexible Power cable(15m) for SGM7A/7J (0.75-1.00kW)	339 EUR
JZSP-CSM23-20-E-G5	Flexible Power cable(20m) for SGM7A/7J (0.75-1.00kW)	428 EUR
JZSP-CSM23-30-E-G5	Flexible Power cable(30m) for SGM7A/7J (0.75-1.00kW)	601 EUR
JZSP-CVMCA12-03-E-G5	Flexible Power cable(3m) for SGM7A (1.50kW)	236 EUR
JZSP-CVMCA12-05-E-G5	Flexible Power cable(5m) for SGM7A (1.50kW)	274 EUR
JZSP-CVMCA12-10-E-G5	Flexible Power cable(10m) for SGM7A (1.50kW)	361 EUR
JZSP-CVMCA12-15-E-G5	Flexible Power cable(15m) for SGM7A (1.50kW)	452 EUR
JZSP-CVMCA12-20-E-G5	Flexible Power cable(20m) for SGM7A (1.50kW)	544 EUR

## Servo Motor Power + Brake Cable flexible type 0.05 to 1.00kW SGM7A/7J

Ürün Kodu	Açıklama	Liste Fiyatı
JZSP-CSM31-03-E-G5	Flexible Power + Brake cable(3m) for SGM7A/7J (0.05-0.15kW)	109 EUR
JZSP-CSM31-05-E-G5	Flexible Power + Brake cable(5m) for SGM7A/7J (0.05-0.15kW)	125 EUR
JZSP-CSM31-10-E-G5	Flexible Power + Brake cable(10m) for SGM7A/7J (0.05-0.15kW)	175 EUR
JZSP-CSM31-15-E-G5	Flexible Power + Brake cable(15m) for SGM7A/7J (0.05-0.15kW)	224 EUR
JZSP-CSM31-20-E-G5	Flexible Power + Brake cable(20m) for SGM7A/7J (0.05-0.15kW)	274 EUR
JZSP-CSM32-03-E-G5	Flexible Power + Brake cable(3m) for SGM7A/7J (0.20-0.60kW)	109 EUR
JZSP-CSM32-05-E-G5	Flexible Power + Brake cable(5m) for SGM7A/7J (0.20-0.60kW)	125 EUR
JZSP-CSM32-10-E-G5	Flexible Power + Brake cable(10m) for SGM7A/7J (0.20-0.60kW)	175 EUR
JZSP-CSM32-15-E-G5	Flexible Power + Brake cable(15m) for SGM7A/7J (0.20-0.60kW)	224 EUR
JZSP-CSM32-20-E-G5	Flexible Power + Brake cable(20m) for SGM7A/7J (0.20-0.60kW)	274 EUR
JZSP-CSM32-25-E-G5	Flexible Power + Brake cable(25m) for SGM7A/7J (0.20-0.60kW)	292 EUR
JZSP-CSM32-30-E-G5	Flexible Power + Brake cable(30m) for SGM7A/7J (0.20-0.60kW)	332 EUR
JZSP-CSM32-35-E-G5	Flexible Power + Brake cable(35m) for SGM7A/7J (0.20-0.60kW)	369 EUR
JZSP-CSM33-03-E-G5	Flexible Power + Brake cable(3m) for SGM7A/7J (0.75-1.00kW)	133 EUR
JZSP-CSM33-05-E-G5	Flexible Power + Brake cable(5m) for SGM7A/7J (0.75-1.00kW)	169 EUR
JZSP-CSM33-10-E-G5	Flexible Power + Brake cable(10m) for SGM7A/7J (0.75-1.00kW)	256 EUR
JZSP-CSM33-15-E-G5	Flexible Power + Brake cable(15m) for SGM7A/7J (0.75-1.00kW)	344 EUR
JZSP-CSM33-20-E-G5	Flexible Power + Brake cable(20m) for SGM7A/7J (0.75-1.00kW)	432 EUR



## Servo Motor Brake Cable Flexible for SGM7A 1.5kW Type

Ürün Kodu	Açıklama	Liste Fiyatı
JZSP-CVB12Y-03-E-G5	Flexible Angled Connector Brake cable(3m) for SGM7A 1.5kW Type	155 EUR
JZSP-CVB12Y-05-E-G5	Flexible Angled Connector Brake cable(5m) for SGM7A 1.5kW Type	175 EUR
JZSP-CVB12Y-10-E-G5	Flexible Angled Connector Brake cable(10m) for SGM7A 1.5kW Type	232 EUR
JZSP-CVB12Y-15-E-G5	Flexible Angled Connector Brake cable(15m) for SGM7A 1.5kW Type	288 EUR
JZSP-CVB12Y-20-E-G5	Flexible Angled Connector Brake cable(20m) for SGM7A 1.5kW Type	339 EUR
JZSP-CVB12Y-30-E-G5	Flexible Angled Connector Brake cable(30m) for SGM7A 1.5kW Type	449 EUR
JZSP-CVB12Y-35-E-G5	Flexible Angled Connector Brake cable(35m) for SGM7A 1.5kW Type	507 EUR

## Servo Motor Connector Kit for SGM7A and SGM7J

Ürün Kodu	Açıklama	Liste Fiyatı
JZSP-CSM9-1-E-G1	Motor connector kit (m) for SGM7J SGM7A (0.05-0.15kW) (Crimping Tool Required)	53 EUR
JZSP-CSM9-2-E-G1	Motor connector kit (m) for SGM7J SGM7A (0.20-0.60kW) (Crimping Tool Required)	56 EUR
JZSP-CSM9-3-E-G1	Motor connector kit (m) for SGM7J SGM7A (0.75-1.00kW) (Crimping Tool Required)	63 EUR

## Incremental Encoder Cable flexible type SGM7A/7J

Ürün Kodu	Açıklama	Liste Fiyatı
JZSP-CSP21-03-E-G5	Flexible Incremental Encoder cable(3m) for SGM7A/7J (0.05-1.00kW)	103 EUR
JZSP-CSP21-05-E-G5	Flexible Incremental Encoder cable(5m) for SGM7A/7J (0.05-1.00kW)	113 EUR
JZSP-CSP21-10-E-G5	Flexible Incremental Encoder cable(10m) for SGM7A/7J (0.05-1.00kW)	155 EUR
JZSP-CSP21-15-E-G5	Flexible Incremental Encoder cable(15m) for SGM7A/7J (0.05-1.00kW)	182 EUR
JZSP-CSP21-20-E-G5	Flexible Incremental Encoder cable(20m) for SGM7A/7J (0.05-1.00kW)	230 EUR
JZSP-CSP21-30-E-G5	Flexible Incremental Encoder cable(30m) for SGM7A/7J (0.05-1.00kW)	319 EUR
JZSP-CSP21-35-E-G5	Flexible Incremental Encoder cable(35m) for SGM7A/7J (0.05-1.00kW)	356 EUR
JZSP-CVP12-03-E-G5	Flexible Incremental Encoder cable(3m) for SGM7A (1.50kW)	169 EUR
JZSP-CVP12-05-E-G5	Flexible Incremental Encoder cable(5m) for SGM7A (1.50kW)	191 EUR
JZSP-CVP12-10-E-G5	Flexible Incremental Encoder cable(10m) for SGM7A (1.50kW)	232 EUR
JZSP-CVP12-15-E-G5	Flexible Incremental Encoder cable(15m) for SGM7A (1.50kW)	278 EUR
JZSP-CVP12-20-E-G5	Flexible Incremental Encoder cable(20m) for SGM7A (1.50kW)	329 EUR
JZSP-CVP12-25-E-G5	Flexible Incremental Encoder cable(25m) for SGM7A (1.50kW)	385 EUR
JZSP-CVP12-30-E-G5	Flexible Incremental Encoder cable(30m) for SGM7A (1.50kW)	425 EUR
JZSP-CVP12-35-E-G5	Flexible Incremental Encoder cable(35m) for SGM7A (1.50kW)	469 EUR

## Incremental Encoder Cable flexible type SGM7A/7J, Installed in load direction

Ürün Kodu	Açıklama	Liste Fiyatı
JZSP-C7PI2D-03-E-G5	Flexible Incremental Encoder cable(3m) for SGM7A/7J (0.05-1.00kW), installed load direction	102 EUR
JZSP-C7PI2D-05-E-G5	Flexible Incremental Encoder cable(5m) for SGM7A/7J (0.05-1.00kW), installed load direction	116 EUR
JZSP-C7PI2D-10-E-G5	Flexible Incremental Encoder cable(10m) for SGM7A/7J (0.05-1.00kW), installed load direction	155 EUR
JZSP-C7PI2D-15-E-G5	Flexible Incremental Encoder cable(15m) for SGM7A/7J (0.05-1.00kW), installed load direction	189 EUR
JZSP-C7PI2D-20-E-G5	Flexible Incremental Encoder cable(20m) for SGM7A/7J (0.05-1.00kW), installed load direction	224 EUR

## Incremental Encoder Cable flexible type SGM7A/7J, Installed away from load direction

Ürün Kodu	Açıklama	Liste Fiyatı
JZSP-C7PI2E-03-E-G5	Flexible Incremental Encoder cable(3m) for SGM7A/7J (0.05-1.00kW), installed opposit load	102 EUR
JZSP-C7PI2E-05-E-G5	Flexible Incremental Encoder cable(5m) for SGM7A/7J (0.05-1.00kW), installed opposit load	116 EUR
JZSP-C7PI2E-10-E-G5	Flexible Incremental Encoder cable(10m) for SGM7A/7J (0.05-1.00kW), installed opposit load	155 EUR
JZSP-C7PI2E-15-E-G5	Flexible Incremental Encoder cable(15m) for SGM7A/7J (0.05-1.00kW), installed opposit load	189 EUR
JZSP-C7PI2E-20-E-G5	Flexible Incremental Encoder cable(20m) for SGM7A/7J (0.05-1.00kW), installed opposit load	224 EUR

## Special Cable for Absolut Encoder

Ürün Kodu	Açıklama	Liste Fiyatı
JZSP-CSP12-E-G5	Extension Encoder cable with Connectors length 0.3m for Abs. Encoder, incl. Battery	100 EUR

## Absolute Encoder Cable flexible type SGM7A/7J

Ürün Kodu	Açıklama	Liste Fiyatı
JZSP-CSP25-03-E-G5	Flexible Absolute Encoder cable(3m) for SGM7A/7J (0.05-1.00kW)	196 EUR
JZSP-CSP25-05-E-G5	Flexible Absolute Encoder cable(5m) for SGM7A/7J (0.05-1.00kW)	220 EUR
JZSP-CSP25-10-E-G5	Flexible Absolute Encoder cable(10m) for SGM7A/7J (0.05-1.00kW)	280 EUR
JZSP-CSP25-15-E-G5	Flexible Absolute Encoder cable(15m) for SGM7A/7J (0.05-1.00kW)	339 EUR
JZSP-CSP25-20-E-G5	Flexible Absolute Encoder cable(20m) for SGM7A/7J (0.05-1.00kW)	400 EUR
JZSP-CSP25-25-E-G5	Flexible Absolute Encoder cable(25m) for SGM7A/7J (0.05-1.00kW)	297 EUR
JZSP-CSP25-30-E-G5	Flexible Absolute Encoder cable(30m) for SGM7A/7J (0.05-1.00kW)	332 EUR
JZSP-CVP27-03-E-G5	Flexible Absolute Encoder cable(3m) for SGM7A (1.50kW)	288 EUR
JZSP-CVP27-05-E-G5	Flexible Absolute Encoder cable(5m) for SGM7A (1.50kW)	312 EUR
JZSP-CVP27-10-E-G5	Flexible Absolute Encoder cable(10m) for SGM7A (1.50kW)	371 EUR
JZSP-CVP27-15-E-G5	Flexible Absolute Encoder cable(15m) for SGM7A (1.50kW)	432 EUR
JZSP-CVP27-20-E-G5	Flexible Absolute Encoder cable(20m) for SGM7A (1.50kW)	492 EUR

## Absolute Encoder Cable flexible type SGM7A/7J, Installed in load direction

Ürün Kodu	Açıklama	Liste Fiyatı
JZSP-C7PA2D-03-E-G5	Flexible Absolute Encoder cable (3m) for SGM7A/7J (0.05-1.0kW) with cable direction to load side	179 EUR
JZSP-C7PA2D-05-E-G5	Flexible Absolute Encoder cable (5m) for SGM7A/7J (0.05-1.0kW) with cable direction to load side	193 EUR
JZSP-C7PA2D-10-E-G5	Flexible Absolute Encoder cable (10m) for SGM7A/7J (0.05-1.0kW) with cable direction to load side	236 EUR
JZSP-C7PA2D-15-E-G5	Flexible Absolute Encoder cable (15m) for SGM7A/7J (0.05-1.0kW) with cable direction to load side	274 EUR
JZSP-C7PA2D-20-E-G5	Flexible Absolute Encoder cable (20m) for SGM7A/7J (0.05-1.0kW) with cable direction to load side	317 EUR

## Absolute Encoder Cable flexible type SGM7A/7J, Installed in direction away from Load

Ürün Kodu	Açıklama	Liste Fiyatı
JZSP-C7PA2E-03-E-G5	Flexible Absolute Encoder cable (3m) for SGM7A/7J (0.05-1.0kW) with cable direction away from load side	179 EUR
JZSP-C7PA2E-05-E-G5	Flexible Absolute Encoder cable (5m) for SGM7A/7J (0.05-1.0kW) with cable direction away from load side	193 EUR
JZSP-C7PA2E-10-E-G5	Flexible Absolute Encoder cable (10m) for SGM7A/7J (0.05-1.0kW) with cable direction away from load side	236 EUR
JZSP-C7PA2E-15-E-G5	Flexible Absolute Encoder cable (15m) for SGM7A/7J (0.05-1.0kW) with cable direction away from load side	274 EUR
JZSP-C7PA2E-20-E-G5	Flexible Absolute Encoder cable (20m) for SGM7A/7J (0.05-1.0kW) with cable direction away from load side	317 EUR

## Encoder Connector Kit for SGM7A and SGM7J

Ürün Kodu	Açıklama	Liste Fiyatı
JZSP-CMP9-1-E-G1	Connector Kit Encoder for CN2 servopack end	20 EUR
JZSP-CSP9-2-E-G1	Encoder-end Connector Kit for motors up to 1.00kW	27 EUR



## Medium Inertia Servomotor Sigma 7 Series (SGM7G)

- @ 0.30 - 1.30kW
- @ 230V
- @ 1.500 rpm rated speed, 3.000 rpm max. speed
- @ 1.96-8.34 Nm rated torque
- @ Optional 24VDC holding brake
- @ Special Oil Seal optional
- @ CE certified, cULus-listed and RoHS conform
- @ IP54 (IP67)

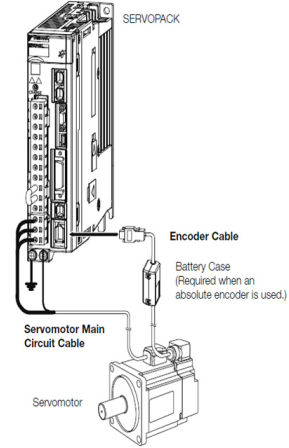

### SGM7G Medium Inertia Servo motor with 24-bit Incremental Encoder

Ürün Kodu	Açıklama	Liste Fiyatı
SGM7G-03AFA61	AC Motor 230V 3ph, 0.30kW (1.96Nm rated, 5.88Nm peak) 24bit IncEnc	839 EUR
SGM7G-05AFA61	AC Motor 230V 3ph, 0.45kW (2.86Nm rated, 8.92Nm peak) 24bit IncEnc	932 EUR
SGM7G-09AFA61	AC Motor 230V 3ph, 0.85kW (5.39Nm rated, 14.2Nm peak) 24bit IncEnc	969 EUR
SGM7G-13AFA61	AC Motor 230V 3ph, 1.30kW (8.34Nm rated, 23.3Nm peak) 24bit IncEnc	1.232 EUR

### SGM7G Medium Inertia Servo motor with 24-bit Incremental Encoder + Brake

Ürün Kodu	Açıklama	Liste Fiyatı
SGM7G-03AFA6C	AC Motor 230V 3ph, 0.30kW (1.96Nm rated, 5.88Nm peak) 24bit IncEnc+Brake	1.146 EUR
SGM7G-05AFA6C	AC Motor 230V 3ph, 0.45kW (2.86Nm rated, 8.92Nm peak) 24bit IncEnc+Brake	1.399 EUR
SGM7G-09AFA6C	AC Motor 230V 3ph, 0.85kW (5.39Nm rated, 14.2Nm peak) 24bit IncEnc+Brake	1.529 EUR
SGM7G-13AFA6C	AC Motor 230V 3ph, 1.30kW (8.34Nm rated, 23.3Nm peak) 24bit IncEnc+Brake	1.776 EUR

### SGM7G Medium Inertia Servo motor with 24-bit Absolut Encoder

Ürün Kodu	Açıklama	Liste Fiyatı
SGM7G-03A7A61	AC Motor 230V 3ph, 0.30kW (1.96Nm rated, 5.88Nm peak) 24bit AbsEnc	997 EUR
SGM7G-05A7A61	AC Motor 230V 3ph, 0.45kW (2.86Nm rated, 8.92Nm peak) 24bit AbsEnc	1.075 EUR
SGM7G-09A7A61	AC Motor 230V 3ph, 0.85kW (5.39Nm rated, 14.2Nm peak) 24bit AbsEnc	1.202 EUR
SGM7G-13A7A61	AC Motor 230V 3ph, 1.30kW (8.34Nm rated, 23.3Nm peak) 24bit AbsEnc	1.397 EUR

### SGM7G Medium Inertia Servo motor with 24-bit Absolut Encoder + Brake

Ürün Kodu	Açıklama	Liste Fiyatı
SGM7G-03A7A6C	AC Motor 230V 3ph, 0.30kW (1.96Nm rated, 5.88Nm peak) 24bit AbsEnc+Brake	1.394 EUR
SGM7G-05A7A6C	AC Motor 230V 3ph, 0.45kW (2.86Nm rated, 8.92Nm peak) 24bit AbsEnc+Brake	1.484 EUR
SGM7G-09A7A6C	AC Motor 230V 3ph, 0.85kW (5.39Nm rated, 14.2Nm peak) 24bit AbsEnc+Brake	1.607 EUR
SGM7G-13A7A6C	AC Motor 230V 3ph, 1.30kW (8.34Nm rated, 23.3Nm peak) 24bit AbsEnc+Brake	1.836 EUR

## Servo Motor Power Cable flexible type 0.30 to 1.30kW SGM7G

Ürün Kodu	Açıklama	Liste Fiyatı
JZSP-CVM21-03-E-G5	Flexible Angled Connector CE05 Power cable(3m) for SGM7G(0.30-0.45Kw)	132 EUR
JZSP-CVM21-05-E-G5	Flexible Angled Connector CE05 Power cable(5m) for SGM7G(0.30-0.45Kw)	166 EUR
JZSP-CVM21-10-E-G5	Flexible Angled Connector CE05 Power cable(10m) for SGM7G(0.30-0.45Kw)	240 EUR
JZSP-CVM21-15-E-G5	Flexible Angled Connector CE05 Power cable(15m) for SGM7G(0.30-0.45Kw)	314 EUR
JZSP-CVM21-20-E-G5	Flexible Angled Connector CE05 Power cable(20m) for SGM7G(0.30-0.45Kw)	384 EUR
JZSP-CVM41-03-E-G5	Flexible Angle CE05 Power + Brake cable(3m) for SGM7G(0.30-0.45Kw)	153 EUR
JZSP-CVM41-05-E-G5	Flexible Angle CE05 Power + Brake cable(5m) for SGM7G(0.30-0.45Kw)	171 EUR
JZSP-CVM41-10-E-G5	Flexible Angle CE05 Power + Brake cable(10m) for SGM7G(0.30-0.45Kw)	197 EUR
JZSP-CVM41-20-E-G5	Flexible Angle CE05 Power + Brake cable(20m) for SGM7G(0.30-0.45Kw)	272 EUR
JZSP-CVMCA12-03-E-G5	Flexible Angled Connector CE05 Power cable(3m) for SGM7G(0.85-1.30Kw)	236 EUR
JZSP-CVMCA12-05-E-G5	Flexible Angled Connector CE05 Power cable(5m) for SGM7G(0.85-1.30Kw)	274 EUR
JZSP-CVMCA12-10-E-G5	Flexible Angled Connector CE05 Power cable(10m) for SGM7G(0.85-1.30Kw)	361 EUR
JZSP-CVMCA12-15-E-G5	Flexible Angled Connector CE05 Power cable(15m) for SGM7G(0.85-1.30Kw)	452 EUR
JZSP-CVMCA12-20-E-G5	Flexible Angled Connector CE05 Power cable(20m) for SGM7G(0.85-1.30Kw)	544 EUR

## Servo Motor Brake Cable Flexible for SGM7G 0.85-1.30kW Type

Ürün Kodu	Açıklama	Liste Fiyatı
JZSP-CVB12Y-03-E-G5	Flexible Angled Connector Brake cable(3m) for SGM7G 0.85-1.30kW Type	155 EUR
JZSP-CVB12Y-05-E-G5	Flexible Angled Connector Brake cable(5m) for SGM7G 0.85-1.30kW Type	175 EUR
JZSP-CVB12Y-10-E-G5	Flexible Angled Connector Brake cable(10m) for SGM7G 0.85-1.30kW Type	232 EUR
JZSP-CVB12Y-15-E-G5	Flexible Angled Connector Brake cable(15m) for SGM7G 0.85-1.30kW Type	288 EUR
JZSP-CVB12Y-20-E-G5	Flexible Angled Connector Brake cable(20m) for SGM7G 0.85-1.30kW Type	339 EUR

## Incremental Encoder Cable flexible type SGM7G

Ürün Kodu	Açıklama	Liste Fiyatı
JZSP-CVP12-03-E-G5	Flexible Incremental Encoder cable(3m) for SGM7G 0.30-1.30kW Type	169 EUR
JZSP-CVP12-05-E-G5	Flexible Incremental Encoder cable(5m) for SGM7G 0.30-1.30kW Type	191 EUR
JZSP-CVP12-10-E-G5	Flexible Incremental Encoder cable(10m) for SGM7G 0.30-1.30kW Type	232 EUR
JZSP-CVP12-15-E-G5	Flexible Incremental Encoder cable(15m) for SGM7G 0.30-1.30kW Type	278 EUR
JZSP-CVP12-20-E-G5	Flexible Incremental Encoder cable(20m) for SGM7G 0.30-1.30kW Type	329 EUR
JZSP-CVP12-25-E-G5	Flexible Incremental Encoder cable(25m) for SGM7G 0.30-1.30kW Type	385 EUR
JZSP-CVP12-30-E-G5	Flexible Incremental Encoder cable(30m) for SGM7G 0.30-1.30kW Type	425 EUR
JZSP-CVP12-35-E-G5	Flexible Incremental Encoder cable(35m) for SGM7G 0.30-1.30kW Type	469 EUR

## Special Cable for Absolute Encoder

Ürün Kodu	Açıklama	Liste Fiyatı
JZSP-CSP12-E-G5	Extension Encoder cable with Connectors length 0.3m for Abs. Encoder, incl. Battery	100 EUR

## Absolute Encoder Cable flexible type SGM7G

Ürün Kodu	Açıklama	Liste Fiyatı
JZSP-CVP27-03-E-G5	Flexible Absolute Encoder cable(3m) for SGM7G 0.30-1.30kW Type	288 EUR
JZSP-CVP27-05-E-G5	Flexible Absolute Encoder cable(5m) for SGM7G 0.30-1.30kW Type	312 EUR
JZSP-CVP27-10-E-G5	Flexible Absolute Encoder cable(10m) for SGM7G 0.30-1.30kW Type	371 EUR
JZSP-CVP27-15-E-G5	Flexible Absolute Encoder cable(15m) for SGM7G 0.30-1.30kW Type	432 EUR
JZSP-CVP27-20-E-G5	Flexible Absolute Encoder cable(20m) for SGM7G 0.30-1.30kW Type	492 EUR

## SGM7G 200V Connectors

Ürün Kodu	Açıklama	Liste Fiyatı
JZSP-CVM9-1-E	Motor End Connector Kit for SGM7G 200V (0.30-0.45kW)	42 EUR
CM10Y-AP2S-M-D-G1	Holding Brake Connector Kit for SGM7G (0.85kW-1.30kW)	112 EUR
JZSP-CMP9-1-E-G1	Connector Kit Encoder CN2	20 EUR
CM10-AP10S-M-D-G1	Encoder Connector Kit L-shaped Plug	54 EUR
JZSP-CVM18-10-E-G4	Motor Connector Kit for SGM7G (0.85-1.30kW)	46 EUR

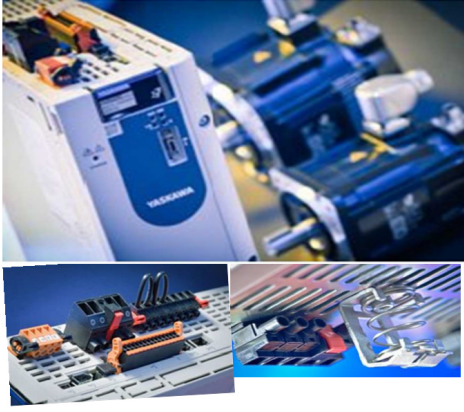

### Servopack Sigma 7 - EtherCAT embedded

- @ 380 VAC to 480 VAC, -15% to +10%, 50 Hz/60 Hz
- @ Power: 0.50kW - 15.00 kW
- @ Speed frequency response: 3.1kHz
- @ Enhanced ripple compensation, vibration suppression
- @ One amplifier for linear and rotary motors
- @ Advanced Safety functions SS1, SS2, SLS
- @ Daisy chain connection for 24V DC, and DC Power input
- @ UL-, CE-conform, RoHS-conform
- @ Safety SIL 3 for STO, Pl-e, CAT 3

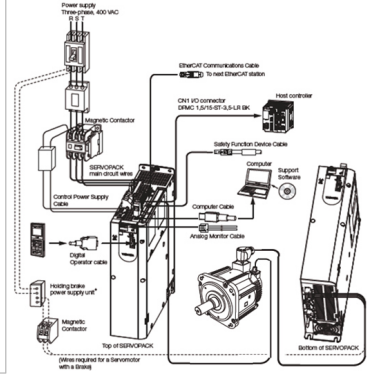

#### EtherCAT embedded SERVOPACK SGD7S-###B000F64

Ürün Kodu	Açıklama	Liste Fiyatı
SGD7S-1R9DA0B000F64	Sigma 7 Servo Amplifier, 0.50kW 3ph, 400V, EtherCAT embedded	1.456 EUR
SGD7S-3R5DA0B000F64	Sigma 7 Servo Amplifier, 1.00kW 3ph, 400V, EtherCAT embedded	1.481 EUR
SGD7S-5R4DA0B000F64	Sigma 7 Servo Amplifier, 1.50kW 3ph, 400V, EtherCAT embedded	1.524 EUR
SGD7S-8R4DA0B000F64	Sigma 7 Servo Amplifier, 2.00kW 3ph, 400V, EtherCAT embedded	1.617 EUR
SGD7S-120DA0B000F64	Sigma 7 Servo Amplifier, 3.00kW 3ph, 400V, EtherCAT embedded	1.965 EUR
SGD7S-170DA0B000F64	Sigma 7 Servo Amplifier, 5.0kW 3ph, 400V, EtherCat embedded	2.734 EUR
SGD7S-210DA0B000F64	Sigma 7 Servo Amplifier, 6.0kW 3ph, 400V, EtherCat embedded	3.814 EUR
SGD7S-260DA0B000F64	Sigma 7 Servo Amplifier, 7.5kW 3ph, 400V, EtherCat embedded	3.882 EUR
SGD7S-280DA0B000F64	Sigma 7 Servo Amplifier, 11.0kW 3ph, 400V, EtherCat embedded	4.135 EUR
SGD7S-370DA0B000F64	Sigma 7 Servo Amplifier, 15.0kW 3ph, 400V, EtherCat embedded	4.224 EUR

#### EtherCAT embedded SERVOPACK with holding brake relay SGD7S-###B026F64

Ürün Kodu	Açıklama	Liste Fiyatı
SGD7S-1R9DA0B026F64	Sigma 7 Servo Amplifier 0.5kW 3ph 400V EtherCat embedded, with holding brake relay	1.502 EUR
SGD7S-3R5DA0B026F64	Sigma 7 Servo Amplifier 1.0kW 3ph 400V EtherCat embedded, with holding brake relay	1.523 EUR
SGD7S-5R4DA0B026F64	Sigma 7 Servo Amplifier 1.5kW 3ph 400V EtherCat embedded, with holding brake relay	1.570 EUR
SGD7S-8R4DA0B026F64	Sigma 7 Servo Amplifier 2.0kW 3ph 400V EtherCat embedded, with holding brake relay	1.662 EUR
SGD7S-120DA0B026F64	Sigma 7 Servo Amplifier 3.0kW 3ph 400V EtherCat embedded, with holding brake relay	2.020 EUR
SGD7S-170DA0B026F64	Sigma 7 Servo Amplifier 5.0kW 3ph 400V EtherCat embedded, with holding brake relay	2.789 EUR
SGD7S-210DA0B026F64	Sigma 7 Servo Amplifier 6.0kW 3ph 400V EtherCat embedded, with holding brake relay	3.886 EUR
SGD7S-260DA0B026F64	Sigma 7 Servo Amplifier 7.5kW 3ph 400V EtherCat embedded, with holding brake relay	3.955 EUR
SGD7S-280DA0B026F64	Sigma 7 Servo Amplifier 11.0kW 3ph 400V EtherCat embedded, with holding brake relay	4.210 EUR
SGD7S-370DA0B026F64	Sigma 7 Servo Amplifier 15.0kW 3ph 400V EtherCat embedded, with holding brake relay	4.300 EUR

#### EtherCAT embedded DUAL AXIS SERVOPACK SGD7W-###DA0B

Ürün Kodu	Açıklama	Liste Fiyatı
SGD7W-2R6DA0B	Sigma 7 Servo Dual Axis Amplifier 2x 0.75kW 3ph 400V EtherCat embedded	2.468 EUR
SGD7W-5R4DA0B	Sigma 7 Servo Dual Axis Amplifier 2x 1.50kW 3ph 400V EtherCat embedded	2.562 EUR

#### EtherCAT embedded DUAL AXIS SERVOPACK with holding brake relay SGD7W-###DA0B026

Ürün Kodu	Açıklama	Liste Fiyatı
SGD7W-2R6DA0B026	Sigma 7 Servo Dual Axis Amplifier 2x 0.75kW 3ph 400V EtherCat embedded, with holding brake relay	2.518 EUR
SGD7W-5R4DA0B026	Sigma 7 Servo Dual Axis Amplifier 2x 1.50kW 3ph 400V EtherCat embedded, with holding brake relay	2.615 EUR

EtherCAT embedded SERVOPACK accesories SGD7S-###DA0

Ürün Kodu	Açıklama	Liste Fiyatı
JUSP-7CN001	I/O connector (CN1), Sigma 7 400V Amplifier	24 EUR
JUSP-7CN101	CN101 Power Input connector, Sigma 7 400V Amplifier SGD7S-1R9D to -170D; SGD7W-xxxD	14 EUR
JUSP-7CN101-1	CN101 Power Input connector, Sigma 7 400V Amplifier SGD7S-210D to -370D	28 EUR
JUSP-7CN102	CN102 Motor power connector, Sigma 7 400V Amplifier SGD7S-1R9D to -170D; SGD7W-xxxD	8 EUR
JUSP-7CN102-1	CN102 Motor power connector, Sigma 7 400V Amplifier SGD7S-210D to -370D	17 EUR
JUSP-7CN103	CN103 Power DC Input connector, Sigma 7 400V Amplifier SGD7S-1R9D to -170D; SGD7W-xxxD	10 EUR
JUSP-7CN103-1	CN103 Power DC Input connector, Sigma 7 400V Amplifier SGD7S-210D to -370D	17 EUR
JUSP-7CN115	CN115 DB Resistor connector for external DB, Sigma 7 400V Amplifier	7 EUR
JUSP-7CN117	CN117 Brake power connector, Sigma 7 400V Amplifier	3 EUR
JUSP-7CN201	CN201 24VDC Input connector, Sigma 7 400V Amplifier	3 EUR
JUSP-OP05A-1-E	CN3 Digital Operator with connection cable 1m	432 EUR
JZSP-CVS05-A3-E	CN3 Digital Operator convertor cable with Connectors at both ends 0.3m	161 EUR
JZSP-CVS07-A3-E	CN3 Digital Operator convertor cable with lock screws 0.3m	215 EUR
JZSP-CA01-E	CN5 Cable for Analog Monitor 1m	20 EUR
JZSP-CVS06-02-E	CN7 connection cable for PC 2.5m	113 EUR
JZSP-CVH03-03-E-G5	CN8 Cable with connector for safety functions 3m	60 EUR
JZSP-CVH05-E	CN8 Jumper Connector	27 EUR
2013595-1	CN8 Connector kit for safety cables	18 EUR
JZSP-CLP70-03-E-G5	CN31 Cable for connecting serial converter for Fully-closed for Sigma-7 (3m)	161 EUR
JZSP-CLP70-05-E-G5	CN31 Cable for connecting serial converter for Fully-closed for Sigma-7 (5m)	200 EUR
JZSP-CLP70-10-E-G5	CN31 Cable for connecting serial converter for Fully-closed for Sigma-7 (10m)	295 EUR
JZSP-CLP70-15-E-G5	CN31 Cable for connecting serial converter for Fully-closed for Sigma-7 (15m)	389 EUR
JZSP-P7R2-8-E	Sigma-7 Mounting rail for option cards	32 EUR
KLBUE 4-13.5 SC	Shielding clamp for motor cable 4-13.5mm <sup>2</sup> for Servopacks: Sigma 7 400V up to 3.0 kW, Sigma 7 200V 1.5 kW 1ph, Sigma 5 200V 1.5 kW 1ph	7 EUR
KLBUE 10-20 SC	Shielding clamp for motor cable 10-20mm for Servopacks: Sigma 7 400V 5.0kW to 7.5kW	17 EUR
KLBUE 15-32 SC	Shielding clamp for motor cable 15-32mm for Servopacks: Sigma 7 400V 11kW and 15kW	21 EUR
JZDP-H003-XXX	Serial Converter for external Encoder Heidenhain, 8 bit resolution	521 EUR
JZDP-H005-XXX	Serial Converter for external Encoder Renishaw, 8 bit resolution	521 EUR
JZDP-J003-XXX	Serial Converter for external Encoder Heidenhain, 12 bit resolution	573 EUR
JZDP-J005-XXX	Serial Converter for external Encoder Renishaw, 12 bit resolution	573 EUR
SGDV-OSA01A000FT900	Advanced Safety Option Card for Sigma 7 400V only	179 EUR
SGDV-OFB01A	Option Feedback Module for EnDat-2.1, EnDat-2.2, Hiperface, Sin/Cos	350 EUR
SGDV-OFB03A	Option Feedback Module for TTL Encoder	400 EUR
SGDV-OFB04A	Option Feedback Module for Resolver encoder	425 EUR
SGDV-OFA01A	Fully-closed Loop Option Card	81 EUR
JZSP-CM3RRM0-00P2-E	MECHATROLINK-III communication cable with RJ45 connectors on both ends (0,2m)	81 EUR
JZSP-CM3RRM0-00P5-E	MECHATROLINK-III communication cable with RJ45 connectors on both ends (0,5m)	84 EUR
JZSP-CM3RRM0-01-E	MECHATROLINK-III communication cable with RJ45 connectors on both ends (1m)	91 EUR
JZSP-CM3RRM0-03-E	MECHATROLINK-III communication cable with RJ45 connectors on both ends (3m)	112 EUR
JZSP-CM3RRM0-05-E	MECHATROLINK-III communication cable with RJ45 connectors on both ends (5m)	129 EUR
JZSP-CM3RRM0-10-E	MECHATROLINK-III communication cable with RJ45 connectors on both ends (10m)	183 EUR
JZSP-CM3RRM0-20-E	MECHATROLINK-III communication cable with RJ45 connectors on both ends (20m)	Sorunuz
JZSP-CM3RRM0-30-E	MECHATROLINK-III communication cable with RJ45 connectors on both ends (30m)	Sorunuz
JZSP-CM3RRM0-40-E	MECHATROLINK-III communication cable with RJ45 connectors on both ends (40m)	Sorunuz
JZSP-CM3RRM0-50-E	MECHATROLINK-III communication cable with RJ45 connectors on both ends (50m)	Sorunuz

Filters for SGD7S Servopacks (Filters for main power only!)

Ürün Kodu	Açıklama	Liste Fiyatı
FESS-4009A	Noise Filter for Sigma-7 for SGD7S-1R9D - 120D Type 400V Servo Amplifier	84 EUR
FESS-4015A	Noise Filter for Sigma-7 for SGD7S-170D Type 400V Servo Amplifier	144 EUR
FESS-4022A	Noise Filter for Sigma-7 for SGD7S-210D - 260D Type 400V Servo Amplifier	Sorunuz
FESS-4044A	Noise Filter for Sigma-7 for SGD7S-280D - 370D Type 400V Servo Amplifier	Sorunuz

DC Reactors for SGD7S Servopacks

Ürün Kodu	Açıklama	Liste Fiyatı
X5074	DC Reactors for Sigma-7 400V Servo Amplifier Type SGD7S-1R9D DC Reactors for Sigma-5 400V Servo Amplifier Type SGDV-1R9D	203 EUR
X5075	DC Reactors for Sigma-7 400V Servo Amplifier Type SGD7S-3R5D - 5R4D, SGD7W-2R9D - 5R4D DC Reactors for Sigma-5 400V Servo Amplifier Type SGDV-3R5D - 5R4D	260 EUR
X5076	DC Reactors for Sigma-7 400V Servo Amplifier Type SGD7S-8R4D - 120D, SGD7W-2R9D - 5R4D DC Reactors for Sigma-5 400V Servo Amplifier Type SGDV-8R4D - 120D	391 EUR
X5077	DC Reactors for Sigma-7 400V Servo Amplifier Type SGD7S-170D DC Reactors for Sigma-5 400V Servo Amplifier Type SGDV-170D	453 EUR



### Servopack Sigma 7 - Mechatrolink 3 embedded

- @ 380 VAC to 480 VAC, -15% to +10%, 50 Hz/60 Hz
- @ Power: 0.50kW - 15.00 kW
- @ Speed frequency response: 3.1kHz
- @ Enhanced ripple compensation, vibration suppression
- @ One amplifier for linear and rotary motors
- @ Advanced Safety functions SS1, SS2, SLS
- @ Daisy chain connection for 24V DC, and DC Power input
- @ UL-, CE-conform, RoHS-conform
- @ Safety SIL 3 for STO, PL-e, CAT 3

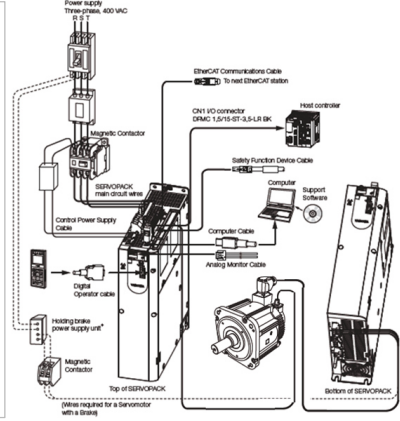

#### Mechatrolink 3 embedded SERVOPACK SGD7S-###B000F64

Ürün Kodu	Açıklama	Liste Fiyatı
SGD7S-1R9D30B000F64	Sigma 7 Servo Amplifier, 0.50kW 3ph, 400V, ML3 embedded	1.377 EUR
SGD7S-3R5D30B000F64	Sigma 7 Servo Amplifier, 1.00kW 3ph, 400V, ML3 embedded	1.396 EUR
SGD7S-5R4D30B000F64	Sigma 7 Servo Amplifier, 1.50kW 3ph, 400V, ML3 embedded	1.462 EUR
SGD7S-8R4D30B000F64	Sigma 7 Servo Amplifier, 2.00kW 3ph, 400V, ML3 embedded	1.481 EUR
SGD7S-120D30B000F64	Sigma 7 Servo Amplifier, 3.00kW 3ph, 400V, ML3 embedded	1.815 EUR
SGD7S-170D30B000F64	Sigma 7 Servo Amplifier, 5.0kW 3ph, 400V, ML3 embedded	2.414 EUR
SGD7S-210D30B000F64	Sigma 7 Servo Amplifier, 5.0kW 3ph, 400V, ML3 embedded	3.502 EUR
SGD7S-260D30B000F64	Sigma 7 Servo Amplifier, 5.0kW 3ph, 400V, ML3 embedded	3.570 EUR
SGD7S-280D30B000F64	Sigma 7 Servo Amplifier, 5.0kW 3ph, 400V, ML3 embedded	3.840 EUR
SGD7S-370D30B000F64	Sigma 7 Servo Amplifier, 5.0kW 3ph, 400V, ML3 embedded	3.929 EUR

#### Mechatrolink 3 embedded SERVOPACK with holding brake relay SGD7S-###B026F64

Ürün Kodu	Açıklama	Liste Fiyatı
SGD7S-1R9D30B026F64	Sigma 7 Servo Amplifier 0.5kW 3ph 400V ML3 embedded, with holding brake relay	1.424 EUR
SGD7S-3R5D30B026F64	Sigma 7 Servo Amplifier 1.0kW 3ph 400V ML3 embedded, with holding brake relay	1.441 EUR
SGD7S-5R4D30B026F64	Sigma 7 Servo Amplifier 1.5kW 3ph 400V ML3 embedded, with holding brake relay	1.509 EUR
SGD7S-8R4D30B026F64	Sigma 7 Servo Amplifier 2.0kW 3ph 400V ML3 embedded, with holding brake relay	1.527 EUR
SGD7S-120D30B026F64	Sigma 7 Servo Amplifier 3.0kW 3ph 400V ML3 embedded, with holding brake relay	1.871 EUR
SGD7S-170D30B026F64	Sigma 7 Servo Amplifier 5.0kW 3ph 400V ML3 embedded, with holding brake relay	2.468 EUR
SGD7S-210D30B026F64	Sigma 7 Servo Amplifier 5.0kW 3ph 400V ML3 embedded, with holding brake relay	3.580 EUR
SGD7S-260D30B026F64	Sigma 7 Servo Amplifier 5.0kW 3ph 400V ML3 embedded, with holding brake relay	3.647 EUR
SGD7S-280D30B026F64	Sigma 7 Servo Amplifier 5.0kW 3ph 400V ML3 embedded, with holding brake relay	3.917 EUR
SGD7S-370D30B026F64	Sigma 7 Servo Amplifier 5.0kW 3ph 400V ML3 embedded, with holding brake relay	4.007 EUR

#### Mechatrolink 3 embedded DUAL AXIS SERVOPACK SGD7W-###D30B

Ürün Kodu	Açıklama	Liste Fiyatı
SGD7W-2R6D30B	Sigma 7 Servo Dual Axis Amplifier 2x 0.75kW 3ph 400V ML3 embedded	2.229 EUR
SGD7W-5R4D30B	Sigma 7 Servo Dual Axis Amplifier 2x 1.50kW 3ph 400V ML3 embedded	2.327 EUR

#### Mechatrolink 3 embedded DUAL AXIS SERVOPACK with holding brake relay SGD7W-###D30B026

Ürün Kodu	Açıklama	Liste Fiyatı
SGD7W-2R6D30B026	Sigma 7 Servo Dual Axis Amplifier 2x 0.75kW 3ph 400V ML3 embedded, with holding brake relay	2.277 EUR
SGD7W-5R4D30B026	Sigma 7 Servo Dual Axis Amplifier 2x 1.50kW 3ph 400V ML3 embedded, with holding brake relay	2.375 EUR

Mechatrolink 3 embedded SERVOPACK accessories SGD7S-###D30

Ürün Kodu	Açıklama	Liste Fiyatı
JUSP-7CN001	I/O connector (CN1), Sigma 7 400V Amplifier	24 EUR
JUSP-7CN101	CN101 Power Input connector, Sigma 7 400V Amplifier SGD7S-1R9D to -170D; SGD7W-xxxD	14 EUR
JUSP-7CN101-1	CN101 Power Input connector, Sigma 7 400V Amplifier SGD7S-210D to -370D	28 EUR
JUSP-7CN102	CN102 Motor power connector, Sigma 7 400V Amplifier SGD7S-1R9D to -170D; SGD7W-xxxD	8 EUR
JUSP-7CN102-1	CN102 Motor power connector, Sigma 7 400V Amplifier SGD7S-210D to -370D	17 EUR
JUSP-7CN103	CN103 Power DC Input connector, Sigma 7 400V Amplifier SGD7S-1R9D to -170D; SGD7W-xxxD	10 EUR
JUSP-7CN103-1	CN103 Power DC Input connector, Sigma 7 400V Amplifier SGD7S-210D to -370D	17 EUR
JUSP-7CN115	CN115 DB Resistor connector for external DB, Sigma 7 400V Amplifier	7 EUR
JUSP-7CN117	CN117 Brake power connector, Sigma 7 400V Amplifier	3 EUR
JUSP-7CN201	CN201 24VDC Input connector, Sigma 7 400V Amplifier	3 EUR
JUSP-OP05A-1-E	CN3 Digital Operator with connection cable 1m	432 EUR
JZSP-CVS05-A3-E	CN3 Digital Operator convertor cable with Connectors at both ends 0.3m	161 EUR
JZSP-CVS07-A3-E	CN3 Digital Operator convertor cable with lock screws 0.3m	215 EUR
JZSP-CA01-E	CN5 Cable for Analog Monitor 1m	20 EUR
JZSP-CM3RRM0-00P2-E	MECHATROLINK-III communication cable with RJ45 connectors on both ends (0,2m)	81 EUR
JZSP-CM3RRM0-00P5-E	MECHATROLINK-III communication cable with RJ45 connectors on both ends (0,5m)	84 EUR
JZSP-CM3RRM0-01-E	MECHATROLINK-III communication cable with RJ45 connectors on both ends (1m)	91 EUR
JZSP-CM3RRM0-03-E	MECHATROLINK-III communication cable with RJ45 connectors on both ends (3m)	112 EUR
JZSP-CM3RRM0-05-E	MECHATROLINK-III communication cable with RJ45 connectors on both ends (5m)	129 EUR
JZSP-CM3RRM0-10-E	MECHATROLINK-III communication cable with RJ45 connectors on both ends (10m)	183 EUR
JZSP-CM3RRM0-20-E	MECHATROLINK-III communication cable with RJ45 connectors on both ends (20m)	Sorunuz
JZSP-CM3RRM0-30-E	MECHATROLINK-III communication cable with RJ45 connectors on both ends (30m)	Sorunuz
JZSP-CM3RRM0-40-E	MECHATROLINK-III communication cable with RJ45 connectors on both ends (40m)	Sorunuz
JZSP-CM3RRM0-50-E	MECHATROLINK-III communication cable with RJ45 connectors on both ends (50m)	Sorunuz
JZSP-CM3RRM0-00P2-E	MECHATROLINK-III communication cable with RJ45/IMI connectors (0,2m)	81 EUR
JZSP-CM3RRM0-00P5-E	MECHATROLINK-III communication cable with RJ45/IMI connectors (0,5m)	84 EUR
JZSP-CM3RRM0-01-E	MECHATROLINK-III communication cable with RJ45/IMI connectors (1m)	88 EUR
JZSP-CM3RRM0-03-E	MECHATROLINK-III communication cable with RJ45/IMI connectors (3m)	109 EUR
JZSP-CM3RRM0-05-E	MECHATROLINK-III communication cable with RJ45/IMI connectors (5m)	129 EUR
JZSP-CM3RRM0-10-E	MECHATROLINK-III communication cable with RJ45/IMI connectors (10m)	179 EUR
JZSP-CM3RRM0-20-E	MECHATROLINK-III communication cable with RJ45/IMI connectors (20m)	Sorunuz
JZSP-CM3RRM0-30-E	MECHATROLINK-III communication cable with RJ45/IMI connectors (30m)	Sorunuz
JZSP-CM3RRM0-40-E	MECHATROLINK-III communication cable with RJ45/IMI connectors (40m)	Sorunuz
JZSP-CM3RRM0-50-E	MECHATROLINK-III communication cable with RJ45/IMI connectors (50m)	Sorunuz
JZSP-CVS06-02-E	CN7 connection cable for PC 2.5m	113 EUR
JZSP-CVH03-03-E-G5	CN8 Cable with connector for safety functions 3m	60 EUR
JZSP-CVH05-E	CN8 Jumper Connector	27 EUR
2013595-1	CN8 Connector kit for safety cables	18 EUR
JZSP-CLP70-03-E-G5	CN31 Cable for connecting serial converter for Fully-closed for Sigma-7 (3m)	161 EUR
JZSP-CLP70-05-E-G5	CN31 Cable for connecting serial converter for Fully-closed for Sigma-7 (5m)	200 EUR
JZSP-CLP70-10-E-G5	CN31 Cable for connecting serial converter for Fully-closed for Sigma-7 (10m)	295 EUR
JZSP-CLP70-15-E-G5	CN31 Cable for connecting serial converter for Fully-closed for Sigma-7 (15m)	389 EUR
JZSP-P7R2-8-E	Sigma-7 Mounting rail for option cards	32 EUR
KLBLUE 4-13.5 SC	Shielding clamp for motor cable 4-13.5mm <sup>2</sup> for Servopacks: Sigma 7 400V up to 3.0 kW, Sigma 7 200V 1.5 kW 1ph, Sigma 5 200V 1.5 kW 1ph	7 EUR
KLBLUE 10-20 SC	Shielding clamp for motor cable 10-20mm for Servopacks: Sigma 7 400V 5.0kW to 7.5kW	17 EUR
KLBLUE 15-32_SC	Shielding clamp for motor cable 15-32mm for Servopacks: Sigma 7 400V 11kW and 15kW	21 EUR
SGDV-OSA01A000FT900	Advanced Safety Option Card for Sigma 7 400V only	179 EUR
SGDV-OFB01A	Option Feedback Module for EnDat-2.1,EnDat-2.2, Hiperface, Sin/Cos	350 EUR
SGDV-OFB03A	Option Feedback Module for TTL Encoder	400 EUR
SGDV-OFB04A	Option Feedback Module for Resolver encoder	425 EUR
SGDV-OFA01A	Fully-closed Loop Option Card	81 EUR
JZDP-H003-XXX	Serial Converter for external Encoder Heidenhain, 8 bit resolution	521 EUR
JZDP-H005-XXX	Serial Converter for external Encoder Renishaw, 8 bit resolution	521 EUR
JZDP-J003-XXX	Serial Converter for external Encoder Heidenhain, 12 bit resolution	573 EUR
JZDP-J005-XXX	Serial Converter for external Encoder Renishaw, 12 bit resolution	573 EUR



**Filters for SGD7S Servopacks (Filters for main power only!)**

Ürün Kodu	Açıklama	Liste Fiyatı
FESS-4009A	Noise Filter for Sigma-7 for SGD7S-1R9D - 120D Type 400V Servo Amplifier	84 EUR
FESS-4015A	Noise Filter for Sigma-7 for SGD7S-170D Type 400V Servo Amplifier	144 EUR
FESS-4022A	Noise Filter for Sigma-7 for SGD7S-210D - 260D Type 400V Servo Amplifier	Sorunuz
FESS-4044A	Noise Filter for Sigma-7 for SGD7S-280D - 370D Type 400V Servo Amplifier	Sorunuz

**DC Reactors for SGD7S Servopacks**

Ürün Kodu	Açıklama	Liste Fiyatı
X5074	DC Reactors for Sigma-7 400V Servo Amplifier Type SGD7S-1R9D DC Reactors for Sigma-5 400V Servo Amplifier Type SGD7S-1R9D	203 EUR
X5075	DC Reactors for Sigma-7 400V Servo Amplifier Type SGD7S-3R5D - 5R4D, SGD7W-2R9D - 5R4D DC Reactors for Sigma-5 400V Servo Amplifier Type SGD7S-3R5D - 5R4D	260 EUR
X5076	DC Reactors for Sigma-7 400V Servo Amplifier Type SGD7S-8R4D - 120D, SGD7W-2R9D - 5R4D DC Reactors for Sigma-5 400V Servo Amplifier Type SGD7S-8R4D - 120D	391 EUR
X5077	DC Reactors for Sigma-7 400V Servo Amplifier Type SGD7S-170D DC Reactors for Sigma-5 400V Servo Amplifier Type SGD7S-170D	453 EUR

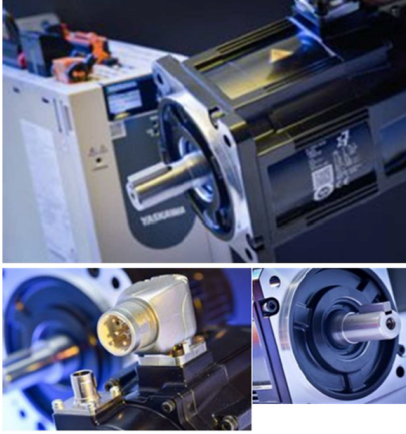

## Medium Inertia, High Speed Servomotor Sigma 7 Series (SGM7J)

- @ 0.20 - 1.50 kW
- @ 400V
- @ 3.000 rpm rated speed, 6.000 rpm max. speed
- @ 0.637-4.77 Nm rated torque
- @ Optional 24VDC holding brake
- @ Optional Special Oil Seal
- @ CE certified, cULus-listed and RoHS conform
- @ IP67

### SGM7J Medium Inertia Servo motor with 24-bit Incremental Encoder

Ürün Kodu	Açıklama	Liste Fiyatı
SGM7J-02DFF61	AC Motor 400V 3ph, 0.20kW (0.637Nm rated, 2.23Nm peak), Rated Speed 3000rpm, Maximum Speed 6000rpm, 24bit IncEnc, shaft end straight with key and tap	844 EUR
SGM7J-04DFF61	AC Motor 400V 3ph, 0.40kW (1.27Nm rated, 4.46Nm peak), Rated Speed 3000rpm, Maximum Speed 6000rpm, 24bit IncEnc, shaft end straight with key and tap	1.008 EUR
SGM7J-08DFF61	AC Motor 400V 3ph, 0.75kW (2.39Nm rated, 8.36Nm peak), Rated Speed 3000rpm, Maximum Speed 6000rpm, 24bit IncEnc, shaft end straight with key and tap	1.189 EUR
SGM7J-15DFF61	AC Motor 400V 3ph, 1.50kW (4.77Nm rated, 14.3Nm peak), Rated Speed 3000rpm, Maximum Speed 6000rpm, 24bit IncEnc, shaft end straight with key and tap	1.232 EUR

### SGM7J Medium Inertia Servo motor with 24-bit Incremental Encoder + Brake

Ürün Kodu	Açıklama	Liste Fiyatı
SGM7J-02DFF6C	AC Motor 400V 3ph, 0.20kW (0.637Nm rated, 2.23Nm peak), Rated Speed 3000rpm, Maximum Speed 6000rpm, 24bit IncEnc, Brake, shaft end straight with key and tap	1.118 EUR
SGM7J-04DFF6C	AC Motor 400V 3ph, 0.40kW (1.27Nm rated, 4.46Nm peak), Rated Speed 3000rpm, Maximum Speed 6000rpm, 24bit IncEnc, Brake, shaft end straight with key and tap	1.215 EUR
SGM7J-08DFF6C	AC Motor 400V 3ph, 0.75kW (2.39Nm rated, 8.36Nm peak), Rated Speed 3000rpm, Maximum Speed 6000rpm, 24bit IncEnc, Brake, shaft end straight with key and tap	1.465 EUR
SGM7J-15DFF6C	AC Motor 400V 3ph, 1.50kW (4.77Nm rated, 14.3Nm peak), Rated Speed 3000rpm, Maximum Speed 6000rpm, 24bit IncEnc, Brake, shaft end straight with key and tap	1.510 EUR

### SGM7J Medium Inertia Servo motor with 24-bit Absolut Encoder

Ürün Kodu	Açıklama	Liste Fiyatı
SGM7J-02D7F61	AC Motor 400V 3ph, 0.20kW (0.637Nm rated, 2.23Nm peak), Rated Speed 3000rpm, Maximum Speed 6000rpm, 24bit AbsEnc, shaft end straight with key and tap	986 EUR
SGM7J-04D7F61	AC Motor 400V 3ph, 0.40kW (1.27Nm rated, 4.46Nm peak), Rated Speed 3000rpm, Maximum Speed 6000rpm, 24bit AbsEnc, shaft end straight with key and tap	1.151 EUR
SGM7J-08D7F61	AC Motor 400V 3ph, 0.75kW (2.39Nm rated, 8.36Nm peak), Rated Speed 3000rpm, Maximum Speed 6000rpm, 24bit AbsEnc, shaft end straight with key and tap	1.338 EUR
SGM7J-15D7F61	AC Motor 400V 3ph, 1.50kW (4.77Nm rated, 14.3Nm peak), Rated Speed 3000rpm, Maximum Speed 6000rpm, 24bit AbsEnc, shaft end straight with key and tap	1.377 EUR

## SGM7J Medium Inertia Servo motor with 24-bit Absolut Encoder + Brake

Ürün Kodu	Açıklama	Liste Fiyatı
SGM7J-02D7F6C	AC Motor 400V 3ph, 0.20kW (0.637Nm rated, 2.23Nm peak), Rated Speed 3000rpm, Maximum Speed 6000rpm, 24bit AbsEnc, Brake, shaft end straight with key and tap	1.267 EUR
SGM7J-04D7F6C	AC Motor 400V 3ph, 0.40kW (1.27Nm rated, 4.46Nm peak), Rated Speed 3000rpm, Maximum Speed 6000rpm, 24bit AbsEnc, Brake, shaft end straight with key and tap	1.357 EUR
SGM7J-08D7F6C	AC Motor 400V 3ph, 0.75kW (2.39Nm rated, 8.36Nm peak), Rated Speed 3000rpm, Maximum Speed 6000rpm, 24bit AbsEnc, Brake, shaft end straight with key and tap	1.612 EUR
SGM7J-15D7F6C	AC Motor 400V 3ph, 1.50kW (4.77Nm rated, 14.3Nm peak), Rated Speed 3000rpm, Maximum Speed 6000rpm, 24bit AbsEnc, Brake, shaft end straight with key and tap	1.653 EUR

## Servo Motor Power Cable flexible type 0.20 to 1.50kW SGM7J

Ürün Kodu	Açıklama	Liste Fiyatı
JZSP-C7M143-03-E-G6	Flexible Power cable (3m) 4 x 1.5mm <sup>2</sup> with M17 connector for SGM7J (0.20-0.75kW), SGM7A (0.40-0.75kW), SGLFW2-30D070 to SGLFW2-45D380, SGLFW2-30A070 to SGLFW2-30A230	95 EUR
JZSP-C7M143-05-E-G6	Flexible Power cable (5m) 4 x 1.5mm <sup>2</sup> with M17 connector for SGM7J (0.20-0.75kW), SGM7A (0.40-0.75kW), SGLFW2-30D070 to SGLFW2-45D380, SGLFW2-30A070 to SGLFW2-30A230	116 EUR
JZSP-C7M143-10-E-G6	Flexible Power cable (10m) 4 x 1.5mm <sup>2</sup> with M17 connector for SGM7J (0.20-0.75kW), SGM7A (0.40-0.75kW), SGLFW2-30D070 to SGLFW2-45D380, SGLFW2-30A070 to SGLFW2-30A230	172 EUR
JZSP-C7M143-15-E-G6	Flexible Power cable (15m) 4 x 1.5mm <sup>2</sup> with M17 connector for SGM7J (0.20-0.75kW), SGM7A (0.40-0.75kW), SGLFW2-30D070 to SGLFW2-45D380, SGLFW2-30A070 to SGLFW2-30A230	243 EUR
JZSP-C7M143-20-E-G6	Flexible Power cable (20m) 4 x 1.5mm <sup>2</sup> with M17 connector for SGM7J (0.20-0.75kW), SGM7A (0.40-0.75kW), SGLFW2-30D070 to SGLFW2-45D380, SGLFW2-30A070 to SGLFW2-30A230	303 EUR
JZSP-C7M144-03-E-G6	Flexible Power cable (3m) 4 x 1.5mm <sup>2</sup> with M23 connector for SGM7J (1.5kW), SGM7A (1.0-2.5kW), SGM7G (0.5kW-2.0kW), SGM7G (0.5 to 0.9kW) High Speed, SGLFW2-45A200	105 EUR
JZSP-C7M144-05-E-G6	Flexible Power cable (5m) 4 x 1.5mm <sup>2</sup> with M23 connector for SGM7J (1.5kW), SGM7A (1.0-2.5kW), SGM7G (0.5kW-2.0kW), SGM7G (0.5 to 0.9kW) High Speed, SGLFW2-45A200	124 EUR
JZSP-C7M144-10-E-G6	Flexible Power cable (10m) 4 x 1.5mm <sup>2</sup> with M23 connector for SGM7J (1.5kW), SGM7A (1.0-2.5kW), SGM7G (0.5kW-2.0kW), SGM7G (0.5 to 0.9kW) High Speed, SGLFW2-45A200	183 EUR
JZSP-C7M144-15-E-G6	Flexible Power cable (15m) 4 x 1.5mm <sup>2</sup> with M23 connector for SGM7J (1.5kW), SGM7A (1.0-2.5kW), SGM7G (0.5kW-2.0kW), SGM7G (0.5 to 0.9kW) High Speed, SGLFW2-45A200	253 EUR
JZSP-C7M144-20-E-G6	Flexible Power cable (20m) 4 x 1.5mm <sup>2</sup> with M23 connector for SGM7J (1.5kW), SGM7A (1.0-2.5kW), SGM7G (0.5kW-2.0kW), SGM7G (0.5 to 0.9kW) High Speed, SGLFW2-45A200	313 EUR

## Servo Motor Power Cable flexible type for Motors with Brake 0.20 to 1.50kW SGM7J

Ürün Kodu	Açıklama	Liste Fiyatı
JZSP-C7M343-03-E-G6	Flexible Power + Brake cable (3m) 4 x 1.5mm <sup>2</sup> + 2 x 1.5mm <sup>2</sup> with M17 connector for SGM7J (0.20-0.75kW), SGM7A (0.40-0.75kW)	124 EUR
JZSP-C7M343-05-E-G6	Flexible Power + Brake cable (5m) 4 x 1.5mm <sup>2</sup> + 2 x 1.5mm <sup>2</sup> with M17 connector for SGM7J (0.20-0.75kW), SGM7A (0.40-0.75kW)	155 EUR
JZSP-C7M343-10-E-G6	Flexible Power + Brake cable (10m) 4 x 1.5mm <sup>2</sup> + 2 x 1.5mm <sup>2</sup> with M17 connector for SGM7J (0.20-0.75kW), SGM7A (0.40-0.75kW)	243 EUR
JZSP-C7M343-15-E-G6	Flexible Power + Brake cable (15m) 4 x 1.5mm <sup>2</sup> + 2 x 1.5mm <sup>2</sup> with M17 connector for SGM7J (0.20-0.75kW), SGM7A (0.40-0.75kW)	348 EUR
JZSP-C7M343-20-E-G6	Flexible Power + Brake cable (20m) 4 x 1.5mm <sup>2</sup> + 2 x 1.5mm <sup>2</sup> with M17 connector for SGM7J (0.20-0.75kW), SGM7A (0.40-0.75kW)	440 EUR
JZSP-C7M344-03-E-G6	Flexible Power + Brake cable (3m) 4 x 1.5mm <sup>2</sup> + 2 x 1.5mm <sup>2</sup> M23 connector for SGM7J (1.5kW), SGM7A (1.0-2.5kW), SGM7G (0.5kW-2.0kW), SGM7G-05 to -09 High Speed	124 EUR
JZSP-C7M344-05-E-G6	Flexible Power + Brake cable (5m) 4 x 1.5mm <sup>2</sup> + 2 x 1.5mm <sup>2</sup> M23 connector for SGM7J (1.5kW), SGM7A (1.0-2.5kW), SGM7G (0.5kW-2.0kW), SGM7G-05 to -09 High Speed	155 EUR
JZSP-C7M344-10-E-G6	Flexible Power + Brake cable (10m) 4 x 1.5mm <sup>2</sup> + 2 x 1.5mm <sup>2</sup> M23 connector for SGM7J (1.5kW), SGM7A (1.0-2.5kW), SGM7G (0.5kW-2.0kW), SGM7G-05 to -09 High Speed	243 EUR
JZSP-C7M344-15-E-G6	Flexible Power + Brake cable (15m) 4 x 1.5mm <sup>2</sup> + 2 x 1.5mm <sup>2</sup> M23 connector for SGM7J (1.5kW), SGM7A (1.0-2.5kW), SGM7G (0.5kW-2.0kW), SGM7G-05 to -09 High Speed	348 EUR
JZSP-C7M344-20-E-G6	Flexible Power + Brake cable (20m) 4 x 1.5mm <sup>2</sup> + 2 x 1.5mm <sup>2</sup> M23 connector for SGM7J (1.5kW), SGM7A (1.0-2.5kW), SGM7G (0.5kW-2.0kW), SGM7G-05 to -09 High Speed	440 EUR

## Incremental Encoder Cable flexible type with straight Connector SGM7J

Ürün Kodu	Açıklama	Liste Fiyatı
JZSP-C7PI2M-03-E-G6	Flexible Encoder cable (3m) with straight connector M12 for all Sigma-7 400V Motors	136 EUR
JZSP-C7PI2M-05-E-G6	Flexible Encoder cable (5m) with straight connector M12 for all Sigma-7 400V Motors	155 EUR
JZSP-C7PI2M-10-E-G6	Flexible Encoder cable (10m) with straight connector M12 for all Sigma-7 400V Motors	216 EUR
JZSP-C7PI2M-15-E-G6	Flexible Encoder cable (15m) with straight connector M12 for all Sigma-7 400V Motors	282 EUR
JZSP-C7PI2M-20-E-G6	Flexible Encoder cable (20m) with straight connector M12 for all Sigma-7 400V Motors	344 EUR

## Incremental Encoder Cable flexible type with angled Connector SGM7J

Ürün Kodu	Açıklama	Liste Fiyatı
JZSP-C7PI2N-03-E-G6	Flexible Encoder cable (3m) with angled connector M12 for all Sigma-7 400V Motors	140 EUR
JZSP-C7PI2N-05-E-G6	Flexible Encoder cable (5m) with angled connector M12 for all Sigma-7 400V Motors	155 EUR
JZSP-C7PI2N-10-E-G6	Flexible Encoder cable (10m) with angled connector M12 for all Sigma-7 400V Motors	220 EUR
JZSP-C7PI2N-15-E-G6	Flexible Encoder cable (15m) with angled connector M12 for all Sigma-7 400V Motors	282 EUR
JZSP-C7PI2N-20-E-G6	Flexible Encoder cable (20m) with angled connector M12 for all Sigma-7 400V Motors	348 EUR

## Special Cable for Extension for Absolut Encoder

Ürün Kodu	Açıklama	Liste Fiyatı
JZSP-CSP12-E-G5	Extension Encoder cable with Connectors length 0.3m for Abs. Encoder, incl. Battery	100 EUR



### Low Inertia, High Speed Servomotor Sigma 7 Series (SGM7A)

- @ 0.20 - 7.00kW
- @ 400V
- @ 3.000 rpm rated speed, 6.000 rpm max. speed
- @ 0.637-22.3 Nm rated torque
- @ 2.23- 54.0 Nm Peak torque
- @ Optional 24VDC holding brake
- @ Optional Special Oil Seal
- @ CE certified, cULus-listed and RoHS conform
- @ IP67

#### SGM7A Low Inertia Servo motor with 24-bit Incremental Encoder

Ürün Kodu	Açıklama	Liste Fiyatı
SGM7A-02DFF61	AC Motor 400V 3ph, 0.20kW (0.637Nm rated, 2.23Nm peak), Rated Speed 3000rpm, Maximum Speed 6000rpm, 24bit IncEnc, shaft end straight with key and tap	844 EUR
SGM7A-04DFF61	AC Motor 400V 3ph, 0.40kW (1.27Nm rated, 4.46Nm peak), Rated Speed 3000rpm, Maximum Speed 6000rpm, 24bit IncEnc, shaft end straight with key and tap	1.008 EUR
SGM7A-08DFF61	AC Motor 400V 3ph, 0.75kW (2.39Nm rated, 8.36Nm peak), Rated Speed 3000rpm, Maximum Speed 6000rpm, 24bit IncEnc, shaft end straight with key and tap	1.189 EUR
SGM7A-10DFF61	AC Motor 400V 3ph, 1.00kW (3.18Nm rated, 11.1Nm Peak), Rated Speed 3000rpm, Maximum Speed 6000rpm, 24bit IncEnc, shaft end straight with key and tap	1.158 EUR
SGM7A-15DFF6F	AC Motor 400V 3ph, 1.50kW (4.9Nm rated, 14.7Nm peak), Rated Speed 3000rpm, Maximum Speed 6000rpm, 24bit IncEnc, DustS, shaft end straight with key and tap	1.259 EUR
SGM7A-20DFF6F	AC Motor 400V 3ph, 2.00kW (6.36Nm rated, 19.1Nm peak), Rated Speed 3000rpm, Maximum Speed 6000rpm, 24bit IncEnc, DustS, shaft end straight with key and tap	1.357 EUR
SGM7A-25DFF6F	AC Motor 400V 3ph, 2.50kW (7.96Nm rated, 23.9Nm peak), Rated Speed 3000rpm, Maximum Speed 5000rpm, 24bit IncEnc, DustS, shaft end straight with key and tap	1.406 EUR
SGM7A-30DFF6F	AC Motor 400V 3ph, 3.00kW (9.8Nm rated, 29.4Nm peak), Rated Speed 3000rpm, Maximum Speed 6000rpm, 24bit IncEnc, DustS, shaft end straight with key and tap	1.668 EUR
SGM7A-40DFF6F	AC Motor 400V 3ph, 4.00kW (12.6Nm rated, 37.8Nm peak), Rated Speed 3000rpm, Maximum Speed 6000rpm, 20bit IncEnc, DustS, shaft end straight with key and tap	1.892 EUR
SGM7A-50DFF6F	AC Motor 400V 3ph, 5.00kW (15.8Nm rated, 47.6Nm peak), Rated Speed 3000rpm, Maximum Speed 6000rpm, 20bit IncEnc, DustS, shaft end straight with key and tap	2.507 EUR
SGM7A-70DFF6F	AC Motor 400V 3ph, 7.00kW (22.3Nm rated, 54.0Nm peak), Rated Speed 3000rpm, Maximum Speed 6000rpm, 20bit IncEnc, DustS, shaft end straight with key and tap	3.787 EUR

#### SGM7A Low Inertia Servo motor with 24-bit Incremental Encoder+Brake

Ürün Kodu	Açıklama	Liste Fiyatı
SGM7A-02DFF6C	AC Motor 400V 3ph, 0.20kW (0.637Nm rated, 2.23Nm peak), Rated Speed 3000rpm, Maximum Speed 6000rpm, 24bit IncEnc, Brake, shaft end straight with key and tap	1.118 EUR
SGM7A-04DFF6C	AC Motor 400V 3ph, 0.40kW (1.27Nm rated, 4.46Nm peak), Rated Speed 3000rpm, Maximum Speed 6000rpm, 24bit IncEnc, Brake, shaft end straight with key and tap	1.215 EUR
SGM7A-08DFF6C	AC Motor 400V 3ph, 0.75kW (2.39Nm rated, 8.36Nm peak), Rated Speed 3000rpm, Maximum Speed 6000rpm, 24bit IncEnc, Brake, shaft end straight with key and tap	1.465 EUR
SGM7A-10DFF6C	AC Motor 400V 3ph, 1.00kW (3.18Nm rated, 11.1Nm Peak), Rated Speed 3000rpm, Maximum Speed 6000rpm, 24bit IncEnc, Brake, shaft end straight with key and tap	1.308 EUR
SGM7A-15DFF6H	AC Motor 400V 3ph, 1.50kW (4.9Nm rated, 14.7Nm peak), Rated Speed 3000rpm, Maximum Speed 6000rpm, 24bit IncEnc, DustS + Brake, shaft end straight with key and tap	1.450 EUR
SGM7A-20DFF6H	AC Motor 400V 3ph, 2.00kW (6.36Nm rated, 19.1Nm peak), Rated Speed 3000rpm, Maximum Speed 6000rpm, 24bit IncEnc, DustS + Brake, shaft end straight with key and tap	1.596 EUR
SGM7A-25DFF6H	AC Motor 400V 3ph, 2.50kW (7.96Nm rated, 23.9Nm peak), Rated Speed 3000rpm, Maximum Speed 5000rpm, 24bit IncEnc, DustS + Brake, shaft end straight with key and tap	1.596 EUR
SGM7A-30DFF6H	AC Motor 400V 3ph, 3.00kW (9.8Nm rated, 29.4Nm peak), Rated Speed 3000rpm, Maximum Speed 6000rpm, 24bit IncEnc, DustS + Brake, shaft end straight with key and tap	2.392 EUR
SGM7A-40DFF6H	AC Motor 400V 3ph, 4.00kW (12.6Nm rated, 37.8Nm peak), Rated Speed 3000rpm, Maximum Speed 6000rpm, 20bit IncEnc, DustS + Brake, shaft end straight with key and tap	2.727 EUR
SGM7A-50DFF6H	AC Motor 400V 3ph, 5.00kW (15.8Nm rated, 47.6Nm peak), Rated Speed 3000rpm, Maximum Speed 6000rpm, 20bit IncEnc, DustS + Brake, shaft end straight with key and tap	3.339 EUR

**SGM7A Low Inertia Servo motor with 24-bit Absolute Encoder**

Ürün Kodu	Açıklama	Liste Fiyatı
SGM7A-02D7F61	AC Motor 400V 3ph, 0.20kW (0.637Nm rated, 2.23Nm peak), Rated Speed 3000rpm, Maximum Speed 6000rpm, 24bit AbsEnc, shaft end straight with key and tap	986 EUR
SGM7A-04D7F61	AC Motor 400V 3ph, 0.40kW (1.27Nm rated, 4.46Nm peak), Rated Speed 3000rpm, Maximum Speed 6000rpm, 24bit AbsEnc, shaft end straight with key and tap	1.151 EUR
SGM7A-08D7F61	AC Motor 400V 3ph, 0.75kW (2.39Nm rated, 8.36Nm peak), Rated Speed 3000rpm, Maximum Speed 6000rpm, 24bit AbsEnc, shaft end straight with key and tap	1.338 EUR
SGM7A-10D7F61	AC Motor 400V 3ph, 1.00kW (3.18Nm rated, 11.1Nm Peak), Rated Speed 3000rpm, Maximum Speed 6000rpm, 24bit AbsEnc, shaft end straight with key and tap	1.308 EUR
SGM7A-15D7F6F	AC Motor 400V 3ph, 1.50kW (4.9Nm rated, 14.7Nm peak), Rated Speed 3000rpm, Maximum Speed 6000rpm, 24bit AbsEnc, DustS, shaft end straight with key and tap	1.406 EUR
SGM7A-20D7F6F	AC Motor 400V 3ph, 2.00kW (6.36Nm rated, 19.1Nm peak), Rated Speed 3000rpm, Maximum Speed 6000rpm, 24bit AbsEnc, DustS, shaft end straight with key and tap	1.500 EUR
SGM7A-25D7F6F	AC Motor 400V 3ph, 2.50kW (7.96Nm rated, 23.9Nm peak), Rated Speed 3000rpm, Maximum Speed 6000rpm, 24bit AbsEnc, DustS, shaft end straight with key and tap	1.549 EUR
SGM7A-30D7F6F	AC Motor 400V 3ph, 3.00kW (9.8Nm rated, 29.4Nm peak), Rated Speed 3000rpm, Maximum Speed 6000rpm, 24bit AbsEnc, DustS, shaft end straight with key and tap	1.835 EUR
SGM7A-40D7F6F	AC Motor 400V 3ph, 4.00kW (12.6Nm rated, 37.8Nm peak), Rated Speed 3000rpm, Maximum Speed 6000rpm, 20bit AbsEnc, DustS, shaft end straight with key and tap	2.059 EUR
SGM7A-50D7F6F	AC Motor 400V 3ph, 5.00kW (15.8Nm rated, 47.6Nm peak), Rated Speed 3000rpm, Maximum Speed 6000rpm, 20bit AbsEnc, DustS, shaft end straight with key and tap	2.671 EUR
SGM7A-70D7F6F	AC Motor 400V 3ph, 7.00kW (22.3Nm rated, 54.0Nm peak), Rated Speed 3000rpm, Maximum Speed 6000rpm, 20bit AbsEnc, DustS, shaft end straight with key and tap	3.951 EUR

**SGM7A Low Inertia Servo motor with 24-bit Absolute Encoder+Brake**

Ürün Kodu	Açıklama	Liste Fiyatı
SGM7A-02D7F6C	AC Motor 400V 3ph, 0.20kW (0.637Nm rated, 2.23Nm peak), Rated Speed 3000rpm, Maximum Speed 6000rpm, 24bit AbsEnc, Brake, shaft end straight with key and tap	1.267 EUR
SGM7A-04D7F6C	AC Motor 400V 3ph, 0.40kW (1.27Nm rated, 4.46Nm peak), Rated Speed 3000rpm, Maximum Speed 6000rpm, 24bit AbsEnc, Brake, shaft end straight with key and tap	1.357 EUR
SGM7A-08D7F6C	AC Motor 400V 3ph, 0.75kW (2.39Nm rated, 8.36Nm peak), Rated Speed 3000rpm, Maximum Speed 6000rpm, 24bit AbsEnc, Brake, shaft end straight with key and tap	1.612 EUR
SGM7A-10D7F6C	AC Motor 400V 3ph, 1.00kW (3.18Nm rated, 11.1Nm Peak), Rated Speed 3000rpm, Maximum Speed 6000rpm, 24bit AbsEnc, Brake, shaft end straight with key and tap	1.450 EUR
SGM7A-15D7F6H	AC Motor 400V 3ph, 1.50kW (4.9Nm rated, 14.7Nm peak), Rated Speed 3000rpm, Maximum Speed 6000rpm, 24bit AbsEnc, DustS + Brake, shaft end straight with key and tap	1.596 EUR
SGM7A-20D7F6H	AC Motor 400V 3ph, 2.00kW (6.36Nm rated, 19.1Nm peak), Rated Speed 3000rpm, Maximum Speed 6000rpm, 24bit AbsEnc, DustS + Brake, shaft end straight with key and tap	1.743 EUR
SGM7A-25D7F6H	AC Motor 400V 3ph, 2.50kW (7.96Nm rated, 23.9Nm peak), Rated Speed 3000rpm, Maximum Speed 5000rpm, 24bit AbsEnc, DustS + Brake, shaft end straight with key and tap	1.982 EUR
SGM7A-30D7F6H	AC Motor 400V 3ph, 3.00kW (9.8Nm rated, 29.4Nm peak), Rated Speed 3000rpm, Maximum Speed 6000rpm, 24bit AbsEnc, DustS + Brake, shaft end straight with key and tap	2.564 EUR
SGM7A-40D7F6H	AC Motor 400V 3ph, 4.00kW (12.6Nm rated, 37.8Nm peak), Rated Speed 3000rpm, Maximum Speed 6000rpm, 20bit AbsEnc, DustS + Brake, shaft end straight with key and tap	2.891 EUR
SGM7A-50D7F6H	AC Motor 400V 3ph, 5.00kW (15.8Nm rated, 47.6Nm peak), Rated Speed 3000rpm, Maximum Speed 6000rpm, 20bit AbsEnc, DustS + Brake, shaft end straight with key and tap	3.503 EUR

Servo Motor Power Cable flexible type 0.20 to 3.00kW SGM7A

Ürün Kodu	Açıklama	Liste Fiyatı
JZSP-C7M143-03-E-G6	Flexible Power cable (3m) 4 x 1.5mm <sup>2</sup> with M17 connector for SGM7J (0.20-0.75kW), SGM7A (0.40-0.75kW), SGLFW2-30D070 to SGLFW2-45D380, SGLFW2-30A070 to SGLFW2-30A230	95 EUR
JZSP-C7M143-05-E-G6	Flexible Power cable (5m) 4 x 1.5mm <sup>2</sup> with M17 connector for SGM7J (0.20-0.75kW), SGM7A (0.40-0.75kW), SGLFW2-30D070 to SGLFW2-45D380, SGLFW2-30A070 to SGLFW2-30A230	116 EUR
JZSP-C7M143-10-E-G6	Flexible Power cable (10m) 4 x 1.5mm <sup>2</sup> with M17 connector for SGM7J (0.20-0.75kW), SGM7A (0.40-0.75kW), SGLFW2-30D070 to SGLFW2-45D380, SGLFW2-30A070 to SGLFW2-30A230	172 EUR
JZSP-C7M143-15-E-G6	Flexible Power cable (15m) 4 x 1.5mm <sup>2</sup> with M17 connector for SGM7J (0.20-0.75kW), SGM7A (0.40-0.75kW), SGLFW2-30D070 to SGLFW2-45D380, SGLFW2-30A070 to SGLFW2-30A230	243 EUR
JZSP-C7M143-20-E-G6	Flexible Power cable (20m) 4 x 1.5mm <sup>2</sup> with M17 connector for SGM7J (0.20-0.75kW), SGM7A (0.40-0.75kW), SGLFW2-30D070 to SGLFW2-45D380, SGLFW2-30A070 to SGLFW2-30A230	303 EUR
JZSP-C7M144-03-E-G6	Flexible Power cable (3m) 4 x 1.5mm <sup>2</sup> with M23 connector for SGM7J (1.5kW), SGM7A (1.0-2.5kW), SGM7G (0.5kW-2.0kW), SGM7G (0.5 to 0.9kW) High Speed, SGLFW2-45A200	105 EUR
JZSP-C7M144-05-E-G6	Flexible Power cable (5m) 4 x 1.5mm <sup>2</sup> with M23 connector for SGM7J (1.5kW), SGM7A (1.0-2.5kW), SGM7G (0.5kW-2.0kW), SGM7G (0.5 to 0.9kW) High Speed, SGLFW2-45A200	124 EUR
JZSP-C7M144-10-E-G6	Flexible Power cable (10m) 4 x 1.5mm <sup>2</sup> with M23 connector for SGM7J (1.5kW), SGM7A (1.0-2.5kW), SGM7G (0.5kW-2.0kW), SGM7G (0.5 to 0.9kW) High Speed, SGLFW2-45A200	183 EUR
JZSP-C7M144-15-E-G6	Flexible Power cable (15m) 4 x 1.5mm <sup>2</sup> with M23 connector for SGM7J (1.5kW), SGM7A (1.0-2.5kW), SGM7G (0.5kW-2.0kW), SGM7G (0.5 to 0.9kW) High Speed, SGLFW2-45A200	253 EUR
JZSP-C7M144-20-E-G6	Flexible Power cable (20m) 4 x 1.5mm <sup>2</sup> with M23 connector for SGM7J (1.5kW), SGM7A (1.0-2.5kW), SGM7G (0.5kW-2.0kW), SGM7G (0.5 to 0.9kW) High Speed, SGLFW2-45A200	313 EUR
JZSP-C7M154-03-E-G6	Flexible Power cable (3m) 4 x 2.5mm <sup>2</sup> with M23 connector for SGM7A (3.0kW), SGM7G (3.0kW), SGM7G (1.3 to 2.0kW) High Speed, SGLFW2-90D200 to SGLFW2-1DD380, SGLFW2-45A380 to SGLFW2-90A200	127 EUR
JZSP-C7M154-05-E-G6	Flexible Power cable (5m) 4 x 2.5mm <sup>2</sup> with M23 connector for SGM7A (3.0kW), SGM7G (3.0kW), SGM7G (1.3 to 2.0kW) High Speed, SGLFW2-90D200 to SGLFW2-1DD380, SGLFW2-45A380 to SGLFW2-90A200	162 EUR
JZSP-C7M154-10-E-G6	Flexible Power cable (10m) 4 x 2.5mm <sup>2</sup> with M23 connector for SGM7A (3.0kW), SGM7G (3.0kW), SGM7G (1.3 to 2.0kW) High Speed, SGLFW2-90D200 to SGLFW2-1DD380, SGLFW2-45A380 to SGLFW2-90A200	256 EUR
JZSP-C7M154-15-E-G6	Flexible Power cable (15m) 4 x 2.5mm <sup>2</sup> with M23 connector for SGM7A (3.0kW), SGM7G (3.0kW), SGM7G (1.3 to 2.0kW) High Speed, SGLFW2-90D200 to SGLFW2-1DD380, SGLFW2-45A380 to SGLFW2-90A200	362 EUR
JZSP-C7M154-20-E-G6	Flexible Power cable (20m) 4 x 2.5mm <sup>2</sup> with M23 connector for SGM7A (3.0kW), SGM7G (3.0kW), SGM7G (1.3 to 2.0kW) High Speed, SGLFW2-90D200 to SGLFW2-1DD380, SGLFW2-45A380 to SGLFW2-90A200	460 EUR
JZSP-C7M164-03-E-G6	Flexible Power cable (3m) 4 x 4.0mm <sup>2</sup> with M23 connector for SGM7A (4.0kW, 5.0kW), SGM7G (4.4kW), SGM7G (3.0kW) High Speed, SGLFW2-1DD560, SGLFW2-90A380 to SGLFW2-90A560	141 EUR
JZSP-C7M164-05-E-G6	Flexible Power cable (5m) 4 x 4.0mm <sup>2</sup> with M23 connector for SGM7A (4.0kW, 5.0kW), SGM7G (4.4kW), SGM7G (3.0kW) High Speed, SGLFW2-1DD560, SGLFW2-90A380 to SGLFW2-90A560	183 EUR
JZSP-C7M164-10-E-G6	Flexible Power cable (10m) 4 x 4.0mm <sup>2</sup> with M23 connector for SGM7A (4.0kW, 5.0kW), SGM7G (4.4kW), SGM7G (3.0kW) High Speed, SGLFW2-1DD560, SGLFW2-90A380 to SGLFW2-90A560	298 EUR
JZSP-C7M164-15-E-G6	Flexible Power cable (15m) 4 x 4.0mm <sup>2</sup> with M23 connector for SGM7A (4.0kW, 5.0kW), SGM7G (4.4kW), SGM7G (3.0kW) High Speed, SGLFW2-1DD560, SGLFW2-90A380 to SGLFW2-90A560	425 EUR
JZSP-C7M164-20-E-G6	Flexible Power cable (20m) 4 x 4.0mm <sup>2</sup> with M23 connector for SGM7A (4.0kW, 5.0kW), SGM7G (4.4kW), SGM7G (3.0kW) High Speed, SGLFW2-1DD560, SGLFW2-90A380 to SGLFW2-90A560	537 EUR
JZSP-C7M175-03-E-G6	Flexible Power Cable (3m) 4 x 6.0mm <sup>2</sup> with M40 connector for SGM7A (7.0kW), SGM7G (5.5kW-7.5kW), SGM7G-44 High Speed (4.4kW)	250 EUR
JZSP-C7M175-05-E-G6	Flexible Power Cable (5m) 4 x 6.0mm <sup>2</sup> with M40 connector for SGM7A (7.0kW), SGM7G (5.5kW-7.5kW), SGM7G-44 High Speed (4.4kW)	313 EUR
JZSP-C7M175-10-E-G6	Flexible Power Cable (10m) 4 x 6.0mm <sup>2</sup> with M40 connector for SGM7A (7.0kW), SGM7G (5.5kW-7.5kW), SGM7G-44 High Speed (4.4kW)	477 EUR
JZSP-C7M175-15-E-G6	Flexible Power Cable (15m) 4 x 6.0mm <sup>2</sup> with M40 connector for SGM7A (7.0kW), SGM7G (5.5kW-7.5kW), SGM7G-44 High Speed (4.4kW)	671 EUR
JZSP-C7M175-20-E-G6	Flexible Power Cable (20m) 4 x 6.0mm <sup>2</sup> with M40 connector for SGM7A (7.0kW), SGM7G (5.5kW-7.5kW), SGM7G-44 High Speed (4.4kW)	847 EUR

Servo Motor Power Cable flexible type for Motors with Brake 0.20 to 3.00kW SGM7A

Ürün Kodu	Açıklama	Liste Fiyatı
JZSP-C7M343-03-E-G6	Flexible Power + Brake cable (3m) 4 x 1.5mm <sup>2</sup> + 2 x 1.5mm <sup>2</sup> with M17 connector for SGM7J (0.20-0.75kW), SGM7A (0.40-0.75kW)	124 EUR
JZSP-C7M343-05-E-G6	Flexible Power + Brake cable (5m) 4 x 1.5mm <sup>2</sup> + 2 x 1.5mm <sup>2</sup> with M17 connector for SGM7J (0.20-0.75kW), SGM7A (0.40-0.75kW)	155 EUR
JZSP-C7M343-10-E-G6	Flexible Power + Brake cable (10m) 4 x 1.5mm <sup>2</sup> + 2 x 1.5mm <sup>2</sup> with M17 connector for SGM7J (0.20-0.75kW), SGM7A (0.40-0.75kW)	243 EUR
JZSP-C7M343-15-E-G6	Flexible Power + Brake cable (15m) 4 x 1.5mm <sup>2</sup> + 2 x 1.5mm <sup>2</sup> with M17 connector for SGM7J (0.20-0.75kW), SGM7A (0.40-0.75kW)	348 EUR
JZSP-C7M343-20-E-G6	Flexible Power + Brake cable (20m) 4 x 1.5mm <sup>2</sup> + 2 x 1.5mm <sup>2</sup> with M17 connector for SGM7J (0.20-0.75kW), SGM7A (0.40-0.75kW)	440 EUR
JZSP-C7M344-03-E-G6	Flexible Power + Brake cable (3m) 4 x 1.5mm <sup>2</sup> + 2 x 1.5mm <sup>2</sup> M23 connector for SGM7J (1.5kW), SGM7A (1.0-2.5kW), SGM7G (0.5kW-2.0kW), SGM7G-05 to -09 High Speed	124 EUR
JZSP-C7M344-05-E-G6	Flexible Power + Brake cable (5m) 4 x 1.5mm <sup>2</sup> + 2 x 1.5mm <sup>2</sup> M23 connector for SGM7J (1.5kW), SGM7A (1.0-2.5kW), SGM7G (0.5kW-2.0kW), SGM7G-05 to -09 High Speed	155 EUR
JZSP-C7M344-10-E-G6	Flexible Power + Brake cable (10m) 4 x 1.5mm <sup>2</sup> + 2 x 1.5mm <sup>2</sup> M23 connector for SGM7J (1.5kW), SGM7A (1.0-2.5kW), SGM7G (0.5kW-2.0kW), SGM7G-05 to -09 High Speed	243 EUR
JZSP-C7M344-15-E-G6	Flexible Power + Brake cable (15m) 4 x 1.5mm <sup>2</sup> + 2 x 1.5mm <sup>2</sup> M23 connector for SGM7J (1.5kW), SGM7A (1.0-2.5kW), SGM7G (0.5kW-2.0kW), SGM7G-05 to -09 High Speed	348 EUR
JZSP-C7M344-20-E-G6	Flexible Power + Brake cable (20m) 4 x 1.5mm <sup>2</sup> + 2 x 1.5mm <sup>2</sup> M23 connector for SGM7J (1.5kW), SGM7A (1.0-2.5kW), SGM7G (0.5kW-2.0kW), SGM7G-05 to -09 High Speed	440 EUR
JZSP-C7M354-03-E-G6	Flexible Power + Brake cable (3m) 4 x 2.5mm <sup>2</sup> + 2 x 1.5mm <sup>2</sup> M23 connector for SGM7A (3.0kW), SGM7G (3.0kW), SGM7G (1.3 to 2.0kW) High Speed	143 EUR
JZSP-C7M354-05-E-G6	Flexible Power + Brake cable (5m) 4 x 2.5mm <sup>2</sup> + 2 x 1.5mm <sup>2</sup> M23 connector for SGM7A (3.0kW), SGM7G (3.0kW), SGM7G (1.3 to 2.0kW) High Speed	189 EUR
JZSP-C7M354-10-E-G6	Flexible Power + Brake cable (10m) 4 x 2.5mm <sup>2</sup> + 2 x 1.5mm <sup>2</sup> M23 connector for SGM7A (3.0kW), SGM7G (3.0kW), SGM7G (1.3 to 2.0kW) High Speed	313 EUR
JZSP-C7M354-15-E-G6	Flexible Power + Brake cable (15m) 4 x 2.5mm <sup>2</sup> + 2 x 1.5mm <sup>2</sup> M23 connector for SGM7A (3.0kW), SGM7G (3.0kW), SGM7G (1.3 to 2.0kW) High Speed	451 EUR
JZSP-C7M354-20-E-G6	Flexible Power + Brake cable (20m) 4 x 2.5mm <sup>2</sup> + 2 x 1.5mm <sup>2</sup> M23 connector for SGM7A (3.0kW), SGM7G (3.0kW), SGM7G (1.3 to 2.0kW) High Speed	575 EUR
JZSP-C7M364-03-E-G6	Flexible Power + Brake cable (3m) 4 x 4.0mm <sup>2</sup> + 2 x 1.5mm <sup>2</sup> M23 connector for SGM7A (4.0kW, 5.0kW), SGM7G (4.4kW), SGM7G (3.0kW) High Speed	179 EUR
JZSP-C7M364-05-E-G6	Flexible Power + Brake cable (5m) 4 x 4.0mm <sup>2</sup> + 2 x 1.5mm <sup>2</sup> M23 connector for SGM7A (4.0kW, 5.0kW), SGM7G (4.4kW), SGM7G (3.0kW) High Speed	246 EUR
JZSP-C7M364-10-E-G6	Flexible Power + Brake cable (10m) 4 x 4.0mm <sup>2</sup> + 2 x 1.5mm <sup>2</sup> M23 connector for SGM7A (4.0kW, 5.0kW), SGM7G (4.4kW), SGM7G (3.0kW) High Speed	415 EUR
JZSP-C7M364-15-E-G6	Flexible Power + Brake cable (15m) 4 x 4.0mm <sup>2</sup> + 2 x 1.5mm <sup>2</sup> M23 connector for SGM7A (4.0kW, 5.0kW), SGM7G (4.4kW), SGM7G (3.0kW) High Speed	601 EUR
JZSP-C7M364-20-E-G6	Flexible Power + Brake cable (20m) 4 x 4.0mm <sup>2</sup> + 2 x 1.5mm <sup>2</sup> M23 connector for SGM7A (4.0kW, 5.0kW), SGM7G (4.4kW), SGM7G (3.0kW) High Speed	773 EUR
JZSP-C7M375-03-E-G6	Flexible Power + Brake Cable (3m) 4 x 6.0mm <sup>2</sup> + 2 x 1.5mm <sup>2</sup> with M40 connector for SGM7A (7.0kW), SGM7G (5.5kW-7.5kW), SGM7G-44 High Speed (4.4kW)	281 EUR
JZSP-C7M375-05-E-G6	Flexible Power + Brake Cable (5m) 4 x 6.0mm <sup>2</sup> + 2 x 1.5mm <sup>2</sup> with M40 connector for SGM7A (7.0kW), SGM7G (5.5kW-7.5kW), SGM7G-44 High Speed (4.4kW)	358 EUR
JZSP-C7M375-10-E-G6	Flexible Power + Brake Cable (10m) 4 x 6.0mm <sup>2</sup> + 2 x 1.5mm <sup>2</sup> with M40 connector for SGM7A (7.0kW), SGM7G (5.5kW-7.5kW), SGM7G-44 High Speed (4.4kW)	561 EUR
JZSP-C7M375-15-E-G6	Flexible Power + Brake Cable (15m) 4 x 6.0mm <sup>2</sup> + 2 x 1.5mm <sup>2</sup> with M40 connector for SGM7A (7.0kW), SGM7G (5.5kW-7.5kW), SGM7G-44 High Speed (4.4kW)	773 EUR
JZSP-C7M375-20-E-G6	Flexible Power + Brake Cable (20m) 4 x 6.0mm <sup>2</sup> + 2 x 1.5mm <sup>2</sup> with M40 connector for SGM7A (7.0kW), SGM7G (5.5kW-7.5kW), SGM7G-44 High Speed (4.4kW)	983 EUR



**Incremental Encoder Cable flexible type with straight Connector SGM7A**

Ürün Kodu	Açıklama	Liste Fiyatı
JZSP-C7PI2M-03-E-G6	Flexible Encoder cable (3m) with straight connector M12 for all Sigma-7 400V Motors	136 EUR
JZSP-C7PI2M-05-E-G6	Flexible Encoder cable (5m) with straight connector M12 for all Sigma-7 400V Motors	155 EUR
JZSP-C7PI2M-10-E-G6	Flexible Encoder cable (10m) with straight connector M12 for all Sigma-7 400V Motors	216 EUR
JZSP-C7PI2M-15-E-G6	Flexible Encoder cable (15m) with straight connector M12 for all Sigma-7 400V Motors	282 EUR
JZSP-C7PI2M-20-E-G6	Flexible Encoder cable (20m) with straight connector M12 for all Sigma-7 400V Motors	344 EUR

**Incremental Encoder Cable flexible type with angled Connector SGM7A**

Ürün Kodu	Açıklama	Liste Fiyatı
JZSP-C7PI2N-03-E-G6	Flexible Encoder cable (3m) with angled connector M12 for all Sigma-7 400V Motors	140 EUR
JZSP-C7PI2N-05-E-G6	Flexible Encoder cable (5m) with angled connector M12 for all Sigma-7 400V Motors	155 EUR
JZSP-C7PI2N-10-E-G6	Flexible Encoder cable (10m) with angled connector M12 for all Sigma-7 400V Motors	220 EUR
JZSP-C7PI2N-15-E-G6	Flexible Encoder cable (15m) with angled connector M12 for all Sigma-7 400V Motors	282 EUR
JZSP-C7PI2N-20-E-G6	Flexible Encoder cable (20m) with angled connector M12 for all Sigma-7 400V Motors	348 EUR

**Special Cable for Extension for Absolut Encoder**

Ürün Kodu	Açıklama	Liste Fiyatı
JZSP-CSP12-E-G5	Extension Encoder cable with Connectors length 0.3m for Abs. Encoder, incl. Battery	100 EUR



### Medium Inertia, Low Speed, High Torque Servomotor Sigma 7 Series (SGM7G)

- @ 0.45 - 15 kW
- @ 400V
- @ 1.500 rpm rated speed, up to 3.000 rpm max. speed
- @ 2.86- 95.4Nm rated torque
- @ 8.92- 224Nm peak torque
- @ Optional 24VDC holding brake
- @ Optional Special Oil Seal
- @ CE certified, cULus-listed and RoHS conform
- @ IP67

#### SGM7G Medium Inertia Servo motor with 24-bit Incremental Encoder

Ürün Kodu	Açıklama	Liste Fiyatı
SGM7G-05DFF6F	AC Motor 400V 3ph,0.45kW (2.86Nm rated, 8.92Nm peak), Rated Speed 1500rpm, Maximum Speed 3000rpm, 24bit IncEnc, DustS, shaft end straight with key and tap	714 EUR
SGM7G-09DFFKF	AC Motor 400V 3ph,0.85kW (5.39Nm rated, 13.8Nm peak), Rated Speed 1500rpm, Maximum Speed 3000rpm, 24bit IncEnc, DustS, shaft end straight with key and tap	731 EUR
SGM7G-13DFFKF	AC Motor 400V 3ph,1.30kW (8.34Nm rated, 23.3Nm peak), Rated Speed 1500rpm, Maximum Speed 3000rpm, 24bit IncEnc, DustS, shaft end straight with key and tap	813 EUR
SGM7G-20DFF6F	AC Motor 400V 3ph,1.80kW (11.5Nm rated, 28.7Nm peak), Rated Speed 1500rpm, Maximum Speed 3000rpm, 24bit IncEnc, DustS, shaft end straight with key and tap	1.038 EUR
SGM7G-30DFF6F	AC Motor 400V 3ph,2.90kW (18.6Nm rated, 45.1Nm peak), Rated Speed 1500rpm, Maximum Speed 3000rpm, 24bit IncEnc, DustS, shaft end straight with key and tap	1.495 EUR
SGM7G-44DFF6F	AC Motor 400V 3ph,4.40kW (28.4Nm rated, 71.6Nm peak), Rated Speed 1500rpm, Maximum Speed 3000rpm, 24bit IncEnc, DustS, shaft end straight with key and tap	1.796 EUR
SGM7G-55DFF6F	AC Motor 400V 3ph,5.50kW (35.0Nm rated, 87.6Nm peak), Rated Speed 1500rpm, Maximum Speed 3000rpm, 24bit IncEnc, DustS, shaft end straight with key and tap	2.518 EUR
SGM7G-75DFF6F	AC Motor 400V 3ph,7.50kW (48.0Nm rated, 119Nm peak), Rated Speed 1500rpm, Maximum Speed 3000rpm, 24bit IncEnc, DustS, shaft end straight with key and tap	3.056 EUR
SGM7G-1ADFF6F	AC Motor 400V 3ph,11.0kW (70.0Nm rated, 175Nm peak), Rated Speed 1500rpm, Maximum Speed 2000rpm, 24bit IncEnc, DustS, shaft end straight with key and tap	4.154 EUR
SGM7G-1EDFF6F	AC Motor 400V 3ph,4.40kW (95.4Nm rated, 224Nm peak), Rated Speed 1500rpm, Maximum Speed 2000rpm, 24bit IncEnc, DustS, shaft end straight with key and tap	5.953 EUR

#### SGM7G Medium Inertia Servo motor with 24-bit Incremental Encoder + Brake

Ürün Kodu	Açıklama	Liste Fiyatı
SGM7G-05DFF6H	AC Motor 400V 3ph,0.45kW (2.86Nm rated, 8.92Nm peak), Rated Speed 1500rpm, Maximum Speed 3000rpm, 24bit IncEnc, DustS + Brake, shaft end straight with key and tap	996 EUR
SGM7G-09DFFKH	AC Motor 400V 3ph,0.85kW (5.39Nm rated, 13.8Nm peak), Rated Speed 1500rpm, Maximum Speed 3000rpm, 24bit IncEnc, DustS + Brake, shaft end straight with key and tap	1.029 EUR
SGM7G-13DFFKH	AC Motor 400V 3ph,1.30kW (8.34Nm rated, 23.3Nm peak), Rated Speed 1500rpm, Maximum Speed 3000rpm, 24bit IncEnc, DustS + Brake, shaft end straight with key and tap	1.112 EUR
SGM7G-20DFF6H	AC Motor 400V 3ph,1.80kW (11.5Nm rated, 28.7Nm peak), Rated Speed 1500rpm, Maximum Speed 3000rpm, 24bit IncEnc, DustS + Brake, shaft end straight with key and tap	1.480 EUR
SGM7G-30DFF6H	AC Motor 400V 3ph,2.90kW (18.6Nm rated, 45.1Nm peak), Rated Speed 1500rpm, Maximum Speed 3000rpm, 24bit IncEnc, DustS + Brake, shaft end straight with key and tap	2.255 EUR
SGM7G-44DFF6H	AC Motor 400V 3ph,4.40kW (28.4Nm rated, 71.6Nm peak), Rated Speed 1500rpm, Maximum Speed 3000rpm, 24bit IncEnc, DustS + Brake, shaft end straight with key and tap	2.378 EUR
SGM7G-55DFF6H	AC Motor 400V 3ph,5.50kW (35.0Nm rated, 87.6Nm peak), Rated Speed 1500rpm, Maximum Speed 3000rpm, 24bit IncEnc, DustS + Brake, shaft end straight with key and tap	3.556 EUR
SGM7G-75DFF6H	AC Motor 400V 3ph,7.50kW (48.0Nm rated, 119Nm peak), Rated Speed 1500rpm, Maximum Speed 3000rpm, 24bit IncEnc, DustS + Brake, shaft end straight with key and tap	4.002 EUR
SGM7G-1ADFF6H	AC Motor 400V 3ph,11.0kW (70.0Nm rated, 175Nm peak), Rated Speed 1500rpm, Maximum Speed 2000rpm, 24bit IncEnc, DustS + Brake, shaft end straight with key and tap	5.934 EUR
SGM7G-1EDFF6H	AC Motor 400V 3ph,15.0kW (95.4Nm rated, 224Nm peak), Rated Speed 1500rpm, Maximum Speed 2000rpm, 24bit IncEnc, DustS + Brake, shaft end straight with key and tap	8.134 EUR

**SGM7G Medium Inertia Servo motor with 24-bit Absolut Encoder**

Ürün Kodu	Açıklama	Liste Fiyatı
SGM7G-05D7F6F	AC Motor 400V 3ph,0.45kW (2.86Nm rated, 8.92Nm peak), Rated Speed 1500rpm, Maximum Speed 3000rpm, 24bit AbsEnc, DustS, shaft end straight with key and tap	992 EUR
SGM7G-09D7FKF	AC Motor 400V 3ph,0.85kW (5.39Nm rated, 13.8Nm peak), Rated Speed 1500rpm, Maximum Speed 3000rpm, 24bit AbsEnc, DustS, shaft end straight with key and tap	1.012 EUR
SGM7G-13D7FKF	AC Motor 400V 3ph,1.30kW (8.34Nm rated, 23.3Nm peak), Rated Speed 1500rpm, Maximum Speed 3000rpm, 24bit AbsEnc, DustS, shaft end straight with key and tap	1.109 EUR
SGM7G-20D7F6F	AC Motor 400V 3ph,1.80kW (11.5Nm rated, 28.7Nm peak), Rated Speed 1500rpm, Maximum Speed 3000rpm, 24bit AbsEnc, DustS, shaft end straight with key and tap	1.275 EUR
SGM7G-30D7F6F	AC Motor 400V 3ph,2.90kW (18.6Nm rated, 45.1Nm peak), Rated Speed 1500rpm, Maximum Speed 3000rpm, 24bit AbsEnc, DustS, shaft end straight with key and tap	1.705 EUR
SGM7G-44D7F6F	AC Motor 400V 3ph,4.40kW (28.4Nm rated, 71.6Nm peak), Rated Speed 1500rpm, Maximum Speed 3000rpm, 24bit AbsEnc, DustS, shaft end straight with key and tap	2.006 EUR
SGM7G-55D7F6F	AC Motor 400V 3ph,5.50kW (35.0Nm rated, 87.6Nm peak), Rated Speed 1500rpm, Maximum Speed 3000rpm, 24bit AbsEnc, DustS, shaft end straight with key and tap	2.700 EUR
SGM7G-75D7F6F	AC Motor 400V 3ph,7.50kW (48.0Nm rated, 119Nm peak), Rated Speed 1500rpm, Maximum Speed 3000rpm, 24bit AbsEnc, DustS, shaft end straight with key and tap	3.185 EUR
SGM7G-1AD7F6F	AC Motor 400V 3ph,11.0kW (70.0Nm rated, 175Nm peak), Rated Speed 1500rpm, Maximum Speed 2000rpm, 24bit AbsEnc, DustS, shaft end straight with key and tap	4.302 EUR
SGM7G-1ED7F6F	AC Motor 400V 3ph,15.0kW (95.4Nm rated, 224Nm peak), Rated Speed 1500rpm, Maximum Speed 2000rpm, 24bit AbsEnc, DustS, shaft end straight with key and tap	6.094 EUR

**SGM7G Medium Inertia Servo motor with 24-bit Absolut Encoder + Brake**

Ürün Kodu	Açıklama	Liste Fiyatı
SGM7G-05D7F6H	AC Motor 400V 3ph,0.45kW (2.86Nm rated, 8.92Nm peak), Rated Speed 1500rpm, Maximum Speed 3000rpm, 24bit AbsEnc, DustS + Brake, shaft end straight with key and tap	1.330 EUR
SGM7G-09D7FKH	AC Motor 400V 3ph,0.85kW (5.39Nm rated, 13.8Nm peak), Rated Speed 1500rpm, Maximum Speed 3000rpm, 24bit AbsEnc, DustS + Brake, shaft end straight with key and tap	1.367 EUR
SGM7G-13D7FKH	AC Motor 400V 3ph,1.30kW (8.34Nm rated, 23.3Nm peak), Rated Speed 1500rpm, Maximum Speed 3000rpm, 24bit AbsEnc, DustS + Brake, shaft end straight with key and tap	1.470 EUR
SGM7G-20D7F6H	AC Motor 400V 3ph,1.80kW (11.5Nm rated, 28.7Nm peak), Rated Speed 1500rpm, Maximum Speed 3000rpm, 24bit AbsEnc, DustS + Brake, shaft end straight with key and tap	1.634 EUR
SGM7G-30D7F6H	AC Motor 400V 3ph,2.90kW (18.6Nm rated, 45.1Nm peak), Rated Speed 1500rpm, Maximum Speed 3000rpm, 24bit AbsEnc, DustS + Brake, shaft end straight with key and tap	2.855 EUR
SGM7G-44D7F6H	AC Motor 400V 3ph,4.40kW (28.4Nm rated, 71.6Nm peak), Rated Speed 1500rpm, Maximum Speed 3000rpm, 24bit AbsEnc, DustS + Brake, shaft end straight with key and tap	2.988 EUR
SGM7G-55D7F6H	AC Motor 400V 3ph,5.50kW (35.0Nm rated, 87.6Nm peak), Rated Speed 1500rpm, Maximum Speed 3000rpm, 24bit AbsEnc, DustS + Brake, shaft end straight with key and tap	3.698 EUR
SGM7G-75D7F6H	AC Motor 400V 3ph,7.50kW (48.0Nm rated, 119Nm peak), Rated Speed 1500rpm, Maximum Speed 3000rpm, 24bit AbsEnc, DustS + Brake, shaft end straight with key and tap	4.088 EUR
SGM7G-1AD7F6H	AC Motor 400V 3ph,11.0kW (70.0Nm rated, 175Nm peak), Rated Speed 1500rpm, Maximum Speed 2000rpm, 24bit AbsEnc, DustS + Brake, shaft end straight with key and tap	6.076 EUR
SGM7G-1ED7F6H	AC Motor 400V 3ph,15.0kW (95.4Nm rated, 224Nm peak), Rated Speed 1500rpm, Maximum Speed 2000rpm, 24bit AbsEnc, DustS + Brake, shaft end straight with key and tap	8.274 EUR

Servo Motor Power Cable flexible type SGM7G

Ürün Kodu	Açıklama	Liste Fiyatı
JZSP-C7M144-03-E-G6	Flexible Power cable (3m) 4 x 1.5mm <sup>2</sup> with M23 connector for SGM7J (1.5kW), SGM7A (1.0-2.5kW), SGM7G (0.5kW-2.0kW), SGM7G (0.5 to 0.9kW) High Speed, SGLFW2-45A200	105 EUR
JZSP-C7M144-05-E-G6	Flexible Power cable (5m) 4 x 1.5mm <sup>2</sup> with M23 connector for SGM7J (1.5kW), SGM7A (1.0-2.5kW), SGM7G (0.5kW-2.0kW), SGM7G (0.5 to 0.9kW) High Speed, SGLFW2-45A200	124 EUR
JZSP-C7M144-10-E-G6	Flexible Power cable (10m) 4 x 1.5mm <sup>2</sup> with M23 connector for SGM7J (1.5kW), SGM7A (1.0-2.5kW), SGM7G (0.5kW-2.0kW), SGM7G (0.5 to 0.9kW) High Speed, SGLFW2-45A200	183 EUR
JZSP-C7M144-15-E-G6	Flexible Power cable (15m) 4 x 1.5mm <sup>2</sup> with M23 connector for SGM7J (1.5kW), SGM7A (1.0-2.5kW), SGM7G (0.5kW-2.0kW), SGM7G (0.5 to 0.9kW) High Speed, SGLFW2-45A200	253 EUR
JZSP-C7M144-20-E-G6	Flexible Power cable (20m) 4 x 1.5mm <sup>2</sup> with M23 connector for SGM7J (1.5kW), SGM7A (1.0-2.5kW), SGM7G (0.5kW-2.0kW), SGM7G (0.5 to 0.9kW) High Speed, SGLFW2-45A200	313 EUR
JZSP-C7M154-03-E-G6	Flexible Power cable (3m) 4 x 2.5mm <sup>2</sup> with M23 connector for SGM7A (3.0kW), SGM7G (3.0kW), SGM7G (1.3 to 2.0kW) High Speed, SGLFW2-90D200 to SGLFW2-1DD380, SGLFW2-45A380 to SGLFW2-90A200	127 EUR
JZSP-C7M154-05-E-G6	Flexible Power cable (5m) 4 x 2.5mm <sup>2</sup> with M23 connector for SGM7A (3.0kW), SGM7G (3.0kW), SGM7G (1.3 to 2.0kW) High Speed, SGLFW2-90D200 to SGLFW2-1DD380, SGLFW2-45A380 to SGLFW2-90A200	162 EUR
JZSP-C7M154-10-E-G6	Flexible Power cable (10m) 4 x 2.5mm <sup>2</sup> with M23 connector for SGM7A (3.0kW), SGM7G (3.0kW), SGM7G (1.3 to 2.0kW) High Speed, SGLFW2-90D200 to SGLFW2-1DD380, SGLFW2-45A380 to SGLFW2-90A200	256 EUR
JZSP-C7M154-15-E-G6	Flexible Power cable (15m) 4 x 2.5mm <sup>2</sup> with M23 connector for SGM7A (3.0kW), SGM7G (3.0kW), SGM7G (1.3 to 2.0kW) High Speed, SGLFW2-90D200 to SGLFW2-1DD380, SGLFW2-45A380 to SGLFW2-90A200	362 EUR
JZSP-C7M154-20-E-G6	Flexible Power cable (20m) 4 x 2.5mm <sup>2</sup> with M23 connector for SGM7A (3.0kW), SGM7G (3.0kW), SGM7G (1.3 to 2.0kW) High Speed, SGLFW2-90D200 to SGLFW2-1DD380, SGLFW2-45A380 to SGLFW2-90A200	460 EUR
JZSP-C7M164-03-E-G6	Flexible Power cable (3m) 4 x 4.0mm <sup>2</sup> with M23 connector for SGM7A (4.0kW, 5.0kW), SGM7G (4.4kW), SGM7G (3.0kW) High Speed, SGLFW2-1DD560, SGLFW2-90A380 to SGLFW2-90A560	141 EUR
JZSP-C7M164-05-E-G6	Flexible Power cable (5m) 4 x 4.0mm <sup>2</sup> with M23 connector for SGM7A (4.0kW, 5.0kW), SGM7G (4.4kW), SGM7G (3.0kW) High Speed, SGLFW2-1DD560, SGLFW2-90A380 to SGLFW2-90A560	183 EUR
JZSP-C7M164-10-E-G6	Flexible Power cable (10m) 4 x 4.0mm <sup>2</sup> with M23 connector for SGM7A (4.0kW, 5.0kW), SGM7G (4.4kW), SGM7G (3.0kW) High Speed, SGLFW2-1DD560, SGLFW2-90A380 to SGLFW2-90A560	298 EUR
JZSP-C7M164-15-E-G6	Flexible Power cable (15m) 4 x 4.0mm <sup>2</sup> with M23 connector for SGM7A (4.0kW, 5.0kW), SGM7G (4.4kW), SGM7G (3.0kW) High Speed, SGLFW2-1DD560, SGLFW2-90A380 to SGLFW2-90A560	425 EUR
JZSP-C7M164-20-E-G6	Flexible Power cable (20m) 4 x 4.0mm <sup>2</sup> with M23 connector for SGM7A (4.0kW, 5.0kW), SGM7G (4.4kW), SGM7G (3.0kW) High Speed, SGLFW2-1DD560, SGLFW2-90A380 to SGLFW2-90A560	537 EUR
JZSP-C7M175-03-E-G6	Flexible Power Cable (3m) 4 x 6.0mm <sup>2</sup> with M40 connector for SGM7A (7.0kW), SGM7G (5.5kW-7.5kW), SGM7G-44 High Speed (4.4kW)	250 EUR
JZSP-C7M175-05-E-G6	Flexible Power Cable (5m) 4 x 6.0mm <sup>2</sup> with M40 connector for SGM7A (7.0kW), SGM7G (5.5kW-7.5kW), SGM7G-44 High Speed (4.4kW)	313 EUR
JZSP-C7M175-10-E-G6	Flexible Power Cable (10m) 4 x 6.0mm <sup>2</sup> with M40 connector for SGM7A (7.0kW), SGM7G (5.5kW-7.5kW), SGM7G-44 High Speed (4.4kW)	477 EUR
JZSP-C7M175-15-E-G6	Flexible Power Cable (15m) 4 x 6.0mm <sup>2</sup> with M40 connector for SGM7A (7.0kW), SGM7G (5.5kW-7.5kW), SGM7G-44 High Speed (4.4kW)	671 EUR
JZSP-C7M175-20-E-G6	Flexible Power Cable (20m) 4 x 6.0mm <sup>2</sup> with M40 connector for SGM7A (7.0kW), SGM7G (5.5kW-7.5kW), SGM7G-44 High Speed (4.4kW)	847 EUR
JZSP-C7M185-03-E-G6	Flexible Power Cable (3m) 4 x 10.0mm <sup>2</sup> with M40 connector for SGM7G (11kW-15kW)	298 EUR
JZSP-C7M185-05-E-G6	Flexible Power Cable (5m) 4 x 10.0mm <sup>2</sup> with M40 connector for SGM7G (11kW-15kW)	389 EUR
JZSP-C7M185-10-E-G6	Flexible Power Cable (10m) 4 x 10.0mm <sup>2</sup> with M40 connector for SGM7G (11kW-15kW)	632 EUR
JZSP-C7M185-15-E-G6	Flexible Power Cable (15m) 4 x 10.0mm <sup>2</sup> with M40 connector for SGM7G (11kW-15kW)	895 EUR
JZSP-C7M185-20-E-G6	Flexible Power Cable (20m) 4 x 10.0mm <sup>2</sup> with M40 connector for SGM7G (11kW-15kW)	1.145 EUR

Servo Motor Power Cable flexible type for Motors with Brake SGM7G

Ürün Kodu	Açıklama	Liste Fiyatı
JZSP-C7M344-03-E-G6	Flexible Power + Brake cable (3m) 4 x 1.5mm <sup>2</sup> + 2 x 1.5mm <sup>2</sup> M23 connector for SGM7J (1.5kW), SGM7A (1.0-2.5kW), SGM7G (0.5kW-2.0kW), SGM7G-05 to -09 High Speed	124 EUR
JZSP-C7M344-05-E-G6	Flexible Power + Brake cable (5m) 4 x 1.5mm <sup>2</sup> + 2 x 1.5mm <sup>2</sup> M23 connector for SGM7J (1.5kW), SGM7A (1.0-2.5kW), SGM7G (0.5kW-2.0kW), SGM7G-05 to -09 High Speed	155 EUR
JZSP-C7M344-10-E-G6	Flexible Power + Brake cable (10m) 4 x 1.5mm <sup>2</sup> + 2 x 1.5mm <sup>2</sup> M23 connector for SGM7J (1.5kW), SGM7A (1.0-2.5kW), SGM7G (0.5kW-2.0kW), SGM7G-05 to -09 High Speed	243 EUR
JZSP-C7M344-15-E-G6	Flexible Power + Brake cable (15m) 4 x 1.5mm <sup>2</sup> + 2 x 1.5mm <sup>2</sup> M23 connector for SGM7J (1.5kW), SGM7A (1.0-2.5kW), SGM7G (0.5kW-2.0kW), SGM7G-05 to -09 High Speed	348 EUR
JZSP-C7M344-20-E-G6	Flexible Power + Brake cable (20m) 4 x 1.5mm <sup>2</sup> + 2 x 1.5mm <sup>2</sup> M23 connector for SGM7J (1.5kW), SGM7A (1.0-2.5kW), SGM7G (0.5kW-2.0kW), SGM7G-05 to -09 High Speed	440 EUR
JZSP-C7M354-03-E-G6	Flexible Power + Brake cable (3m) 4 x 2.5mm <sup>2</sup> + 2 x 1.5mm <sup>2</sup> M23 connector for SGM7A (3.0kW), SGM7G (3.0kW), SGM7G (1.3 to 2.0kW) High Speed	143 EUR
JZSP-C7M354-05-E-G6	Flexible Power + Brake cable (5m) 4 x 2.5mm <sup>2</sup> + 2 x 1.5mm <sup>2</sup> M23 connector for SGM7A (3.0kW), SGM7G (3.0kW), SGM7G (1.3 to 2.0kW) High Speed	189 EUR
JZSP-C7M354-10-E-G6	Flexible Power + Brake cable (10m) 4 x 2.5mm <sup>2</sup> + 2 x 1.5mm <sup>2</sup> M23 connector for SGM7A (3.0kW), SGM7G (3.0kW), SGM7G (1.3 to 2.0kW) High Speed	313 EUR
JZSP-C7M354-15-E-G6	Flexible Power + Brake cable (15m) 4 x 2.5mm <sup>2</sup> + 2 x 1.5mm <sup>2</sup> M23 connector for SGM7A (3.0kW), SGM7G (3.0kW), SGM7G (1.3 to 2.0kW) High Speed	451 EUR
JZSP-C7M354-20-E-G6	Flexible Power + Brake cable (20m) 4 x 2.5mm <sup>2</sup> + 2 x 1.5mm <sup>2</sup> M23 connector for SGM7A (3.0kW), SGM7G (3.0kW), SGM7G (1.3 to 2.0kW) High Speed	575 EUR
JZSP-C7M364-03-E-G6	Flexible Power + Brake cable (3m) 4 x 4.0mm <sup>2</sup> + 2 x 1.5mm <sup>2</sup> M23 connector for SGM7A (4.0kW, 5.0kW), SGM7G (4.4kW), SGM7G (3.0kW) High Speed	179 EUR
JZSP-C7M364-05-E-G6	Flexible Power + Brake cable (5m) 4 x 4.0mm <sup>2</sup> + 2 x 1.5mm <sup>2</sup> M23 connector for SGM7A (4.0kW, 5.0kW), SGM7G (4.4kW), SGM7G (3.0kW) High Speed	246 EUR
JZSP-C7M364-10-E-G6	Flexible Power + Brake cable (10m) 4 x 4.0mm <sup>2</sup> + 2 x 1.5mm <sup>2</sup> M23 connector for SGM7A (4.0kW, 5.0kW), SGM7G (4.4kW), SGM7G (3.0kW) High Speed	415 EUR
JZSP-C7M364-15-E-G6	Flexible Power + Brake cable (15m) 4 x 4.0mm <sup>2</sup> + 2 x 1.5mm <sup>2</sup> M23 connector for SGM7A (4.0kW, 5.0kW), SGM7G (4.4kW), SGM7G (3.0kW) High Speed	601 EUR
JZSP-C7M364-20-E-G6	Flexible Power + Brake cable (20m) 4 x 4.0mm <sup>2</sup> + 2 x 1.5mm <sup>2</sup> M23 connector for SGM7A (4.0kW, 5.0kW), SGM7G (4.4kW), SGM7G (3.0kW) High Speed	773 EUR
JZSP-C7M375-03-E-G6	Flexible Power + Brake Cable (3m) 4 x 6.0mm <sup>2</sup> + 2 x 1.5mm <sup>2</sup> with M40 connector for SGM7A (7.0kW), SGM7G (5.5kW-7.5kW), SGM7G-44 High Speed (4.4kW)	281 EUR
JZSP-C7M375-05-E-G6	Flexible Power + Brake Cable (5m) 4 x 6.0mm <sup>2</sup> + 2 x 1.5mm <sup>2</sup> with M40 connector for SGM7A (7.0kW), SGM7G (5.5kW-7.5kW), SGM7G-44 High Speed (4.4kW)	358 EUR
JZSP-C7M375-10-E-G6	Flexible Power + Brake Cable (10m) 4 x 6.0mm <sup>2</sup> + 2 x 1.5mm <sup>2</sup> with M40 connector for SGM7A (7.0kW), SGM7G (5.5kW-7.5kW), SGM7G-44 High Speed (4.4kW)	561 EUR
JZSP-C7M375-15-E-G6	Flexible Power + Brake Cable (15m) 4 x 6.0mm <sup>2</sup> + 2 x 1.5mm <sup>2</sup> with M40 connector for SGM7A (7.0kW), SGM7G (5.5kW-7.5kW), SGM7G-44 High Speed (4.4kW)	773 EUR
JZSP-C7M375-20-E-G6	Flexible Power + Brake Cable (20m) 4 x 6.0mm <sup>2</sup> + 2 x 1.5mm <sup>2</sup> with M40 connector for SGM7A (7.0kW), SGM7G (5.5kW-7.5kW), SGM7G-44 High Speed (4.4kW)	983 EUR
JZSP-C7M385-03-E-G6	Flexible Power + Brake Cable (3m) 4 x 10.0mm <sup>2</sup> + 2 x 1.5mm <sup>2</sup> with M40 connector for SGM7G (11kW-15kW)	334 EUR
JZSP-C7M385-05-E-G6	Flexible Power + Brake Cable (5m) 4 x 10.0mm <sup>2</sup> + 2 x 1.5mm <sup>2</sup> with M40 connector for SGM7G (11kW-15kW)	442 EUR
JZSP-C7M385-10-E-G6	Flexible Power + Brake Cable (10m) 4 x 10.0mm <sup>2</sup> + 2 x 1.5mm <sup>2</sup> with M40 connector for SGM7G (11kW-15kW)	723 EUR
JZSP-C7M385-15-E-G6	Flexible Power + Brake Cable (15m) 4 x 10.0mm <sup>2</sup> + 2 x 1.5mm <sup>2</sup> with M40 connector for SGM7G (11kW-15kW)	1.019 EUR
JZSP-C7M385-20-E-G6	Flexible Power + Brake Cable (20m) 4 x 10.0mm <sup>2</sup> + 2 x 1.5mm <sup>2</sup> with M40 connector for SGM7G (11kW-15kW)	1.303 EUR

**Incremental Encoder Cable flexible type with straight Connector SGM7G**

Ürün Kodu	Açıklama	Liste Fiyatı
JZSP-C7PI2M-03-E-G6	Flexible Encoder cable (3m) with straight connector M12 for all Sigma-7 400V Motors	136 EUR
JZSP-C7PI2M-05-E-G6	Flexible Encoder cable (5m) with straight connector M12 for all Sigma-7 400V Motors	155 EUR
JZSP-C7PI2M-10-E-G6	Flexible Encoder cable (10m) with straight connector M12 for all Sigma-7 400V Motors	216 EUR
JZSP-C7PI2M-15-E-G6	Flexible Encoder cable (15m) with straight connector M12 for all Sigma-7 400V Motors	282 EUR
JZSP-C7PI2M-20-E-G6	Flexible Encoder cable (20m) with straight connector M12 for all Sigma-7 400V Motors	344 EUR

**Incremental Encoder Cable flexible type with angled Connector SGM7G**

Ürün Kodu	Açıklama	Liste Fiyatı
JZSP-C7PI2N-03-E-G6	Flexible Encoder cable (3m) with angled connector M12 for all Sigma-7 400V Motors	140 EUR
JZSP-C7PI2N-05-E-G6	Flexible Encoder cable (5m) with angled connector M12 for all Sigma-7 400V Motors	155 EUR
JZSP-C7PI2N-10-E-G6	Flexible Encoder cable (10m) with angled connector M12 for all Sigma-7 400V Motors	220 EUR
JZSP-C7PI2N-15-E-G6	Flexible Encoder cable (15m) with angled connector M12 for all Sigma-7 400V Motors	282 EUR
JZSP-C7PI2N-20-E-G6	Flexible Encoder cable (20m) with angled connector M12 for all Sigma-7 400V Motors	348 EUR

**Special Cable for Extension for Absolut Encoder**

Ürün Kodu	Açıklama	Liste Fiyatı
JZSP-CSP12-E-G5	Extension Encoder cable with Connectors length 0.3m for Abs. Encoder, incl. Battery	100 EUR



### Medium Inertia, High Speed, High Torque Servomotor Sigma 7 Series (SGM7G)

- @ 0.45 - 4.4 kW
- @ 400V
- @ 1.500 rpm rated speed, Allowable Continuous Speed up to 5000rpm,
- @ up to 5.000 rpm max. speed
- @ 2.86- 28.4Nm rated torque
- @ 8.8- 71.1Nm rated torque
- @ Optional 24VDC holding brake
- @ Optional Special Oil Seal (on request)
- @ CE certified, cULus-listed and RoHS conform
- @ IP67

#### SGM7G Medium Inertia High Speed Servo motor with 24-bit Incremental Encoder

Ürün Kodu	Açıklama	Liste Fiyatı
SGM7G-05DFR6F	High Speed AC Motor 400V 3ph,0.45kW (2.86Nm rated, 8.8Nm peak), Rated Speed 1500rpm, Maximum Speed 5000rpm, Allowable Continuous Speed 5000rpm, 24bit IncEnc, DustS	1.075 EUR
SGM7G-09DFRKF	High Speed AC Motor 400V 3ph,0.85kW (5.39Nm rated, 15.0Nm peak), Rated Speed 1500rpm, Maximum Speed 5000rpm, Allowable Continuous Speed 4000rpm, 24bit IncEnc, DustS	1.128 EUR
SGM7G-13DFRKF	High Speed AC Motor 400V 3ph,1.30kW (8.34Nm rated, 22.0Nm peak), Rated Speed 1500rpm, Maximum Speed 5000rpm, Allowable Continuous Speed 4000rpm, 24bit IncEnc, DustS	1.280 EUR
SGM7G-20DFR6F	High Speed AC Motor 400V 3ph,1.80kW (11.5Nm rated, 28.7Nm peak), Rated Speed 1500rpm, Maximum Speed 5000rpm, Allowable Continuous Speed 4000rpm, 24bit IncEnc, DustS	1.537 EUR
SGM7G-30DFR6F	High Speed AC Motor 400V 3ph,2.90kW (18.6Nm rated, 50.0Nm peak), Rated Speed 1500rpm, Maximum Speed 4500rpm, Allowable Continuous Speed 3300rpm, 24bit IncEnc, DustS	2.019 EUR
SGM7G-44DFR6F	High Speed AC Motor 400V 3ph,4.40kW (28.4Nm rated, 71.1Nm peak), Rated Speed 1500rpm, Maximum Speed 4500rpm, Allowable Continuous Speed 3000rpm, 24bit IncEnc, DustS	2.964 EUR

#### SGM7G Medium Inertia High Speed Servo motor with 24-bit Incremental Encoder + Brake

Ürün Kodu	Açıklama	Liste Fiyatı
SGM7G-05DFR6H	High Speed AC Motor 400V 3ph,0.45kW (2.86Nm rated, 8.8Nm peak), Rated Speed 1500rpm, Maximum Speed 5000rpm, Allowable Continuous Speed 5000rpm, 24bit IncEnc, DustS + brake	1.150 EUR
SGM7G-09DFRKH	High Speed AC Motor 400V 3ph,0.85kW (5.39Nm rated, 15.0Nm peak), Rated Speed 1500rpm, Maximum Speed 5000rpm, Allowable Continuous Speed 4000rpm, 24bit IncEnc, DustS + brake	1.431 EUR
SGM7G-13DFRKH	High Speed AC Motor 400V 3ph,1.30kW (8.34Nm rated, 22.0Nm peak), Rated Speed 1500rpm, Maximum Speed 5000rpm, Allowable Continuous Speed 4000rpm, 24bit IncEnc, DustS + brake	1.873 EUR
SGM7G-20DFR6H	High Speed AC Motor 400V 3ph,1.80kW (11.5Nm rated, 28.7Nm peak), Rated Speed 1500rpm, Maximum Speed 5000rpm, Allowable Continuous Speed 4000rpm, 24bit IncEnc, DustS + brake	2.132 EUR
SGM7G-30DFR6H	High Speed AC Motor 400V 3ph,2.90kW (18.6Nm rated, 50.0Nm peak), Rated Speed 1500rpm, Maximum Speed 4500rpm, Allowable Continuous Speed 3300rpm, 24bit IncEnc, DustS + brake	2.435 EUR
SGM7G-44DFR6H	High Speed AC Motor 400V 3ph,4.40kW (28.4Nm rated, 71.1Nm peak), Rated Speed 1500rpm, Maximum Speed 4500rpm, Allowable Continuous Speed 3000rpm, 24bit IncEnc, DustS + brake	3.151 EUR

#### SGM7G Medium Inertia High Speed Servo motor with 24-bit Absolute Encoder

Ürün Kodu	Açıklama	Liste Fiyatı
SGM7G-05D7R6F	High Speed AC Motor 400V 3ph,0.45kW (2.86Nm rated, 8.8Nm peak), Rated Speed 1500rpm, Maximum Speed 5000rpm, Allowable Continuous Speed 5000rpm, 24bit AbsEnc, DustS	1.275 EUR
SGM7G-09D7RKF	High Speed AC Motor 400V 3ph,0.85kW (5.39Nm rated, 15.0Nm peak), Rated Speed 1500rpm, Maximum Speed 5000rpm, Allowable Continuous Speed 4000rpm, 24bit AbsEnc, DustS	1.548 EUR
SGM7G-13D7RKF	High Speed AC Motor 400V 3ph,1.30kW (8.34Nm rated, 22.0Nm peak), Rated Speed 1500rpm, Maximum Speed 5000rpm, Allowable Continuous Speed 4000rpm, 24bit AbsEnc, DustS	1.730 EUR
SGM7G-20D7R6F	High Speed AC Motor 400V 3ph,1.80kW (11.5Nm rated, 28.7Nm peak), Rated Speed 1500rpm, Maximum Speed 5000rpm, Allowable Continuous Speed 4000rpm, 24bit AbsEnc, DustS	1.736 EUR
SGM7G-30D7R6F	High Speed AC Motor 400V 3ph,2.90kW (18.6Nm rated, 50.0Nm peak), Rated Speed 1500rpm, Maximum Speed 4500rpm, Allowable Continuous Speed 3300rpm, 24bit AbsEnc, DustS	2.219 EUR
SGM7G-44D7R6F	High Speed AC Motor 400V 3ph,4.40kW (28.4Nm rated, 71.1Nm peak), Rated Speed 1500rpm, Maximum Speed 4500rpm, Allowable Continuous Speed 3000rpm, 24bit AbsEnc, DustS	3.168 EUR

**SGM7G Medium Inertia High Speed Servo motor with 24-bit Absolute Encoder+ brake**

Ürün Kodu	Açıklama	Liste Fiyatı
SGM7G-05D7R6H	High Speed AC Motor 400V 3ph,0.45kW (2.86Nm rated, 8.8Nm peak), Rated Speed 1500rpm, Maximum Speed 5000rpm, Allowable Continuous Speed 5000rpm, 24bit AbsEnc, DustS + brake	1.681 EUR
SGM7G-09D7RKH	High Speed AC Motor 400V 3ph,0.85kW (5.39Nm rated, 15.0Nm peak), Rated Speed 1500rpm, Maximum Speed 5000rpm, Allowable Continuous Speed 4000rpm, 24bit AbsEnc, DustS + brake	2.060 EUR
SGM7G-13D7RKH	High Speed AC Motor 400V 3ph,1.30kW (8.34Nm rated, 22.0Nm peak), Rated Speed 1500rpm, Maximum Speed 5000rpm, Allowable Continuous Speed 4000rpm, 24bit AbsEnc, DustS + brake	2.621 EUR
SGM7G-20D7R6H	High Speed AC Motor 400V 3ph,1.80kW (11.5Nm rated, 28.7Nm peak), Rated Speed 1500rpm, Maximum Speed 5000rpm, Allowable Continuous Speed 4000rpm, 24bit AbsEnc, DustS + brake	2.956 EUR
SGM7G-30D7R6H	High Speed AC Motor 400V 3ph,2.90kW (18.6Nm rated, 50.0Nm peak), Rated Speed 1500rpm, Maximum Speed 4500rpm, Allowable Continuous Speed 3300rpm, 24bit AbsEnc, DustS + brake	3.366 EUR
SGM7G-44D7R6H	High Speed AC Motor 400V 3ph,4.40kW (28.4Nm rated, 71.1Nm peak), Rated Speed 1500rpm, Maximum Speed 4500rpm, Allowable Continuous Speed 3000rpm, 24bit AbsEnc, DustS + brake	4.286 EUR

**Servo Motor Power Cable flexible type SGM7G**

Ürün Kodu	Açıklama	Liste Fiyatı
JZSP-C7M144-03-E-G6	Flexible Power cable (3m) 4 x 1.5mm <sup>2</sup> with M23 connector for SGM7J (1.5kW), SGM7A (1.0-2.5kW), SGM7G (0.5kW-2.0kW), SGM7G (0.5 to 0.9kW) High Speed, SGLFW2-45A200	105 EUR
JZSP-C7M144-05-E-G6	Flexible Power cable (5m) 4 x 1.5mm <sup>2</sup> with M23 connector for SGM7J (1.5kW), SGM7A (1.0-2.5kW), SGM7G (0.5kW-2.0kW), SGM7G (0.5 to 0.9kW) High Speed, SGLFW2-45A200	124 EUR
JZSP-C7M144-10-E-G6	Flexible Power cable (10m) 4 x 1.5mm <sup>2</sup> with M23 connector for SGM7J (1.5kW), SGM7A (1.0-2.5kW), SGM7G (0.5kW-2.0kW), SGM7G (0.5 to 0.9kW) High Speed, SGLFW2-45A200	183 EUR
JZSP-C7M144-15-E-G6	Flexible Power cable (15m) 4 x 1.5mm <sup>2</sup> with M23 connector for SGM7J (1.5kW), SGM7A (1.0-2.5kW), SGM7G (0.5kW-2.0kW), SGM7G (0.5 to 0.9kW) High Speed, SGLFW2-45A200	253 EUR
JZSP-C7M144-20-E-G6	Flexible Power cable (20m) 4 x 1.5mm <sup>2</sup> with M23 connector for SGM7J (1.5kW), SGM7A (1.0-2.5kW), SGM7G (0.5kW-2.0kW), SGM7G (0.5 to 0.9kW) High Speed, SGLFW2-45A200	313 EUR
JZSP-C7M154-03-E-G6	Flexible Power cable (3m) 4 x 2.5mm <sup>2</sup> with M23 connector for SGM7A (3.0kW), SGM7G (3.0kW), SGM7G (1.3 to 2.0kW) High Speed, SGLFW2-90D200 to SGLFW2-1DD380, SGLFW2-45A380 to SGLFW2-90A200	127 EUR
JZSP-C7M154-05-E-G6	Flexible Power cable (5m) 4 x 2.5mm <sup>2</sup> with M23 connector for SGM7A (3.0kW), SGM7G (3.0kW), SGM7G (1.3 to 2.0kW) High Speed, SGLFW2-90D200 to SGLFW2-1DD380, SGLFW2-45A380 to SGLFW2-90A200	162 EUR
JZSP-C7M154-10-E-G6	Flexible Power cable (10m) 4 x 2.5mm <sup>2</sup> with M23 connector for SGM7A (3.0kW), SGM7G (3.0kW), SGM7G (1.3 to 2.0kW) High Speed, SGLFW2-90D200 to SGLFW2-1DD380, SGLFW2-45A380 to SGLFW2-90A200	256 EUR
JZSP-C7M154-15-E-G6	Flexible Power cable (15m) 4 x 2.5mm <sup>2</sup> with M23 connector for SGM7A (3.0kW), SGM7G (3.0kW), SGM7G (1.3 to 2.0kW) High Speed, SGLFW2-90D200 to SGLFW2-1DD380, SGLFW2-45A380 to SGLFW2-90A200	362 EUR
JZSP-C7M154-20-E-G6	Flexible Power cable (20m) 4 x 2.5mm <sup>2</sup> with M23 connector for SGM7A (3.0kW), SGM7G (3.0kW), SGM7G (1.3 to 2.0kW) High Speed, SGLFW2-90D200 to SGLFW2-1DD380, SGLFW2-45A380 to SGLFW2-90A200	460 EUR
JZSP-C7M164-03-E-G6	Flexible Power cable (3m) 4 x 4.0mm <sup>2</sup> with M23 connector for SGM7A (4.0kW, 5.0kW), SGM7G (4.4kW), SGM7G (3.0kW) High Speed, SGLFW2-1DD560, SGLFW2-90A380 to SGLFW2-90A560	141 EUR
JZSP-C7M164-05-E-G6	Flexible Power cable (5m) 4 x 4.0mm <sup>2</sup> with M23 connector for SGM7A (4.0kW, 5.0kW), SGM7G (4.4kW), SGM7G (3.0kW) High Speed, SGLFW2-1DD560, SGLFW2-90A380 to SGLFW2-90A560	183 EUR
JZSP-C7M164-10-E-G6	Flexible Power cable (10m) 4 x 4.0mm <sup>2</sup> with M23 connector for SGM7A (4.0kW, 5.0kW), SGM7G (4.4kW), SGM7G (3.0kW) High Speed, SGLFW2-1DD560, SGLFW2-90A380 to SGLFW2-90A560	298 EUR
JZSP-C7M164-15-E-G6	Flexible Power cable (15m) 4 x 4.0mm <sup>2</sup> with M23 connector for SGM7A (4.0kW, 5.0kW), SGM7G (4.4kW), SGM7G (3.0kW) High Speed, SGLFW2-1DD560, SGLFW2-90A380 to SGLFW2-90A560	425 EUR
JZSP-C7M164-20-E-G6	Flexible Power cable (20m) 4 x 4.0mm <sup>2</sup> with M23 connector for SGM7A (4.0kW, 5.0kW), SGM7G (4.4kW), SGM7G (3.0kW) High Speed, SGLFW2-1DD560, SGLFW2-90A380 to SGLFW2-90A560	537 EUR
JZSP-C7M175-03-E-G6	Flexible Power Cable (3m) 4 x 6.0mm <sup>2</sup> with M40 connector for SGM7A (7.0kW), SGM7G (5.5kW-7.5kW), SGM7G-44 High Speed (4.4kW)	250 EUR
JZSP-C7M175-05-E-G6	Flexible Power Cable (5m) 4 x 6.0mm <sup>2</sup> with M40 connector for SGM7A (7.0kW), SGM7G (5.5kW-7.5kW), SGM7G-44 High Speed (4.4kW)	313 EUR
JZSP-C7M175-10-E-G6	Flexible Power Cable (10m) 4 x 6.0mm <sup>2</sup> with M40 connector for SGM7A (7.0kW), SGM7G (5.5kW-7.5kW), SGM7G-44 High Speed (4.4kW)	477 EUR
JZSP-C7M175-15-E-G6	Flexible Power Cable (15m) 4 x 6.0mm <sup>2</sup> with M40 connector for SGM7A (7.0kW), SGM7G (5.5kW-7.5kW), SGM7G-44 High Speed (4.4kW)	671 EUR
JZSP-C7M175-20-E-G6	Flexible Power Cable (20m) 4 x 6.0mm <sup>2</sup> with M40 connector for SGM7A (7.0kW), SGM7G (5.5kW-7.5kW), SGM7G-44 High Speed (4.4kW)	847 EUR



**Servo Motor Power Cable flexible type for Motors with Brake SGM7G**

Ürün Kodu	Açıklama	Liste Fiyatı
JZSP-C7M344-03-E-G6	Flexible Power + Brake cable (3m) 4 x 1.5mm <sup>2</sup> + 2 x 1.5mm <sup>2</sup> M23 connector for SGM7J (1.5kW), SGM7A (1.0-2.5kW), SGM7G (0.5kW-2.0kW), SGM7G-05 to -09 High Speed	124 EUR
JZSP-C7M344-05-E-G6	Flexible Power + Brake cable (5m) 4 x 1.5mm <sup>2</sup> + 2 x 1.5mm <sup>2</sup> M23 connector for SGM7J (1.5kW), SGM7A (1.0-2.5kW), SGM7G (0.5kW-2.0kW), SGM7G-05 to -09 High Speed	155 EUR
JZSP-C7M344-10-E-G6	Flexible Power + Brake cable (10m) 4 x 1.5mm <sup>2</sup> + 2 x 1.5mm <sup>2</sup> M23 connector for SGM7J (1.5kW), SGM7A (1.0-2.5kW), SGM7G (0.5kW-2.0kW), SGM7G-05 to -09 High Speed	243 EUR
JZSP-C7M344-15-E-G6	Flexible Power + Brake cable (15m) 4 x 1.5mm <sup>2</sup> + 2 x 1.5mm <sup>2</sup> M23 connector for SGM7J (1.5kW), SGM7A (1.0-2.5kW), SGM7G (0.5kW-2.0kW), SGM7G-05 to -09 High Speed	348 EUR
JZSP-C7M344-20-E-G6	Flexible Power + Brake cable (20m) 4 x 1.5mm <sup>2</sup> + 2 x 1.5mm <sup>2</sup> M23 connector for SGM7J (1.5kW), SGM7A (1.0-2.5kW), SGM7G (0.5kW-2.0kW), SGM7G-05 to -09 High Speed	440 EUR
JZSP-C7M354-03-E-G6	Flexible Power + Brake cable (3m) 4 x 2.5mm <sup>2</sup> + 2 x 1.5mm <sup>2</sup> M23 connector for SGM7A (3.0kW), SGM7G (3.0kW), SGM7G (1.3 to 2.0kW) High Speed	143 EUR
JZSP-C7M354-05-E-G6	Flexible Power + Brake cable (5m) 4 x 2.5mm <sup>2</sup> + 2 x 1.5mm <sup>2</sup> M23 connector for SGM7A (3.0kW), SGM7G (3.0kW), SGM7G (1.3 to 2.0kW) High Speed	189 EUR
JZSP-C7M354-10-E-G6	Flexible Power + Brake cable (10m) 4 x 2.5mm <sup>2</sup> + 2 x 1.5mm <sup>2</sup> M23 connector for SGM7A (3.0kW), SGM7G (3.0kW), SGM7G (1.3 to 2.0kW) High Speed	313 EUR
JZSP-C7M354-15-E-G6	Flexible Power + Brake cable (15m) 4 x 2.5mm <sup>2</sup> + 2 x 1.5mm <sup>2</sup> M23 connector for SGM7A (3.0kW), SGM7G (3.0kW), SGM7G (1.3 to 2.0kW) High Speed	451 EUR
JZSP-C7M354-20-E-G6	Flexible Power + Brake cable (20m) 4 x 2.5mm <sup>2</sup> + 2 x 1.5mm <sup>2</sup> M23 connector for SGM7A (3.0kW), SGM7G (3.0kW), SGM7G (1.3 to 2.0kW) High Speed	575 EUR
JZSP-C7M364-03-E-G6	Flexible Power + Brake cable (3m) 4 x 4.0mm <sup>2</sup> + 2 x 1.5mm <sup>2</sup> M23 connector for SGM7A (4.0kW, 5.0kW), SGM7G (4.4kW), SGM7G (3.0kW) High Speed	179 EUR
JZSP-C7M364-05-E-G6	Flexible Power + Brake cable (5m) 4 x 4.0mm <sup>2</sup> + 2 x 1.5mm <sup>2</sup> M23 connector for SGM7A (4.0kW, 5.0kW), SGM7G (4.4kW), SGM7G (3.0kW) High Speed	246 EUR
JZSP-C7M364-10-E-G6	Flexible Power + Brake cable (10m) 4 x 4.0mm <sup>2</sup> + 2 x 1.5mm <sup>2</sup> M23 connector for SGM7A (4.0kW, 5.0kW), SGM7G (4.4kW), SGM7G (3.0kW) High Speed	415 EUR
JZSP-C7M364-15-E-G6	Flexible Power + Brake cable (15m) 4 x 4.0mm <sup>2</sup> + 2 x 1.5mm <sup>2</sup> M23 connector for SGM7A (4.0kW, 5.0kW), SGM7G (4.4kW), SGM7G (3.0kW) High Speed	601 EUR
JZSP-C7M364-20-E-G6	Flexible Power + Brake cable (20m) 4 x 4.0mm <sup>2</sup> + 2 x 1.5mm <sup>2</sup> M23 connector for SGM7A (4.0kW, 5.0kW), SGM7G (4.4kW), SGM7G (3.0kW) High Speed	773 EUR
JZSP-C7M375-03-E-G6	Flexible Power + Brake Cable (3m) 4 x 6.0mm <sup>2</sup> + 2 x 1.5mm <sup>2</sup> with M40 connector for SGM7A (7.0kW), SGM7G (5.5kW-7.5kW), SGM7G-44 High Speed (4.4kW)	281 EUR
JZSP-C7M375-05-E-G6	Flexible Power + Brake Cable (5m) 4 x 6.0mm <sup>2</sup> + 2 x 1.5mm <sup>2</sup> with M40 connector for SGM7A (7.0kW), SGM7G (5.5kW-7.5kW), SGM7G-44 High Speed (4.4kW)	358 EUR
JZSP-C7M375-10-E-G6	Flexible Power + Brake Cable (10m) 4 x 6.0mm <sup>2</sup> + 2 x 1.5mm <sup>2</sup> with M40 connector for SGM7A (7.0kW), SGM7G (5.5kW-7.5kW), SGM7G-44 High Speed (4.4kW)	561 EUR
JZSP-C7M375-15-E-G6	Flexible Power + Brake Cable (15m) 4 x 6.0mm <sup>2</sup> + 2 x 1.5mm <sup>2</sup> with M40 connector for SGM7A (7.0kW), SGM7G (5.5kW-7.5kW), SGM7G-44 High Speed (4.4kW)	773 EUR
JZSP-C7M375-20-E-G6	Flexible Power + Brake Cable (20m) 4 x 6.0mm <sup>2</sup> + 2 x 1.5mm <sup>2</sup> with M40 connector for SGM7A (7.0kW), SGM7G (5.5kW-7.5kW), SGM7G-44 High Speed (4.4kW)	983 EUR

**Incremental Encoder Cable flexible type with straight Connector SGM7G**

Ürün Kodu	Açıklama	Liste Fiyatı
JZSP-C7PI2M-03-E-G6	Flexible Encoder cable (3m) with straight connector M12 for all Sigma-7 400V Motors	136 EUR
JZSP-C7PI2M-05-E-G6	Flexible Encoder cable (5m) with straight connector M12 for all Sigma-7 400V Motors	155 EUR
JZSP-C7PI2M-10-E-G6	Flexible Encoder cable (10m) with straight connector M12 for all Sigma-7 400V Motors	216 EUR
JZSP-C7PI2M-15-E-G6	Flexible Encoder cable (15m) with straight connector M12 for all Sigma-7 400V Motors	282 EUR
JZSP-C7PI2M-20-E-G6	Flexible Encoder cable (20m) with straight connector M12 for all Sigma-7 400V Motors	344 EUR

**Incremental Encoder Cable flexible type with angled Connector SGM7G**

Ürün Kodu	Açıklama	Liste Fiyatı
JZSP-C7PI2N-03-E-G6	Flexible Encoder cable (3m) with angled connector M12 for all Sigma-7 400V Motors	140 EUR
JZSP-C7PI2N-05-E-G6	Flexible Encoder cable (5m) with angled connector M12 for all Sigma-7 400V Motors	155 EUR
JZSP-C7PI2N-10-E-G6	Flexible Encoder cable (10m) with angled connector M12 for all Sigma-7 400V Motors	220 EUR
JZSP-C7PI2N-15-E-G6	Flexible Encoder cable (15m) with angled connector M12 for all Sigma-7 400V Motors	282 EUR
JZSP-C7PI2N-20-E-G6	Flexible Encoder cable (20m) with angled connector M12 for all Sigma-7 400V Motors	348 EUR

**Special Cable for Extension for Absolut Encoder**

Ürün Kodu	Açıklama	Liste Fiyatı
JZSP-CSP12-E-G5	Extension Encoder cable with Connectors length 0.3m for Abs. Encoder, incl. Battery	100 EUR



## Servopack Sigma V - Analog / Pulse Type

@ 1/3 AC 230V, 50/60Hz, +10%/-15%,  
 @ 3 AC 380V – 480V, 50/60Hz, +10%/-15%  
 @ 0.05kW - 15kW (230V - 3.00kW)  
 @ UL-, CE-conform, RoHS-conform  
 @ Safety EN954 category 3 IEC61508 SIL2

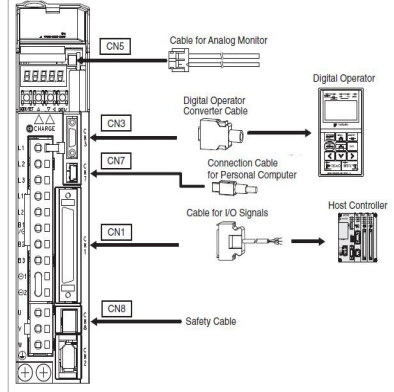

### Analog/Pulse SERVOPACK rotary SGD#-###01

Ürün Kodu	Açıklama	Liste Fiyatı
SGDV-R70A01A	Sigma 5 Servo Amplifier 0.05kW 1/3ph 230V Analog/Pulse Rotary	740 EUR
SGDV-R90A01A	Sigma 5 Servo Amplifier 0.10kW 1/3ph 230V Analog/Pulse Rotary	750 EUR
SGDV-1R6A01A	Sigma 5 Servo Amplifier 0.20kW 1/3ph 230V Analog/Pulse Rotary	804 EUR
SGDV-2R8A01A	Sigma 5 Servo Amplifier 0.40kW 1/3ph 230V Analog/Pulse Rotary	821 EUR
SGDV-5R5A01A	Sigma 5 Servo Amplifier 0.75kW 1/3ph 230V Analog/Pulse Rotary	854 EUR
SGDV-7R6A01A	Sigma 5 Servo Amplifier 1.00kW 3ph 230V Analog/Pulse Rotary	1.040 EUR
SGDV-120A01A008000	Sigma 5 Servo Amplifier 1.50kW 1ph 230V Analog/Pulse Rotary	1.181 EUR
SGDV-180A01A	Sigma 5 Servo Amplifier 2.00kW 3ph 230V Analog/Pulse Rotary	1.452 EUR
SGDV-200A01A	Sigma 5 Servo Amplifier 3.00kW 3ph 230V Analog/Pulse Rotary	1.850 EUR
SGDV-1R9D01A	Sigma 5 Servo Amplifier 0.50kW 3ph 400V Analog/Pulse Rotary	1.201 EUR
SGDV-3R5D01A	Sigma 5 Servo Amplifier 1.00kW 3ph 400V Analog/Pulse Rotary	1.242 EUR
SGDV-5R4D01A	Sigma 5 Servo Amplifier 1.50kW 3ph 400V Analog/Pulse Rotary	1.268 EUR
SGDV-8R4D01A	Sigma 5 Servo Amplifier 2.00kW 3ph 400V Analog/Pulse Rotary	1.499 EUR
SGDV-120D01A	Sigma 5 Servo Amplifier 3.00kW 3ph 400V Analog/Pulse Rotary	1.800 EUR
SGDV-170D01A	Sigma 5 Servo Amplifier 5.00kW 3ph 400V Analog/Pulse Rotary	2.299 EUR
SGDV-210D01A	Sigma 5 Servo Amplifier 6.00kW 3ph 400V Analog/Pulse Rotary	3.524 EUR
SGDV-260D01A	Sigma 5 Servo Amplifier 7.50kW 3ph 400V Analog/Pulse Rotary	3.792 EUR
SGDV-280D01A	Sigma 5 Servo Amplifier 11kW 3ph 400V Analog/Pulse Rotary	4.346 EUR
SGDV-370D01A	Sigma 5 Servo Amplifier 15kW 3ph 400V Analog/Pulse Rotary	4.614 EUR

### Analog/Pulse SERVOPACK linear SGD#-###05

Ürün Kodu	Açıklama	Liste Fiyatı
SGDV-R70A05A	Sigma 5 Servo Amplifier 0.05kW 1/3ph 230V Analog/Pulse Linear	991 EUR
SGDV-R90A05A	Sigma 5 Servo Amplifier 0.10kW 1/3ph 230V Analog/Pulse Linear	1.169 EUR
SGDV-1R6A05A	Sigma 5 Servo Amplifier 0.20kW 1/3ph 230V Analog/Pulse Linear	1.233 EUR
SGDV-2R8A05A	Sigma 5 Servo Amplifier 0.40kW 1/3ph 230V Analog/Pulse Linear	1.233 EUR
SGDV-5R5A05A	Sigma 5 Servo Amplifier 0.75kW 1/3ph 230V Analog/Pulse Linear	1.408 EUR
SGDV-7R6A05A	Sigma 5 Servo Amplifier 1.00kW 3ph 230V Analog/Pulse Linear	Sorunuz
SGDV-120A05A008000	Sigma 5 Servo Amplifier 1.50kW 1ph 230V Analog/Pulse Linear	1.477 EUR
SGDV-180A05A	Sigma 5 Servo Amplifier 2.00kW 3ph 230V Analog/Pulse Linear	1.579 EUR
SGDV-200A05A	Sigma 5 Servo Amplifier 3.00kW 3ph 230V Analog/Pulse Linear	2.011 EUR
SGDV-1R9D05A	Sigma 5 Servo Amplifier 0.50kW 3ph 400V Analog/Pulse Linear	1.288 EUR
SGDV-3R5D05A	Sigma 5 Servo Amplifier 1.00kW 3ph 400V Analog/Pulse Linear	1.371 EUR
SGDV-5R4D05A	Sigma 5 Servo Amplifier 1.50kW 3ph 400V Analog/Pulse Linear	1.460 EUR
SGDV-8R4D05A	Sigma 5 Servo Amplifier 2.00kW 3ph 400V Analog/Pulse Linear	1.599 EUR
SGDV-120D05A	Sigma 5 Servo Amplifier 3.00kW 3ph 400V Analog/Pulse Linear	2.154 EUR
SGDV-170D05A	Sigma 5 Servo Amplifier 5.00kW 3ph 400V Analog/Pulse Linear	2.726 EUR
SGDV-210D05A	Sigma 5 Servo Amplifier 6.00kW 3ph 400V Analog/Pulse Linear	4.552 EUR
SGDV-260D05A	Sigma 5 Servo Amplifier 7.50kW 3ph 400V Analog/Pulse Linear	5.536 EUR
SGDV-280D05A	Sigma 5 Servo Amplifier 11kW 3ph 400V Analog/Pulse Linear	6.345 EUR
SGDV-370D05A	Sigma 5 Servo Amplifier 15kW 3ph 400V Analog/Pulse Linear	6.915 EUR

## Analog/Pulse SERVOPACK Accessories SGDV-###01/05

Ürün Kodu	Açıklama	Liste Fiyatı
JUSP-TA50PG-E	CN1 I/O Connector with Terminal Block 0.5m	348 EUR
JUSP-TA50PG-1-E	CN1 I/O Connector with Terminal Block 1m	443 EUR
JUSP-TA50PG-2-E	CN1 I/O Connector with Terminal Block 2m	449 EUR
JZSP-CS101-1-E	CN1 I/O connector with flying lead cable 1m	125 EUR
JZSP-CS101-2-E	CN1 I/O connector with flying lead cable 2m	149 EUR
JZSP-CS101-3-E	CN1 I/O connector with flying lead cable 3m	158 EUR
JZSP-CS19-1-E	CN1 Connector Kit for I/O signal	53 EUR
CBK-U-MP2B-A5	Connector Terminal Converter for I/O Signals, 50-pin, length 0.5m	221 EUR
CBK-U-MP2B-01	Connector Terminal Converter for I/O Signals, 50-pin, length 1,0m	242 EUR
CBK-U-MP2A-01	Connector Terminal Converter for LIO-01/LIO-02 Module, length 1,0m	295 EUR
CBK-U-MP2C-01	Terminal Block Kit for MP3200 I/O, 64-Point I/O Module, 1,0m	213 EUR
JZSP-CVS05-A3-E	CN3 Digital Operator convertor cable 0.3m	161 EUR
JUSP-OP05A-1-E	CN3 Digital Operator with connection cable 1m	432 EUR
JZSP-CA01-E	CN5 Cable for Analog Monitor 1m	20 EUR
JZSP-CVS06-02-E	CN7 connection cable for PC 2.5m	113 EUR
JZSP-CVH03-03-E-G5	CN8 Cable with connecor for safety functions 3m	60 EUR
2013595-1	Safety Connector Kit for CN8	18 EUR
JZSP-CLP70-03-E-G5	CN31 Cable for connecting serial converter for Fully-closed for Sigma-5 (3m)	161 EUR
JZSP-CLP70-05-E-G5	CN31 Cable for connecting serial converter for Fully-closed for Sigma-5 (5m)	200 EUR
JZSP-CLP70-10-E-G5	CN31 Cable for connecting serial converter for Fully-closed for Sigma-5 (10m)	295 EUR
JZSP-CLP70-15-E-G5	CN31 Cable for connecting serial converter for Fully-closed for Sigma-5 (15m)	389 EUR
JUSP-RA18-E	Resistor for Sigma-5 for SGDV-210D+260D Type 400V Servo Amplifier	595 EUR
JUSP-RA19-E	Resistor for Sigma-5 for SGDV-280D+370D Type 400V Servo Amplifier	843 EUR
JZDP-D003-000-E	Serial Converter for external Encoder	564 EUR
JZDP-D005-000-E	Serial Converter for external Encoder	564 EUR
KLBUE 4-13.5 SET	Shielding clamp SET for motor cable 4-13.5mm <sup>2</sup> for Servopacks: Sigma 7 200V up to 750W, Sigma-5 200V up to 750W	10 EUR
KLBUE 4-13.5 SC	Shielding clamp for motor cable 4-13.5mm <sup>2</sup> for Servopacks: Sigma 7 400V up to 3.0 kW, Sigma 7 200V 1.5 kW 1ph, Sigma 5 200V 1.5 kW 1ph	7 EUR
SGDV-OSA01A	Advanced Safety Option Card	179 EUR
SGDV-OZA01A	Mounting Kit for Sigma-5 Option Cards	46 EUR
SGDV-OFB01A	Option Feedback Module for EnDat-2.1, EnDat-2.2, Hiperface, Sin/Cos	350 EUR
SGDV-OFB03A	Option Feedback Module for TTL Encoder incl. Cover	400 EUR
SGDV-OFB04A	Option Feedback Module for Resolver encoder incl. Cover	425 EUR
SGDV-OFA01A	Fully-closed Loop Option Card Sigma-5	81 EUR

## Filters for SGDV Servopacks

Ürün Kodu	Açıklama	Liste Fiyatı
RF 1005-SG5	Noise Filter for Sigma-5 for SGDV-R70A - 2R8A Type 230V Servo Amplifier	77 EUR
RF 1009-SG5-V2	Noise Filter for Sigma-5 for SGDV-5R5A Type 230V Servo Amplifier	105 EUR
RF 1016-SG5	Noise Filter for Sigma-5 for SGDV-120A Type 230V Servo Amplifier	123 EUR
RF 3004-SG5	Noise Filter for Sigma-5 for SGDV-1R9D - 5R4D Type 400V Servo Amplifier	117 EUR
RF 3008-SG5	Noise Filter for Sigma-5 for SGDV-8R4D - 120D Type 400V Servo Amplifier	164 EUR
RF 3012-SG5	Noise Filter for Sigma-5 for SGDV-170D Type 400V Servo Amplifier	175 EUR
RF 3022-SG5	Noise Filter for Sigma-5 for SGDV-210D - 260D Type 400V Servo Amplifier	175 EUR
RF 3044-SG5	Noise Filter for Sigma-5 for SGDV-280D - 370D Type 400V Servo Amplifier	220 EUR

## Filters for SGDV Servopacks (Combi Filters including control power)

Ürün Kodu	Açıklama	Liste Fiyatı
FESS-B005A	Noise Filter for Sigma-5 1ph for SGDV-R70A - 2R8A Type 230V Servo Amplifier	91 EUR
FESS-B009A	Noise Filter for Sigma-5 1ph for SGDV-5R5A & 7R6A Type 230V Servo Amplifier	119 EUR
FESS-B016A	Noise Filter for Sigma-5 1ph for SGDV-120A Type 230V Servo Amplifier	179 EUR

## Reactors for SGDV Servopacks

Ürün Kodu	Açıklama	Liste Fiyatı
X5059	DC Reactors for Sigma-5 for SGDV-200A Type 230V Servo Amplifier	258 EUR
X5060	DC Reactors for Sigma-5 for SGDV-120A - 180A Type 230V Servo Amplifier	238 EUR
X5061	DC Reactors for Sigma-5 for SGDV-R70A - 7R6A Type 230V Servo Amplifier	228 EUR
X5068	DC Reactors for Sigma-5 for SGDV-330A Type 230V Servo Amplifier	318 EUR
X5074	DC Reactors for Sigma-5 for SGDV-1R9D Type 400V Servo Amplifier	203 EUR
X5075	DC Reactors for Sigma-5 for SGDV-3R5D - 5R4D Type 400V Servo Amplifier	260 EUR
X5076	DC Reactors for Sigma-5 for SGDV-8R4D - 120D Type 400V Servo Amplifier	391 EUR
X5077	DC Reactors for Sigma-5 for SGDV-170D Type 400V Servo Amplifier	453 EUR



## Servopack Sigma V MINI for 24VDC / 48VDC Motors Analog Voltage Reference - Pulse Train Reference

@ 24VDC / 48VDC, 11W + 30W  
@ CE-conform

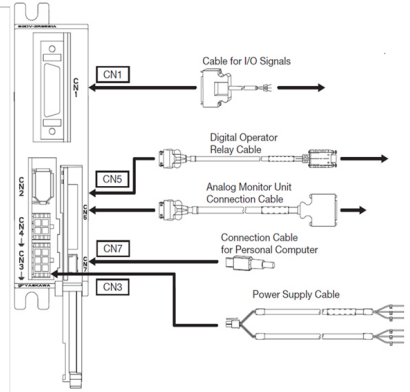

### Analog Voltage Reference SERVOPACK rotary SGDV-####S1 for 24VDC / 48VDC Motors

Ürün Kodu	Açıklama	Liste Fiyatı
SGDV-1R7ES1A	Sigma 5 Mini Servo Amplifier 11W, 24VDC / 48VDC, Analog Voltage Reference	675 EUR
SGDV-2R9ES1A	Sigma 5 Mini Servo Amplifier 30W, 24VDC / 48VDC, Analog Voltage Reference	708 EUR

### Pulse Train Reference SERVOPACK rotary SGDV-####P1 for 24VDC / 48VDC Motors

Ürün Kodu	Açıklama	Liste Fiyatı
SGDV-1R7EP1A	Sigma 5 Mini Servo Amplifier 11W, 24VDC / 48VDC, Pulse Train Reference	637 EUR
SGDV-2R9EP1A	Sigma 5 Mini Servo Amplifier 30W, 24VDC / 48VDC, Pulse Train Reference	637 EUR

### Accessories for SGDV-####S1/P1 - Analog Voltage Reference + Pulse Train Reference SERVOPACK

Ürün Kodu	Açıklama	Liste Fiyatı
JZSP-CSI9-2-E	CN1 connector kit for I/O signals	42 EUR
JUSP-TA26P-E	CN1 I/O Connector with Terminal Block 0.5m	425 EUR
JUSP-TA26P-1-E	CN1 I/O Connector with Terminal Block 1m	452 EUR
JUSP-TA26P-2-E	CN1 I/O Connector with Terminal Block 2m	474 EUR
JZSP-CSI02-1-E	CN1 I/O connector with flying lead cable 1m	99 EUR
JZSP-CSI02-2-E	CN1 I/O connector with flying lead cable 2m	121 EUR
JZSP-CSI02-3-E	CN1 I/O connector with flying lead cable 3m	151 EUR
JZSP-CF1G00-01-E	CN3 Power Supply Cable with loose wire at one end (1m)	60 EUR
JZSP-CF1G00-03-E	CN3 Power Supply Cable with loose wire at one end (3m)	88 EUR
JZSP-CF1G00-05-E	CN3 Power Supply Cable with loose wire at one end (5m)	118 EUR
JZSP-CF1G00-10-E	CN3 Power Supply Cable with loose wire at one end (10m)	190 EUR
JUSP-OP05A-1-E	CN3 Digital Operator with connection cable 1m	432 EUR
JZSP-CF1S00-A3-E	CN5 Digital Operator Relay Cable (0.3m)	220 EUR
JUSP-PC001-E	CN5 Analog Monitor Unit	494 EUR
JZSP-CF1S05-A3-E	CN5 Analog Monitor Unit Connection Cable (0.3m)	168 EUR
JZSP-CA01-E	CN5 Cable for Analog Monitor 1m	20 EUR
JZSP-CVS06-02-E	CN7 connection cable for PC 2.5m	113 EUR



## Servopack Sigma V - Analog / Pulse Type for Large Capacity Motors

@ 3ph 270 to 310 VDC, 50/60Hz, +10%/-15%, 22kW - 37kW  
 @ 3ph 520 to 650 VDC, 50/60Hz, +10%/-15%, 30kW - 55kW  
 @ UL-, CE-conform, RoHS-conform

### Analog/Pulse Large Capacity SERVOPACK SGDV-####01

Ürün Kodu	Açıklama	Liste Fiyatı
SGDV-121H01A	Sigma 5 Servo Amplifier 22kW 3ph 200V Analog/Pulse	6.862 EUR
SGDV-161H01A	Sigma 5 Servo Amplifier 30kW 3ph 200V Analog/Pulse	7.323 EUR
SGDV-201H01A	Sigma 5 Servo Amplifier 37kW 3ph 200V Analog/Pulse	10.200 EUR
SGDV-750J01A	Sigma 5 Servo Amplifier 30kW 3ph 400V Analog/Pulse	5.854 EUR
SGDV-101J01A	Sigma 5 Servo Amplifier 37kW 3ph 400V Analog/Pulse	6.175 EUR
SGDV-131J01A	Sigma 5 Servo Amplifier 55kW 3ph 400V Analog/Pulse	9.461 EUR

### Converter for Analog/Pulse Large Capacity SERVOPACK SGDV-####01

Ürün Kodu	Açıklama	Liste Fiyatı
SGDV-COA3ZDA	Converter for Sigma 5 LC 30kW 400V	5.872 EUR
SGDV-COA5EDA	Converter for Sigma 5 LC 55kW 400V	8.649 EUR

### Analog/Pulse Large Capacity SERVOPACK Accessories SGDV-####01

Ürün Kodu	Açıklama	Liste Fiyatı
HF3150C-UQB	Noise filter 400V, 150 Amps for SGDV-750J / -101J	3.096 EUR
HF3200C-UQB	Noise filter 400V, 200 Amps for SGDV-131J	3.553 EUR
JZSP-CSI9-1-E	CN1 Connector Kit for I/O signal	53 EUR
JJUSP-TA50PG-E	CN1 I/O Connector with Terminal Block 0.5m	348 EUR
JJUSP-TA50PG-1-E	CN1 I/O Connector with Terminal Block 1m	443 EUR
JJUSP-TA50PG-2-E	CN1 I/O Connector with Terminal Block 2m	449 EUR
JZSP-CSI01-1-E	CN1 I/O connector with flying lead cable 1m	125 EUR
JZSP-CSI01-2-E	CN1 I/O connector with flying lead cable 2m	149 EUR
JZSP-CSI01-3-E	CN1 I/O connector with flying lead cable 3m	158 EUR
JJUSP-OP05A-1-E	CN3 Digital Operator with connection cable 1m	432 EUR
JZSP-CVG00-A4-E	Control Power Cable between Servopack and Converter (24V)	36 EUR
JZSP-CVI02-A4-E	I/O Signal Cable between Servopack and Converter (24V)	328 EUR
JZSP-CVS05-A3-E	CN3 Digital Operator converter cable 0.3m	161 EUR
JZSP-CVS06-02-E	CN7 connection cable for PC 2.5m	113 EUR
JZSP-CA01-E	CN5 Cable for Analog Monitor 1m	20 EUR
JZSP-CVH03-03-E-G5	CN8 Cable with connector for safety functions 3m	60 EUR
2013595-1	Safety Connector Kit for CN 8	18 EUR
JZSP-CVD00-1A5-E	CN115 Dynamic Brake Unit Connection Cable (1.5m) Servopack end (only for Sigma V Large Capacity)	44 EUR
JZSP-CVD00-03-E	CN115 Dynamic Brake Unit Connection Cable (3m) Servopack end (only for Sigma V Large Capacity)	51 EUR
JJUSP-DB02-E	Dynamic Brake Unit 180 W, 0.3 Ohm x 3 (for SGDV-121H, 161H, 201H)	Sorunuz
JJUSP-DB04-E	Dynamic Brake Unit 180 W, 0.8 Ohm x 3 (for SGDV-750J, 101J)	1.514 EUR
JJUSP-DB06-E	Dynamic Brake Unit 300 W, 0.8 Ohm x 3 (for SGDV-131J)	1.823 EUR
SGDV-OSA01A	Advanced Safety Option Card	179 EUR
SGDV-OFA01A	Fully-closed Loop Option Card Sigma-5	81 EUR



## Servopack Sigma V - Mechatrolink II Type

- @ 1/3 AC 230V, 50/60Hz, +10%/-15%,
- @ 3 AC 380V – 480V, 50/60Hz, +10%/-15%
- @ 0.05kW - 15kW (230V - 3.00kW)
- @ UL-, CE-conform, RoHS-conform
- @ Safety EN954 category 3 IEC61508 SIL2

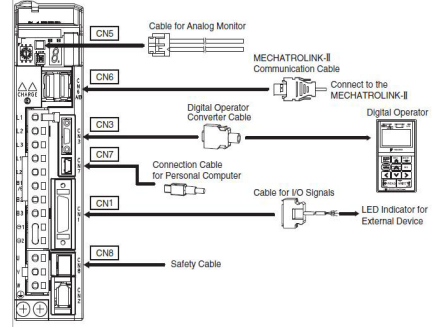

### Mechatrolink II SERVOPACK Rotary SGD#-###11

Ürün Kodu	Açıklama	Liste Fiyatı
SGDV-R70A11A	Sigma 5 Servo Amplifier 0.05kW 1/3ph 230V Mechatrolink II Rotary	741 EUR
SGDV-R90A11A	Sigma 5 Servo Amplifier 0.10kW 1/3ph 230V Mechatrolink II Rotary	753 EUR
SGDV-1R6A11A	Sigma 5 Servo Amplifier 0.20kW 1/3ph 230V Mechatrolink II Rotary	802 EUR
SGDV-2R8A11A	Sigma 5 Servo Amplifier 0.40kW 1/3ph 230V Mechatrolink II Rotary	861 EUR
SGDV-5R5A11A	Sigma 5 Servo Amplifier 0.75kW 1/3ph 230V Mechatrolink II Rotary	980 EUR
SGDV-7R6A11A	Sigma 5 Servo Amplifier 1.00kW 3ph 230V Mechatrolink II Rotary	1.035 EUR
SGDV-120A11A008000	Sigma 5 Servo Amplifier 1.50kW 1ph 230V Mechatrolink II Rotary	1.156 EUR
SGDV-180A11A	Sigma 5 Servo Amplifier 2.00kW 3ph 230V Mechatrolink II Rotary	1.421 EUR
SGDV-200A11A	Sigma 5 Servo Amplifier 3.00kW 3ph 230V Mechatrolink II Rotary	1.828 EUR
SGDV-1R9D11A	Sigma 5 Servo Amplifier 0.50kW 3ph 400V Mechatrolink II Rotary	1.204 EUR
SGDV-3R5D11A	Sigma 5 Servo Amplifier 1.00kW 3ph 400V Mechatrolink II Rotary	1.242 EUR
SGDV-5R4D11A	Sigma 5 Servo Amplifier 1.50kW 3ph 400V Mechatrolink II Rotary	1.268 EUR
SGDV-8R4D11A	Sigma 5 Servo Amplifier 2.00kW 3ph 400V Mechatrolink II Rotary	1.502 EUR
SGDV-120D11A	Sigma 5 Servo Amplifier 3.00kW 3ph 400V Mechatrolink II Rotary	1.847 EUR
SGDV-170D11A	Sigma 5 Servo Amplifier 5.00kW 3ph 400V Mechatrolink II Rotary	2.326 EUR
SGDV-210D11A	Sigma 5 Servo Amplifier 6.00kW 3ph 400V Mechatrolink II Rotary	3.564 EUR
SGDV-260D11A	Sigma 5 Servo Amplifier 7.50kW 3ph 400V Mechatrolink II Rotary	3.792 EUR
SGDV-280D11A	Sigma 5 Servo Amplifier 11kW 3ph 400V Mechatrolink II Rotary	4.346 EUR
SGDV-370D11A	Sigma 5 Servo Amplifier 15kW 3ph 400V Mechatrolink II Rotary	4.737 EUR

### Mechatrolink II SERVOPACK Linear SGD#-###15

Ürün Kodu	Açıklama	Liste Fiyatı
SGDV-R70A15A	Sigma 5 Servo Amplifier 0.05kW 1/3ph 230V Mechatrolink II Linear	991 EUR
SGDV-R90A15A	Sigma 5 Servo Amplifier 0.10kW 1/3ph 230V Mechatrolink II Linear	1.169 EUR
SGDV-1R6A15A	Sigma 5 Servo Amplifier 0.20kW 1/3ph 230V Mechatrolink II Linear	1.233 EUR
SGDV-2R8A15A	Sigma 5 Servo Amplifier 0.40kW 1/3ph 230V Mechatrolink II Linear	1.233 EUR
SGDV-5R5A15A	Sigma 5 Servo Amplifier 0.75kW 1/3ph 230V Mechatrolink II Linear	1.408 EUR
SGDV-7R6A15A	Sigma 5 Servo Amplifier 1.00kW 3ph 230V Mechatrolink II Linear	1.468 EUR
SGDV-120A15A008000	Sigma 5 Servo Amplifier 1.50kW 1ph 230V Mechatrolink II Linear	1.477 EUR
SGDV-180A15A	Sigma 5 Servo Amplifier 2.00kW 3ph 230V Mechatrolink II Linear	1.579 EUR
SGDV-200A15A	Sigma 5 Servo Amplifier 3.00kW 3ph 230V Mechatrolink II Linear	2.011 EUR
SGDV-1R9D15A	Sigma 5 Servo Amplifier 0.50kW 3ph 400V Mechatrolink II Linear	1.288 EUR
SGDV-3R5D15A	Sigma 5 Servo Amplifier 1.00kW 3ph 400V Mechatrolink II Linear	1.371 EUR
SGDV-5R4D15A	Sigma 5 Servo Amplifier 1.50kW 3ph 400V Mechatrolink II Linear	1.460 EUR
SGDV-8R4D15A	Sigma 5 Servo Amplifier 2.00kW 3ph 400V Mechatrolink II Linear	1.599 EUR
SGDV-120D15A	Sigma 5 Servo Amplifier 3.00kW 3ph 400V Mechatrolink II Linear	2.154 EUR
SGDV-170D15A	Sigma 5 Servo Amplifier 5.00kW 3ph 400V Mechatrolink II Linear	2.726 EUR
SGDV-210D15A	Sigma 5 Servo Amplifier 6.00kW 3ph 400V Mechatrolink II Linear	4.552 EUR
SGDV-260D15A	Sigma 5 Servo Amplifier 7.50kW 3ph 400V Mechatrolink II Linear	5.536 EUR
SGDV-280D15A	Sigma 5 Servo Amplifier 11kW 3ph 400V Mechatrolink II Linear	6.345 EUR
SGDV-370D15A	Sigma 5 Servo Amplifier 15kW 3ph 400V Mechatrolink II Linear	6.915 EUR

Ürün Kodu	Açıklama	Liste Fiyatı
JEPMC-W6002-A5-E	CN6 A/B MECHATROLINK II Communication Cable with connectors at both ends (0,5m)	67 EUR
JEPMC-W6002-01-E	CN6 A/B MECHATROLINK II Communication Cable with connectors at both ends (1m)	70 EUR
JEPMC-W6002-03-E	CN6 A/B MECHATROLINK II Communication Cable with connectors at both ends (2m)	81 EUR
JEPMC-W6002-05-E	CN6 A/B MECHATROLINK II Communication Cable with connectors at both ends (5m)	95 EUR
JEPMC-W6002-10-E	CN6 A/B MECHATROLINK II Communication Cable with connectors at both ends (10m)	113 EUR
JEPMC-W6002-20-E	CN6 A/B MECHATROLINK II Communication Cable with connectors at both ends (20m)	158 EUR
JEPMC-W6002-30-E	CN6 A/B MECHATROLINK II Communication Cable with connectors at both ends (30m)	301 EUR
JEPMC-W6002-40-E	CN6 A/B MECHATROLINK II Communication Cable with connectors at both ends (40m)	327 EUR
JEPMC-W6002-50-E	CN6 A/B MECHATROLINK II Communication Cable with connectors at both ends (50m)	355 EUR
JEPMC-W6003-A5-E-G5	CN6 A/B MECHATROLINK II Communication Cable with ring core (0,5m)	60 EUR
JEPMC-W6003-01-E-G5	CN6 A/B MECHATROLINK II Communication Cable with ring core (1m)	95 EUR
JEPMC-W6003-03-E-G5	CN6 A/B MECHATROLINK II Communication Cable with ring core (3m)	101 EUR
JEPMC-W6003-05-E-G5	CN6 A/B MECHATROLINK II Communication Cable with ring core (5m)	113 EUR
JEPMC-W6003-10-E-G5	CN6 A/B MECHATROLINK II Communication Cable with ring core (10m)	133 EUR
JEPMC-W6003-20-E-G5	CN6 A/B MECHATROLINK II Communication Cable with ring core (20m)	182 EUR
JEPMC-W6022-E	CN6 A/B MECHATROLINK II Terminator	27 EUR
JZSP-CVS05-A3-E	CN3 Digital Operator convertor cable 0.3m	161 EUR
JUSP-OP05A-1-E	CN3 Digital Operator with connection cable 1m	432 EUR
JUSP-TA26P-E	CN1 I/O Connector with Terminal Block 0.5m	425 EUR
JUSP-TA26P-1-E	CN1 I/O Connector with Terminal Block 1m	452 EUR
JUSP-TA26P-2-E	CN1 I/O Connector with Terminal Block 2m	474 EUR
SBK-U-VBA-01	Terminal block for I/O Signals, 26 Pins, length 1 m	229 EUR
JZSP-CA01-E	CN5 Cable for Analog Monitor 1m	20 EUR
JZSP-CSI02-1-E	CN1 I/O connector with flying lead cable 1m	99 EUR
JZSP-CSI02-2-E	CN1 I/O connector with flying lead cable 2m	121 EUR
JZSP-CSI02-3-E	CN1 I/O connector with flying lead cable 3m	151 EUR
JZSP-CSI9-2-E	CN1 connector kit for I/O signals	42 EUR
JZSP-CVH03-03-E-G5	CN8 Cable with connector for safety functions 3m	60 EUR
2013595-1	CN8 Connector kit for Safety	18 EUR
JZSP-CVS06-02-E	CN7 connection cable for PC 2.5m	113 EUR
JUSP-RA18-E	Resistor for Sigma-5 for SGDV-210D+260D Type 400V Servo Amplifier	595 EUR
JUSP-RA19-E	Resistor for Sigma-5 for SGDV-280D+370D Type 400V Servo Amplifier	843 EUR
JZDP-D003-000-E	Serial Converter for external Encoder	564 EUR
JZDP-D005-000-E	Serial Converter for external Encoder	564 EUR
JZSP-CLP70-03-E-G5	CN31 Cable for connecting serial converter for Fully-closed for Sigma-5 (3m)	161 EUR
JZSP-CLP70-05-E-G5	CN31 Cable for connecting serial converter for Fully-closed for Sigma-5 (5m)	200 EUR
JZSP-CLP70-10-E-G5	CN31 Cable for connecting serial converter for Fully-closed for Sigma-5 (10m)	295 EUR
JZSP-CLP70-15-E-G5	CN31 Cable for connecting serial converter for Fully-closed for Sigma-5 (15m)	389 EUR
KLBLUE 4-13.5 SET	Shielding clamp SET for motor cable 4-13.5mm <sup>2</sup> for Servopacks: Sigma 7 200V up to 750W, Sigma-5 200V up to 750W	10 EUR
KLBLUE 4-13.5 SC	Shielding clamp for motor cable 4-13.5mm <sup>2</sup> for Servopacks: Sigma 7 400V up to 3.0 kW, Sigma 7 200V 1.5 kW 1ph, Sigma 5 200V 1.5 kW 1ph	7 EUR
SGDV-OA01A	Advanced Safety Option Card	179 EUR
SGDV-OZA01A	Mounting Kit for Sigma-5 Option Cards	46 EUR
SGDV-OFB01A	Option Feedback Module for EnDat-2.1, EnDat-2.2, Hiperface, Sin/Cos	350 EUR
SGDV-OFB03A	Option Feedback Module for TTL Encoder incl. Cover	400 EUR
SGDV-OFB04A	Option Feedback Module for Resolver encoder incl. Cover	425 EUR
SGDV-OFA01A	Fully-closed Loop Option Card Sigma-5	81 EUR

## Filters for SGD Servopacks

Ürün Kodu	Açıklama	Liste Fiyatı
RF 1005-SG5	Noise Filter for Sigma-5 for SGD-R70A - 2R8A Type 230V Servo Amplifier	77 EUR
RF 1009-SG5-V2	Noise Filter for Sigma-5 for SGD-5R5A Type 230V Servo Amplifier	105 EUR
RF 1016-SG5	Noise Filter for Sigma-5 for SGD-120A Type 230V Servo Amplifier	123 EUR
RF 3004-SG5	Noise Filter for Sigma-5 for SGD-1R9D - 5R4D Type 400V Servo Amplifier	117 EUR
RF 3008-SG5	Noise Filter for Sigma-5 for SGD-8R4D - 120D Type 400V Servo Amplifier	164 EUR
RF 3012-SG5	Noise Filter for Sigma-5 for SGD-170D Type 400V Servo Amplifier	175 EUR
RF 3022-SG5	Noise Filter for Sigma-5 for SGD-210D - 260D Type 400V Servo Amplifier	175 EUR
RF 3044-SG5	Noise Filter for Sigma-5 for SGD-280D - 370D Type 400V Servo Amplifier	220 EUR

## Filters for SGD Servopacks (Combi Filters including control power)

Ürün Kodu	Açıklama	Liste Fiyatı
FESS-B005A	Noise Filter for Sigma-5 1ph for SGD-R70A - 2R8A Type 230V Servo Amplifier	91 EUR
FESS-B009A	Noise Filter for Sigma-5 1ph for SGD-5R5A & 7R6A Type 230V Servo Amplifier	119 EUR
FESS-B016A	Noise Filter for Sigma-5 1ph for SGD-120A Type 230V Servo Amplifier	179 EUR

## Reactors for SGD Servopacks

Ürün Kodu	Açıklama	Liste Fiyatı
X5059	DC Reactors for Sigma-5 for SGD-200A Type 230V Servo Amplifier	258 EUR
X5060	DC Reactors for Sigma-5 for SGD-120A - 180A Type 230V Servo Amplifier	238 EUR
X5061	DC Reactors for Sigma-5 for SGD-R70A - 7R6A Type 230V Servo Amplifier	228 EUR
X5068	DC Reactors for Sigma-5 for SGD-330A Type 230V Servo Amplifier	318 EUR
X5074	DC Reactors for Sigma-5 for SGD-1R9D Type 400V Servo Amplifier	203 EUR
X5075	DC Reactors for Sigma-5 for SGD-3R5D - 5R4D Type 400V Servo Amplifier	260 EUR
X5076	DC Reactors for Sigma-5 for SGD-8R4D - 120D Type 400V Servo Amplifier	391 EUR
X5077	DC Reactors for Sigma-5 for SGD-170D Type 400V Servo Amplifier	453 EUR





## Servopack Sigma V MINI for 24VDC / 48VDC Motors Mechatrolink II Type

@ 24VDC / 48VDC, 11W + 30W  
@ CE-conform

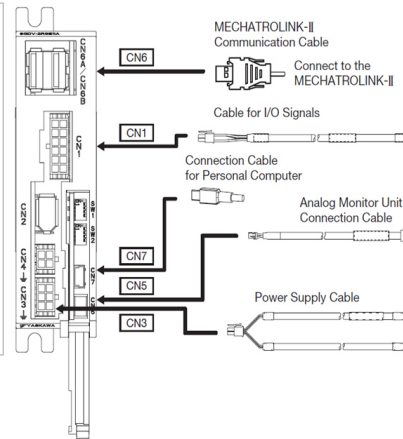

### Mechatrolink II SERVOPACK rotary SGD#-####11 for 24VDC / 48VDC Motors

Ürün Kodu	Açıklama	Liste Fiyatı
SGDV-1R7E11A	Sigma 5 Mini Servo Amplifier 11W, 24VDC / 48VDC, Mechatrolink II	712 EUR
SGDV-2R9E11A	Sigma 5 Mini Servo Amplifier 30W, 24VDC / 48VDC, Mechatrolink II	747 EUR

### Accessories for SGD#-####11 - Mechatrolink II SERVOPACK

Ürün Kodu	Açıklama	Liste Fiyatı
JZSP-CF1I02-1-E	CN1 Cable for I/O signals with loose wire at one end (1m)	81 EUR
JZSP-CF1I02-2-E	CN1 Cable for I/O signals with loose wire at one end (2m)	100 EUR
JZSP-CF1I02-3-E	CN1 Cable for I/O signals with loose wire at one end (3m)	120 EUR
JZSP-CF1G00-01-E	CN3 Power Supply Cable with loose wire at one end (1m)	60 EUR
JZSP-CF1G00-03-E	CN3 Power Supply Cable with loose wire at one end (3m)	88 EUR
JZSP-CF1G00-05-E	CN3 Power Supply Cable with loose wire at one end (5m)	118 EUR
JZSP-CF1G00-10-E	CN3 Power Supply Cable with loose wire at one end (10m)	190 EUR
JZSP-PC001-E	CN5 Analog Monitor Unit	494 EUR
JZSP-CF1S05-A3-E	CN5 Analog Monitor Unit Connection Cable (0.3m)	168 EUR
JZSP-CA01-E	CN5 Cable for Analog Monitor 1m	20 EUR
JEPMC-W6002-A5-E	CN6 A/B MECHATROLINK II Communication Cable with connectors at both ends (0,5m)	67 EUR
JEPMC-W6002-01-E	CN6 A/B MECHATROLINK II Communication Cable with connectors at both ends (1m)	70 EUR
JEPMC-W6002-03-E	CN6 A/B MECHATROLINK II Communication Cable with connectors at both ends (2m)	81 EUR
JEPMC-W6002-05-E	CN6 A/B MECHATROLINK II Communication Cable with connectors at both ends (5m)	95 EUR
JEPMC-W6002-10-E	CN6 A/B MECHATROLINK II Communication Cable with connectors at both ends (10m)	113 EUR
JEPMC-W6002-20-E	CN6 A/B MECHATROLINK II Communication Cable with connectors at both ends (20m)	158 EUR
JEPMC-W6002-30-E	CN6 A/B MECHATROLINK II Communication Cable with connectors at both ends (30m)	301 EUR
JEPMC-W6002-40-E	CN6 A/B MECHATROLINK II Communication Cable with connectors at both ends (40m)	327 EUR
JEPMC-W6002-50-E	CN6 A/B MECHATROLINK II Communication Cable with connectors at both ends (50m)	355 EUR
JEPMC-W6003-A5-E-G5	CN6 A/B MECHATROLINK II Communication Cable with ring core (0,5m)	60 EUR
JEPMC-W6003-01-E-G5	CN6 A/B MECHATROLINK II Communication Cable with ring core (1m)	95 EUR
JEPMC-W6003-03-E-G5	CN6 A/B MECHATROLINK II Communication Cable with ring core (3m)	101 EUR
JEPMC-W6003-05-E-G5	CN6 A/B MECHATROLINK II Communication Cable with ring core (5m)	113 EUR
JEPMC-W6003-10-E-G5	CN6 A/B MECHATROLINK II Communication Cable with ring core (10m)	133 EUR
JEPMC-W6003-20-E-G5	CN6 A/B MECHATROLINK II Communication Cable with ring core (20m)	182 EUR
JEPMC-W6022-E	CN6 A/B MECHATROLINK II Terminator	27 EUR
JZSP-CVS06-02-E	CN7 connection cable for PC 2.5m	113 EUR



## Servopack Sigma V - Mechatrolink II Type for Large Capacity Motors

@ 3ph 270 to 310 VDC, 50/60Hz, +10%/-15%, 22kW - 37kW  
 @ 3ph 520 to 650 VDC, 50/60Hz, +10%/-15%, 30kW - 55kW  
 @ UL-, CE-conform, RoHS-conform

### Mechatrolink II Large Capacity SERVOPACK SGD V-####11

Ürün Kodu	Açıklama	Liste Fiyatı
SGDV-121H11A	Sigma 5 Servo Amplifier 22kW 3ph 200V Mechatrolink II	7.220 EUR
SGDV-161H11A	Sigma 5 Servo Amplifier 30kW 3ph 200V Mechatrolink II	7.683 EUR
SGDV-201H11A	Sigma 5 Servo Amplifier 37kW 3ph 200V Mechatrolink II	10.614 EUR
SGDV-750J11A	Sigma 5 Servo Amplifier 30kW 3ph 400V Mechatrolink II	6.245 EUR
SGDV-101J11A	Sigma 5 Servo Amplifier 37kW 3ph 400V Mechatrolink II	6.556 EUR
SGDV-131J11A	Sigma 5 Servo Amplifier 55kW 3ph 400V Mechatrolink II	10.028 EUR

### Converter for Mechatrolink II Large Capacity SERVOPACK SGD V-####11

Ürün Kodu	Açıklama	Liste Fiyatı
SGDV-COA3ZDA	Converter for Sigma 5 LC 30kW 400V	5.872 EUR
SGDV-COA5EDA	Converter for Sigma 5 LC 55kW 400V	8.649 EUR

### Mechatrolink II Large Capacity SERVOPACK Accessories SGD V-####11

Ürün Kodu	Açıklama	Liste Fiyatı
HF3150C-UQB	Noise filter 400V, 150 Amps for SGD V-750J / -101J	3.096 EUR
HF3200C-UQB	Noise filter 400V, 200 Amps for SGD V-131J	3.553 EUR
JZSP-CSI9-1-E	CN1 Connector Kit for I/O signal	53 EUR
JUSP-TA50PG-E	CN1 I/O Connector with Terminal Block 0.5m	348 EUR
JUSP-TA50PG-1-E	CN1 I/O Connector with Terminal Block 1m	443 EUR
JUSP-TA50PG-2-E	CN1 I/O Connector with Terminal Block 2m	449 EUR
JZSP-CSI01-1-E	CN1 I/O connector with flying lead cable 1m	125 EUR
JZSP-CSI01-2-E	CN1 I/O connector with flying lead cable 2m	149 EUR
JZSP-CSI01-3-E	CN1 I/O connector with flying lead cable 3m	158 EUR
JUSP-OP05A-1-E	CN3 Digital Operator with connection cable 1m	432 EUR
JZSP-CVS05-A3-E	CN3 Digital Operator convertor cable 0.3m	161 EUR
JZSP-CA01-E	CN5 Cable for Analog Monitor 1m	20 EUR
JEPMC-W6002-A5-E	CN6 A/B MECHATROLINK II Communication Cable with connectors at both ends (0,5m)	67 EUR
JEPMC-W6002-01-E	CN6 A/B MECHATROLINK II Communication Cable with connectors at both ends (1m)	70 EUR
JEPMC-W6002-03-E	CN6 A/B MECHATROLINK II Communication Cable with connectors at both ends (2m)	81 EUR
JEPMC-W6002-05-E	CN6 A/B MECHATROLINK II Communication Cable with connectors at both ends (5m)	95 EUR
JEPMC-W6002-10-E	CN6 A/B MECHATROLINK II Communication Cable with connectors at both ends (10m)	113 EUR
JEPMC-W6002-20-E	CN6 A/B MECHATROLINK II Communication Cable with connectors at both ends (20m)	158 EUR
JEPMC-W6002-30-E	CN6 A/B MECHATROLINK II Communication Cable with connectors at both ends (30m)	301 EUR
JEPMC-W6002-40-E	CN6 A/B MECHATROLINK II Communication Cable with connectors at both ends (40m)	327 EUR
JEPMC-W6002-50-E	CN6 A/B MECHATROLINK II Communication Cable with connectors at both ends (50m)	355 EUR
JEPMC-W6003-A5-E-G5	CN6 A/B MECHATROLINK II Communication Cable with ring core (0,5m)	60 EUR
JEPMC-W6003-01-E-G5	CN6 A/B MECHATROLINK II Communication Cable with ring core (1m)	95 EUR
JEPMC-W6003-03-E-G5	CN6 A/B MECHATROLINK II Communication Cable with ring core (3m)	101 EUR
JEPMC-W6003-05-E-G5	CN6 A/B MECHATROLINK II Communication Cable with ring core (5m)	113 EUR
JEPMC-W6003-10-E-G5	CN6 A/B MECHATROLINK II Communication Cable with ring core (10m)	133 EUR
JEPMC-W6003-20-E-G5	CN6 A/B MECHATROLINK II Communication Cable with ring core (20m)	182 EUR
JEPMC-W6022-E	CN6 A/B MECHATROLINK II Terminator	27 EUR
JZSP-CVG00-A4-E	Control Power Cable between Servopack and Converter (24V)	36 EUR
JZSP-CVI02-A4-E	I/O Signal Cable between Servopack and Converter (24V)	328 EUR
JZSP-CVS06-02-E	CN7 connection cable for PC 2,5m	113 EUR
JZSP-CVH03-03-E-G5	CN8 Cable with connector for safety functions 3m	60 EUR
2013595-1	Safety Connector Kit for CN 8	18 EUR
JZSP-CVD00-1A5-E	CN115 Dynamic Brake Unit Connection Cable (1.5m) Servopack end (only for Sigma V Large Capacity)	44 EUR
JZSP-CVD00-03-E	CN115 Dynamic Brake Unit Connection Cable (3m) Servopack end (only for Sigma V Large Capacity)	51 EUR
JUSP-DB02-E	Dynamic Brake Unit 180 W, 0.3 Ohm x 3 (for SGD V-121H, 161H, 201H)	Sorunuz
JUSP-DB04-E	Dynamic Brake Unit 180 W, 0.8 Ohm x 3 (for SGD V-750J, 101J)	1.514 EUR

# YASKAWA

JUSP-DB06-E	Dynamic Brake Unit 300 W, 0.8 Ohm x 3 (for SGDV-131J)	1.823 EUR
SGDV-OSA01A	Advanced Safety Option Card	179 EUR
SGDV-OFA01A	Fully-closed Loop Option Card Sigma-5	81 EUR



## Servopack Sigma V - Mechatrolink III Type

- @ 1/3 AC 230V, 50/60Hz, +10%/-15%,
- @ 3 AC 380V – 480V, 50/60Hz, +10%/-15%
- @ 0.05kW - 15kW (230V - 3.00kW)
- @ UL-, CE-conform, RoHS-conform
- @ Safety EN954 category 3 IEC61508 SIL2

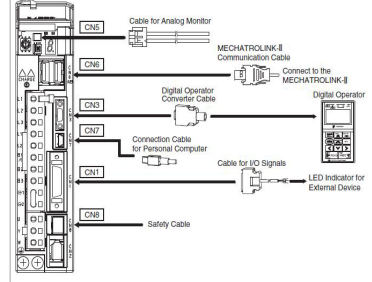

### Mechatrolink III SERVOPACK Rotary SGDV-###21

Ürün Kodu	Açıklama	Liste Fiyatı
SGDV-R70A21A	Sigma 5 Servo Amplifier 0.05kW 1/3ph 230V Mechatrolink III Rotary	926 EUR
SGDV-R90A21A	Sigma 5 Servo Amplifier 0.10kW 1/3ph 230V Mechatrolink III Rotary	926 EUR
SGDV-1R6A21A	Sigma 5 Servo Amplifier 0.20kW 1/3ph 230V Mechatrolink III Rotary	981 EUR
SGDV-2R8A21A	Sigma 5 Servo Amplifier 0.40kW 1/3ph 230V Mechatrolink III Rotary	953 EUR
SGDV-5R5A21A	Sigma 5 Servo Amplifier 0.75kW 1/3ph 230V Mechatrolink III Rotary	1.108 EUR
SGDV-7R6A21A	Sigma 5 Servo Amplifier 1.00kW 3ph 230V Mechatrolink III Rotary	1.163 EUR
SGDV-120A21A008000	Sigma 5 Servo Amplifier 1.50kW 1ph 230V Mechatrolink III Rotary	1.502 EUR
SGDV-180A21A	Sigma 5 Servo Amplifier 2.00kW 3ph 230V Mechatrolink III Rotary	1.665 EUR
SGDV-200A21A	Sigma 5 Servo Amplifier 3.00kW 3ph 230V Mechatrolink III Rotary	2.057 EUR
SGDV-1R9D21A	Sigma 5 Servo Amplifier 0.50kW 3ph 400V Mechatrolink III Rotary	1.347 EUR
SGDV-3R5D21A	Sigma 5 Servo Amplifier 1.00kW 3ph 400V Mechatrolink III Rotary	1.467 EUR
SGDV-5R4D21A	Sigma 5 Servo Amplifier 1.50kW 3ph 400V Mechatrolink III Rotary	1.474 EUR
SGDV-8R4D21A	Sigma 5 Servo Amplifier 2.00kW 3ph 400V Mechatrolink III Rotary	1.657 EUR
SGDV-120D21A	Sigma 5 Servo Amplifier 3.00kW 3ph 400V Mechatrolink III Rotary	1.912 EUR
SGDV-170D21A	Sigma 5 Servo Amplifier 5.00kW 3ph 400V Mechatrolink III Rotary	2.709 EUR
SGDV-210D21A	Sigma 5 Servo Amplifier 6.00kW 3ph 400V Mechatrolink III Rotary	3.599 EUR
SGDV-260D21A	Sigma 5 Servo Amplifier 7.50kW 3ph 400V Mechatrolink III Rotary	3.875 EUR
SGDV-280D21A	Sigma 5 Servo Amplifier 11kW 3ph 400V Mechatrolink III Rotary	4.451 EUR
SGDV-370D21A	Sigma 5 Servo Amplifier 15kW 3ph 400V Mechatrolink III Rotary	4.579 EUR

### Mechatrolink III SERVOPACK Linear SGDV-###25

Ürün Kodu	Açıklama	Liste Fiyatı
SGDV-R70A25A	Sigma 5 Servo Amplifier 0.05kW 1/3ph 230V Mechatrolink III Linear	Sorunuz
SGDV-R90A25A	Sigma 5 Servo Amplifier 0.10kW 1/3ph 230V Mechatrolink III Linear	Sorunuz
SGDV-1R6A25A	Sigma 5 Servo Amplifier 0.20kW 1/3ph 230V Mechatrolink III Linear	Sorunuz
SGDV-2R8A25A	Sigma 5 Servo Amplifier 0.40kW 1/3ph 230V Mechatrolink III Linear	Sorunuz
SGDV-5R5A25A	Sigma 5 Servo Amplifier 0.75kW 1/3ph 230V Mechatrolink III Linear	1.305 EUR
SGDV-7R6A25A	Sigma 5 Servo Amplifier 1.00kW 3ph 230V Mechatrolink III Linear	Sorunuz
SGDV-120A25A008000	Sigma 5 Servo Amplifier 1.50kW 1ph 230V Mechatrolink III Linear	Sorunuz
SGDV-180A25A	Sigma 5 Servo Amplifier 2.00kW 3ph 230V Mechatrolink III Linear	Sorunuz
SGDV-200A25A	Sigma 5 Servo Amplifier 3.00kW 3ph 230V Mechatrolink III Linear	Sorunuz
SGDV-1R9D25A	Sigma 5 Servo Amplifier 0.50kW 3ph 400V Mechatrolink III Linear	Sorunuz
SGDV-3R5D25A	Sigma 5 Servo Amplifier 1.00kW 3ph 400V Mechatrolink III Linear	Sorunuz
SGDV-5R4D25A	Sigma 5 Servo Amplifier 1.50kW 3ph 400V Mechatrolink III Linear	Sorunuz
SGDV-8R4D25A	Sigma 5 Servo Amplifier 2.00kW 3ph 400V Mechatrolink III Linear	Sorunuz
SGDV-120D25A	Sigma 5 Servo Amplifier 3.00kW 3ph 400V Mechatrolink III Linear	Sorunuz
SGDV-170D25A	Sigma 5 Servo Amplifier 5.00kW 3ph 400V Mechatrolink III Linear	Sorunuz
SGDV-210D25A	Sigma 5 Servo Amplifier 6.00kW 3ph 400V Mechatrolink III Linear	Sorunuz
SGDV-260D25A	Sigma 5 Servo Amplifier 7.50kW 3ph 400V Mechatrolink III Linear	Sorunuz
SGDV-280D25A	Sigma 5 Servo Amplifier 11kW 3ph 400V Mechatrolink III Linear	Sorunuz
SGDV-370D25A	Sigma 5 Servo Amplifier 15kW 3ph 400V Mechatrolink III Linear	Sorunuz

Mechatrolink III SERVOPACK accessories SGD#-###21/25

Ürün Kodu	Açıklama	Liste Fiyatı
JZSP-CSI9-2-E	CN1 connector kit for I/O signals	42 EUR
JZSP-CSI02-1-E	CN1 I/O connector with flying lead cable 1m	99 EUR
JZSP-CSI02-2-E	CN1 I/O connector with flying lead cable 2m	121 EUR
JZSP-CSI02-3-E	CN1 I/O connector with flying lead cable 3m	151 EUR
JUSP-TA26P-E	CN1 I/O Connector with Terminal Block 0.5m	425 EUR
JUSP-TA26P-1-E	CN1 I/O Connector with Terminal Block 1m	452 EUR
JUSP-TA26P-2-E	CN1 I/O Connector with Terminal Block 2m	474 EUR
SBK-U-VBA-01	Terminal block for I/O Signals, 26 Pins, length 1 m	229 EUR
JUSP-OP05A-1-E	CN3 Digital Operator with connection cable 1m	432 EUR
JZSP-CVS05-A3-E	CN3 Digital Operator convertor cable with Connectors at both ends 0.3m	161 EUR
JZSP-CVS07-A3-E	CN3 Digital Operator convertor cable with lock screws 0.3m	215 EUR
JZSP-CA01-E	CN5 Cable for Analog Monitor 1m	20 EUR
JEPMC-W6012-A2-E	CN6 A/B MECHATROLINK-III communication cable connectors on both ends (0,2m)	53 EUR
JEPMC-W6012-A5-E	CN6 A/B MECHATROLINK-III communication cable connectors on both ends (0,5m)	56 EUR
JEPMC-W6012-01-E	CN6 A/B MECHATROLINK-III communication cable connectors on both ends (1m)	67 EUR
JEPMC-W6012-02-E	CN6 A/B MECHATROLINK-III communication cable connectors on both ends (2m)	87 EUR
JEPMC-W6012-03-E	CN6 A/B MECHATROLINK-III communication cable connectors on both ends (3m)	105 EUR
JEPMC-W6012-05-E	CN6 A/B MECHATROLINK-III communication cable connectors on both ends (5m)	149 EUR
JEPMC-W6012-10-E	CN6 A/B MECHATROLINK-III communication cable connectors on both ends (10m)	232 EUR
JEPMC-W6012-20-E	CN6 A/B MECHATROLINK-III communication cable connectors on both ends (20m)	414 EUR
JEPMC-W6012-30-E	CN6 A/B MECHATROLINK-III communication cable connectors on both ends (30m)	593 EUR
JEPMC-W6012-50-E	CN6 A/B MECHATROLINK-III communication cable connectors on both ends (50m)	955 EUR
JEPMC-W6013-10-E	CN6 A/B MECHATROLINK-III communication cable connectors on both ends and ring core (10m)	283 EUR
JEPMC-W6013-20-E	CN6 A/B MECHATROLINK-III communication cable connectors on both ends and ring core (20m)	456 EUR
JEPMC-W6013-30-E	CN6 A/B MECHATROLINK-III communication cable connectors on both ends and ring core (30m)	627 EUR
JEPMC-W6013-50-E	CN6 A/B MECHATROLINK-III communication cable connectors on both ends and ring core (50m)	978 EUR
JEPMC-W6014-A5-E	CN6 A/B MECHATROLINK-III communication cable with loose wire at one end (0,5m)	38 EUR
JEPMC-W6014-01-E	CN6 A/B MECHATROLINK-III communication cable with loose wire at one end (1m)	45 EUR
JEPMC-W6014-03-E	CN6 A/B MECHATROLINK-III communication cable with loose wire at one end (3m)	87 EUR
JEPMC-W6014-05-E	CN6 A/B MECHATROLINK-III communication cable with loose wire at one end (5m)	125 EUR
JEPMC-W6014-10-E	CN6 A/B MECHATROLINK-III communication cable with loose wire at one end (10m)	214 EUR
JEPMC-W6014-30-E	CN6 A/B MECHATROLINK-III communication cable with loose wire at one end (30m)	580 EUR
JEPMC-W6014-50-E	CN6 A/B MECHATROLINK-III communication cable with loose wire at one end (50m)	931 EUR
JZSP-CVS06-02-E	CN7 connection cable for PC 2.5m	113 EUR
JZSP-CVH03-03-E-G5	CN8 Cable with connecor for safety functions 3m	60 EUR
2013595-1	CN8 Connector kit for Safety	18 EUR
JZSP-CLP70-03-E-G5	CN31 Cable for connecting serial converter for Fully-closed for Sigma-5 (3m)	161 EUR
JZSP-CLP70-05-E-G5	CN31 Cable for connecting serial converter for Fully-closed for Sigma-5 (5m)	200 EUR
JZSP-CLP70-10-E-G5	CN31 Cable for connecting serial converter for Fully-closed for Sigma-5 (10m)	295 EUR
JZSP-CLP70-15-E-G5	CN31 Cable for connecting serial converter for Fully-closed for Sigma-5 (15m)	389 EUR
JUSP-RA18-E	Resistor for Sigma-5 for SGD#-210D+260D Type 400V Servo Amplifier	595 EUR
JUSP-RA19-E	Resistor for Sigma-5 for SGD#-280D+370D Type 400V Servo Amplifier	843 EUR
JZDP-D003-000-E	Serial Converter for external Encoder	564 EUR
JZDP-D005-000-E	Serial Converter for external Encoder	564 EUR
KLBLUE 4-13.5 SET	Shielding clamp SET for motor cable 4-13.5mm <sup>2</sup> for Servopacks: Sigma 7 200V up to 750W, Sigma-5 200V up to 750W	10 EUR
KLBLUE 4-13.5 SC	Shielding clamp for motor cable 4-13.5mm <sup>2</sup> for Servopacks: Sigma 7 400V up to 3.0 kW, Sigma 7 200V 1.5 kW 1ph, Sigma 5 200V 1.5 kW 1ph	7 EUR
SGDV-OSA01A	Advanced Safety Option Card	179 EUR
SGDV-OZA01A	Mounting Kit for Sigma-5 Option Cards	46 EUR
SGDV-OFB01A	Option Feedback Module for EnDat-2.1, EnDat-2.2, Hiperface, Sin/Cos	350 EUR
SGDV-OFB03A	Option Feedback Module for TTL Encoder incl. Cover	400 EUR
SGDV-OFB04A	Option Feedback Module for Resolver encoder incl. Cover	425 EUR
SGDV-OFA01A	Fully-closed Loop Option Card Sigma-5	81 EUR

## Filters for SGD Servopacks

Ürün Kodu	Açıklama	Liste Fiyatı
RF 1005-SG5	Noise Filter for Sigma-5 for SGD-R70A - 2R8A Type 230V Servo Amplifier	77 EUR
RF 1009-SG5-V2	Noise Filter for Sigma-5 for SGD-5R5A Type 230V Servo Amplifier	105 EUR
RF 1016-SG5	Noise Filter for Sigma-5 for SGD-120A Type 230V Servo Amplifier	123 EUR
RF 3004-SG5	Noise Filter for Sigma-5 for SGD-1R9D - 5R4D Type 400V Servo Amplifier	117 EUR
RF 3008-SG5	Noise Filter for Sigma-5 for SGD-8R4D - 120D Type 400V Servo Amplifier	164 EUR
RF 3012-SG5	Noise Filter for Sigma-5 for SGD-170D Type 400V Servo Amplifier	175 EUR
RF 3022-SG5	Noise Filter for Sigma-5 for SGD-210D - 260D Type 400V Servo Amplifier	175 EUR
RF 3044-SG5	Noise Filter for Sigma-5 for SGD-280D - 370D Type 400V Servo Amplifier	220 EUR

## Filters for SGD Servopacks (Combi Filters including control power)

Ürün Kodu	Açıklama	Liste Fiyatı
FESS-B005A	Noise Filter for Sigma-5 1ph for SGD-R70A - 2R8A Type 230V Servo Amplifier	91 EUR
FESS-B009A	Noise Filter for Sigma-5 1ph for SGD-5R5A & 7R6A Type 230V Servo Amplifier	119 EUR
FESS-B016A	Noise Filter for Sigma-5 1ph for SGD-120A Type 230V Servo Amplifier	179 EUR

## Reactors for SGD Servopacks

Ürün Kodu	Açıklama	Liste Fiyatı
X5059	DC Reactors for Sigma-5 for SGD-200A Type 230V Servo Amplifier	258 EUR
X5060	DC Reactors for Sigma-5 for SGD-120A - 180A Type 230V Servo Amplifier	238 EUR
X5061	DC Reactors for Sigma-5 for SGD-R70A - 7R6A Type 230V Servo Amplifier	228 EUR
X5068	DC Reactors for Sigma-5 for SGD-330A Type 230V Servo Amplifier	318 EUR
X5074	DC Reactors for Sigma-5 for SGD-1R9D Type 400V Servo Amplifier	203 EUR
X5075	DC Reactors for Sigma-5 for SGD-3R5D - 5R4D Type 400V Servo Amplifier	260 EUR
X5076	DC Reactors for Sigma-5 for SGD-8R4D - 120D Type 400V Servo Amplifier	391 EUR
X5077	DC Reactors for Sigma-5 for SGD-170D Type 400V Servo Amplifier	453 EUR



## Servopack Sigma V MINI for 24VDC / 48VDC Motors Mechatrolink III Type

@ 24VDC / 48VDC, 11W + 30W  
@ CE-conform

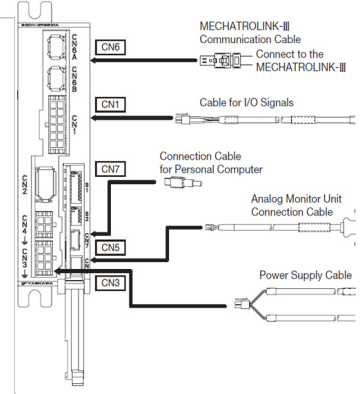

### Mechatrolink III SERVOPACK rotary SGD#-###21 for 24VDC / 48VDC Motors

Ürün Kodu	Açıklama	Liste Fiyatı
SGDV-1R7E21A	Sigma 5 Mini Servo Amplifier 11W, 24VDC / 48VDC, Mechatrolink III	712 EUR
SGDV-2R9E21A	Sigma 5 Mini Servo Amplifier 30W, 24VDC / 48VDC, Mechatrolink III	747 EUR

### Accessories for SGD#-###S1/P1 - Analog Voltage Reference + Pulse Train Reference SERVOPACK

Ürün Kodu	Açıklama	Liste Fiyatı
JZSP-CF1I02-1-E	CN1 Cable for I/O signals with loose wire at one end (1m)	81 EUR
JZSP-CF1I02-2-E	CN1 Cable for I/O signals with loose wire at one end (2m)	100 EUR
JZSP-CF1I02-3-E	CN1 Cable for I/O signals with loose wire at one end (3m)	120 EUR
JZSP-CF1G00-01-E	CN3 Power Supply Cable with loose wire at one end (1m)	60 EUR
JZSP-CF1G00-03-E	CN3 Power Supply Cable with loose wire at one end (3m)	88 EUR
JZSP-CF1G00-05-E	CN3 Power Supply Cable with loose wire at one end (5m)	118 EUR
JZSP-CF1G00-10-E	CN3 Power Supply Cable with loose wire at one end (10m)	190 EUR
JJSP-PC001-E	CN5 Analog Monitor Unit	494 EUR
JZSP-CF1S05-A3-E	CN5 Analog Monitor Unit Connection Cable (0.3m)	168 EUR
JZSP-CA01-E	CN5 Cable for Analog Monitor 1m	20 EUR
JEPMC-W6012-A2-E	CN6 A/B MECHATROLINK-III communication cable connectors on both ends (0,2m)	53 EUR
JEPMC-W6012-A5-E	CN6 A/B MECHATROLINK-III communication cable connectors on both ends (0,5m)	56 EUR
JEPMC-W6012-01-E	CN6 A/B MECHATROLINK-III communication cable connectors on both ends (1m)	67 EUR
JEPMC-W6012-02-E	CN6 A/B MECHATROLINK-III communication cable connectors on both ends (2m)	87 EUR
JEPMC-W6012-03-E	CN6 A/B MECHATROLINK-III communication cable connectors on both ends (3m)	105 EUR
JEPMC-W6012-05-E	CN6 A/B MECHATROLINK-III communication cable connectors on both ends (5m)	149 EUR
JEPMC-W6012-10-E	CN6 A/B MECHATROLINK-III communication cable connectors on both ends (10m)	232 EUR
JEPMC-W6012-20-E	CN6 A/B MECHATROLINK-III communication cable connectors on both ends (20m)	414 EUR
JEPMC-W6012-30-E	CN6 A/B MECHATROLINK-III communication cable connectors on both ends (30m)	593 EUR
JEPMC-W6012-50-E	CN6 A/B MECHATROLINK-III communication cable connectors on both ends (50m)	955 EUR
JEPMC-W6013-10-E	CN6 A/B MECHATROLINK-III communication cable connectors on both ends and ring core (10m)	283 EUR
JEPMC-W6013-20-E	CN6 A/B MECHATROLINK-III communication cable connectors on both ends and ring core (20m)	456 EUR
JEPMC-W6013-30-E	CN6 A/B MECHATROLINK-III communication cable connectors on both ends and ring core (30m)	627 EUR
JEPMC-W6013-50-E	CN6 A/B MECHATROLINK-III communication cable connectors on both ends and ring core (50m)	978 EUR
JEPMC-W6014-A5-E	CN6 A/B MECHATROLINK-III communication cable with loose wire at one end (0,5m)	38 EUR
JEPMC-W6014-01-E	CN6 A/B MECHATROLINK-III communication cable with loose wire at one end (1m)	45 EUR
JEPMC-W6014-03-E	CN6 A/B MECHATROLINK-III communication cable with loose wire at one end (3m)	87 EUR
JEPMC-W6014-05-E	CN6 A/B MECHATROLINK-III communication cable with loose wire at one end (5m)	125 EUR
JEPMC-W6014-10-E	CN6 A/B MECHATROLINK-III communication cable with loose wire at one end (10m)	214 EUR
JEPMC-W6014-30-E	CN6 A/B MECHATROLINK-III communication cable with loose wire at one end (30m)	580 EUR
JEPMC-W6014-50-E	CN6 A/B MECHATROLINK-III communication cable with loose wire at one end (50m)	931 EUR
JZSP-CVS06-02-E	CN7 connection cable for PC 2.5m	113 EUR



## Servopack Sigma V - Mechatrolink III Type for Large Capacity Motors

- @ 3ph 270 to 310 VDC, 50/60Hz, +10%/-15%, 22kW - 37kW
- @ 3ph 520 to 650 VDC, 50/60Hz, +10%/-15%, 30kW - 55kW
- @ UL-, CE-conform, RoHS-conform

### Mechatrolink III Large Capacity SERVOPACK SGDV-###21

Ürün Kodu	Açıklama	Liste Fiyatı
SGDV-121H21A	Sigma 5 Servo Amplifier 22kW 3ph 200V Mechatrolink III	7.421 EUR
SGDV-161H21A	Sigma 5 Servo Amplifier 30kW 3ph 200V Mechatrolink III	7.882 EUR
SGDV-201H21A	Sigma 5 Servo Amplifier 37kW 3ph 200V Mechatrolink III	10.810 EUR
SGDV-750J21A	Sigma 5 Servo Amplifier 30kW 3ph 400V Mechatrolink III	6.456 EUR
SGDV-101J21A	Sigma 5 Servo Amplifier 37kW 3ph 400V Mechatrolink III	6.768 EUR
SGDV-131J21A	Sigma 5 Servo Amplifier 55kW 3ph 400V Mechatrolink III	10.246 EUR

### Converter for Mechatrolink III Large Capacity SERVOPACK SGDV-###21

Ürün Kodu	Açıklama	Liste Fiyatı
SGDV-COA3ZDA	Converter for Sigma 5 LC 30kW 400V	5.872 EUR
SGDV-COA5EDA	Converter for Sigma 5 LC 55kW 400V	8.649 EUR

### Mechatrolink III Large Capacity SERVOPACK Accessories SGDV-###21

Ürün Kodu	Açıklama	Liste Fiyatı
HF3150C-UQB	Noise filter 400V, 150 Amps for SGDV-750J / -101J	3.096 EUR
HF3200C-UQB	Noise filter 400V, 200 Amps for SGDV-131J	3.553 EUR
JZSP-CSI9-1-E	CN1 Connector Kit for I/O signal	53 EUR
JUSP-TA50PG-E	CN1 I/O Connector with Terminal Block 0.5m	348 EUR
JUSP-TA50PG-1-E	CN1 I/O Connector with Terminal Block 1m	443 EUR
JUSP-TA50PG-2-E	CN1 I/O Connector with Terminal Block 2m	449 EUR
JZSP-CSI01-1-E	CN1 I/O connector with flying lead cable 1m	125 EUR
JZSP-CSI01-2-E	CN1 I/O connector with flying lead cable 2m	149 EUR
JZSP-CSI01-3-E	CN1 I/O connector with flying lead cable 3m	158 EUR
JUSP-OP05A-1-E	CN3 Digital Operator with connection cable 1m	432 EUR
JZSP-CVS05-A3-E	CN3 Digital Operator convertor cable 0.3m	161 EUR
JZSP-CA01-E	CN5 Cable for Analog Monitor 1m	20 EUR
JEPMC-W6012-A2-E	CN6 A/B MECHATROLINK-III communication cable connectors on both ends (0,2m)	53 EUR
JEPMC-W6012-A5-E	CN6 A/B MECHATROLINK-III communication cable connectors on both ends (0,5m)	56 EUR
JEPMC-W6012-01-E	CN6 A/B MECHATROLINK-III communication cable connectors on both ends (1m)	67 EUR
JEPMC-W6012-02-E	CN6 A/B MECHATROLINK-III communication cable connectors on both ends (2m)	87 EUR
JEPMC-W6012-03-E	CN6 A/B MECHATROLINK-III communication cable connectors on both ends (3m)	105 EUR
JEPMC-W6012-05-E	CN6 A/B MECHATROLINK-III communication cable connectors on both ends (5m)	149 EUR
JEPMC-W6012-10-E	CN6 A/B MECHATROLINK-III communication cable connectors on both ends (10m)	232 EUR
JEPMC-W6012-20-E	CN6 A/B MECHATROLINK-III communication cable connectors on both ends (20m)	414 EUR
JEPMC-W6012-30-E	CN6 A/B MECHATROLINK-III communication cable connectors on both ends (30m)	593 EUR
JEPMC-W6012-50-E	CN6 A/B MECHATROLINK-III communication cable connectors on both ends (50m)	955 EUR
JEPMC-W6013-10-E	CN6 A/B MECHATROLINK-III communication cable connectors on both ends and ring core (10m)	283 EUR
JEPMC-W6013-20-E	CN6 A/B MECHATROLINK-III communication cable connectors on both ends and ring core (20m)	456 EUR
JEPMC-W6013-30-E	CN6 A/B MECHATROLINK-III communication cable connectors on both ends and ring core (30m)	627 EUR
JEPMC-W6013-50-E	CN6 A/B MECHATROLINK-III communication cable connectors on both ends and ring core (50m)	978 EUR
JEPMC-W6014-A5-E	CN6 A/B MECHATROLINK-III communication cable with loose wire at one end (0,5m)	38 EUR
JEPMC-W6014-01-E	CN6 A/B MECHATROLINK-III communication cable with loose wire at one end (1m)	45 EUR
JEPMC-W6014-03-E	CN6 A/B MECHATROLINK-III communication cable with loose wire at one end (3m)	87 EUR
JEPMC-W6014-05-E	CN6 A/B MECHATROLINK-III communication cable with loose wire at one end (5m)	125 EUR
JEPMC-W6014-10-E	CN6 A/B MECHATROLINK-III communication cable with loose wire at one end (10m)	214 EUR
JEPMC-W6014-30-E	CN6 A/B MECHATROLINK-III communication cable with loose wire at one end (30m)	580 EUR
JEPMC-W6014-50-E	CN6 A/B MECHATROLINK-III communication cable with loose wire at one end (50m)	931 EUR
JZSP-CVG00-A4-E	Control Power Cable between Servopack and Converter (24V)	36 EUR
JZSP-CV02-A4-E	I/O Signal Cable between Servopack and Converter (24V)	328 EUR
JZSP-CVS06-02-E	CN7 connection cable for PC 2.5m	113 EUR
JZSP-CVH03-03-E-G5	CN8 Cable with connector for safety functions 3m	60 EUR
2013595-1	Safety Connector Kit for CN 8	18 EUR
JZSP-CVD00-1A5-E	CN115 Dynamic Brake Unit Connection Cable (1.5m) Servopack end (only for Sigma V Large Capacity)	44 EUR
JZSP-CVD00-03-E	CN115 Dynamic Brake Unit Connection Cable (3m) Servopack end (only for Sigma V Large Capacity)	51 EUR
JUSP-DB02-E	Dynamic Brake Unit 180 W, 0.3 Ohm x 3 (for SGDV-121H, 161H, 201H)	Sorunuz
JUSP-DB04-E	Dynamic Brake Unit 180 W, 0.8 Ohm x 3 (for SGDV-750J, 101J)	1.514 EUR
JUSP-DB06-E	Dynamic Brake Unit 300 W, 0.8 Ohm x 3 (for SGDV-131J)	1.823 EUR
SGDV-OSA01A	Advanced Safety Option Card	179 EUR
SGDV-OFA01A	Fully-closed Loop Option Card Sigma-5	81 EUR





## Servopack Sigma V - Other Network Type

- @ 1/3 AC 230V, 50/60Hz, +10%/-15%,
- @ 3 AC 380V – 480V, 50/60Hz, +10%/-15%
- @ 0.05kW - 15kW (230V - 3.00kW)
- @ UL-, CE-conform, RoHS-conform
- @ Needs an option card like ProfiNET, EtherCAT, etc.
- @ Safety EN954 category 3 IEC61508 SIL2

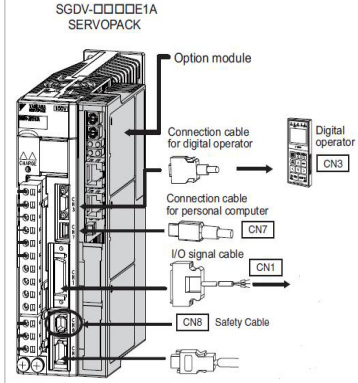

### Other Network SERVOPACK Rotary SGD#-###E1

Ürün Kodu	Açıklama	Liste Fiyatı
SGDV-R70AE1A	Sigma 5 Servo Amplifier 0.05kW 1/3ph 230V Other Network Rotary	842 EUR
SGDV-R90AE1A	Sigma 5 Servo Amplifier 0.10kW 1/3ph 230V Other Network Rotary	993 EUR
SGDV-1R6AE1A	Sigma 5 Servo Amplifier 0.20kW 1/3ph 230V Other Network Rotary	1.009 EUR
SGDV-2R8AE1A	Sigma 5 Servo Amplifier 0.40kW 1/3ph 230V Other Network Rotary	1.009 EUR
SGDV-5R5AE1A	Sigma 5 Servo Amplifier 0.75kW 1/3ph 230V Other Network Rotary	1.197 EUR
SGDV-7R6AE1A	Sigma 5 Servo Amplifier 1.00kW 3ph 230V Other Network Rotary	1.225 EUR
SGDV-120AE1A008000	Sigma 5 Servo Amplifier 1.50kW 1ph 230V Other Network Rotary	1.246 EUR
SGDV-180AE1A	Sigma 5 Servo Amplifier 2.00kW 3ph 230V Other Network Rotary	1.510 EUR
SGDV-200AE1A	Sigma 5 Servo Amplifier 3.00kW 3ph 230V Other Network Rotary	1.727 EUR
SGDV-1R9DE1A	Sigma 5 Servo Amplifier 0.50kW 3ph 400V Other Network Rotary	1.223 EUR
SGDV-3R5DE1A	Sigma 5 Servo Amplifier 1.00kW 3ph 400V Other Network Rotary	1.246 EUR
SGDV-5R4DE1A	Sigma 5 Servo Amplifier 1.50kW 3ph 400V Other Network Rotary	1.272 EUR
SGDV-8R4DE1A	Sigma 5 Servo Amplifier 2.00kW 3ph 400V Other Network Rotary	1.478 EUR
SGDV-120DE1A	Sigma 5 Servo Amplifier 3.00kW 3ph 400V Other Network Rotary	1.778 EUR
SGDV-170DE1A	Sigma 5 Servo Amplifier 5.00kW 3ph 400V Other Network Rotary	2.207 EUR
SGDV-210DE1A	Sigma 5 Servo Amplifier 6.00kW 3ph 400V Other Network Rotary	3.853 EUR
SGDV-260DE1A	Sigma 5 Servo Amplifier 7.50kW 3ph 400V Other Network Rotary	4.136 EUR
SGDV-280DE1A	Sigma 5 Servo Amplifier 11kW 3ph 400V Other Network Rotary	4.346 EUR
SGDV-370DE1A	Sigma 5 Servo Amplifier 15kW 3ph 400V Other Network Rotary	4.799 EUR

### Other Network SERVOPACK Linear SGD#-###E5

Ürün Kodu	Açıklama	Liste Fiyatı
SGDV-R70AE5A	Sigma 5 Servo Amplifier 0.05kW 1/3ph 230V Other Network Linear	906 EUR
SGDV-R90AE5A	Sigma 5 Servo Amplifier 0.10kW 1/3ph 230V Other Network Linear	1.169 EUR
SGDV-1R6AE5A	Sigma 5 Servo Amplifier 0.20kW 1/3ph 230V Other Network Linear	1.121 EUR
SGDV-2R8AE5A	Sigma 5 Servo Amplifier 0.40kW 1/3ph 230V Other Network Linear	1.121 EUR
SGDV-5R5AE5A	Sigma 5 Servo Amplifier 0.75kW 1/3ph 230V Other Network Linear	1.408 EUR
SGDV-7R6AE5A	Sigma 5 Servo Amplifier 1.00kW 3ph 230V Other Network Linear	Sorunuz
SGDV-120AE5A008000	Sigma 5 Servo Amplifier 1.50kW 1ph 230V Other Network Linear	1.284 EUR
SGDV-180AE5A	Sigma 5 Servo Amplifier 2.00kW 3ph 230V Other Network Linear	1.776 EUR
SGDV-200AE5A	Sigma 5 Servo Amplifier 3.00kW 3ph 230V Other Network Linear	2.262 EUR
SGDV-1R9DE5A	Sigma 5 Servo Amplifier 0.50kW 3ph 400V Other Network Linear	1.288 EUR
SGDV-3R5DE5A	Sigma 5 Servo Amplifier 1.00kW 3ph 400V Other Network Linear	1.311 EUR
SGDV-5R4DE5A	Sigma 5 Servo Amplifier 1.50kW 3ph 400V Other Network Linear	1.338 EUR
SGDV-8R4DE5A	Sigma 5 Servo Amplifier 2.00kW 3ph 400V Other Network Linear	1.523 EUR
SGDV-120DE5A	Sigma 5 Servo Amplifier 3.00kW 3ph 400V Other Network Linear	2.092 EUR
SGDV-170DE5A	Sigma 5 Servo Amplifier 5.00kW 3ph 400V Other Network Linear	2.596 EUR
SGDV-210DE5A	Sigma 5 Servo Amplifier 6.00kW 3ph 400V Other Network Linear	4.552 EUR
SGDV-260DE5A	Sigma 5 Servo Amplifier 7.50kW 3ph 400V Other Network Linear	6.644 EUR
SGDV-280DE5A	Sigma 5 Servo Amplifier 11kW 3ph 400V Other Network Linear	6.980 EUR
SGDV-370DE5A	Sigma 5 Servo Amplifier 15kW 3ph 400V Other Network Linear	8.298 EUR

## Other Network SERVOPACK accessories SGD#-###E1/E5 and Options

Ürün Kodu	Açıklama	Liste Fiyatı
JZSP-CSI9-2-E	CN1 connector kit for I/O signals	42 EUR
JUSP-TA26P-E	CN1 I/O Connector with Terminal Block 0.5m	425 EUR
JUSP-TA26P-1-E	CN1 I/O Connector with Terminal Block 1m	452 EUR
JUSP-TA26P-2-E	CN1 I/O Connector with Terminal Block 2m	474 EUR
SBK-U-VBA-01	Terminal block for I/O Signals, 26 Pins, length 1 m	229 EUR
JZSP-CSI02-1-E	CN1 I/O connector with flying lead cable 1m	99 EUR
JZSP-CSI02-2-E	CN1 I/O connector with flying lead cable 2m	121 EUR
JZSP-CSI02-3-E	CN1 I/O connector with flying lead cable 3m	151 EUR
JUSP-OP05A-1-E	CN3 Digital Operator with connection cable 1m	432 EUR
JZSP-CVS05-A3-E	CN3 Digital Operator convertor cable 0.3m	161 EUR
JZSP-CVS06-02-E	CN7 connection cable for PC 2.5m	113 EUR
JZSP-CVH03-03-E-G5	CN8 Cable with connector for safety functions 3m	60 EUR
2013595-1	CN8 Connector kit for Safety	18 EUR
JZSP-CA01-E	CN5 Cable for Analog Monitor 1m	20 EUR
KLBU 4-13.5 SET	Shielding clamp SET for motor cable 4-13.5mm <sup>2</sup> for Servopacks: Sigma 7 200V up to 750W, Sigma-5 200V up to 750W	10 EUR
KLBU 4-13.5 SC	Shielding clamp for motor cable 4-13.5mm <sup>2</sup> for Servopacks: Sigma 7 400V up to 3.0 kW, Sigma 7 200V 1.5 kW 1ph, Sigma 5 200V 1.5 kW 1ph	7 EUR
SGDV-OCA01A	EtherCAT I/F Option Card Sigma-5	524 EUR
SGDV-OCA03A	Indexer I/F Option Card Sigma-5	438 EUR
SGDV-OCA04A	DeviceNet I/F Option Card Sigma-5	699 EUR
SGDV-OCA05A	DeviceNet I/F Option Card Sigma-5 w/ external Power Supply	834 EUR
SGDV-OCB01A	CANopen I/F Option Card Sigma-5	514 EUR
SGDV-OCB02A	Powerlink I/F Option Card Sigma-5	595 EUR
SGDV-OCB03A	PROFINET I/F Network Module	383 EUR
SGDV-OFA01A	Fully-closed Loop Option Card Sigma-5	81 EUR
SGDV-OFB01A	Option Feedback Module for EnDat-2.1, EnDat-2.2, Hiperface, Sin/Cos	350 EUR
SGDV-OFB03A	Option Feedback Module for TTL Encoder incl. Cover	400 EUR
SGDV-OFB04A	Option Feedback Module for Resolver encoder incl. Cover	425 EUR
SGDV-OSA01A	Advanced Safety Option Card	179 EUR
SGDV-OZA01A	Mounting Kit for Sigma-5 Option Cards	46 EUR
VMK-U-MP26A01R001	MP2600iec BOX, 1.5 Axis - Machine Controller Module, incl. Mounting Kit and Battery	1,864 EUR
CBK-U-MP2B-A5	Connector Terminal Converter for I/O Signals, 50-pin, length 0,5m	221 EUR
CBK-U-MP2B-01	Connector Terminal Converter for I/O Signals, 50-pin, length 1,0m	242 EUR
CBK-U-MP2A-01	Connector Terminal Converter for LIO-01/LIO-02 Module, length 1,0m	295 EUR
CBK-U-MP2C-01	Terminal Block Kit for MP3200 I/O, 64-Point I/O Module, 1,0m	513 EUR
DP9420007-E	CN11 I/O Connector kit	42 EUR
JUSP-TA36V-E	CN11 I/O Connector with Terminal Block 0,5m	348 EUR
JUSP-TA36V-1-E	CN11 I/O Connector with Terminal Block 1m	371 EUR
JUSP-TA36V-2-E	CN11 I/O Connector with Terminal Block 2m	383 EUR
JZSP-CVI01-1-E	CN11 I/O connector with flying lead 1m	125 EUR
JZSP-CVI01-2-E	CN11 I/O connector with flying lead 2m	160 EUR
JZSP-CVI01-3-E	CN11 I/O connector with flying lead 3m	181 EUR
JZSP-CHI9-1	Connector for connecting IBM compatible PC	53 EUR
JZSP-CMS02-E	Cable for connecting IBM compatible PC, 9 pin	75 EUR
JUSP-RA18-E	Resistor for Sigma-5 for SGD#-210D+260D Type 400V Servo Amplifier	595 EUR
JUSP-RA19-E	Resistor for Sigma-5 for SGD#-280D+370D Type 400V Servo Amplifier	843 EUR
JZDP-D003-000-E	Serial Converter for external Encoder	564 EUR
JZDP-D005-000-E	Serial Converter for external Encoder	564 EUR
JZSP-CLP70-03-E-G5	CN31 Cable for connecting serial converter for Fully-closed for Sigma-5 (3m)	161 EUR
JZSP-CLP70-05-E-G5	CN31 Cable for connecting serial converter for Fully-closed for Sigma-5 (5m)	200 EUR
JZSP-CLP70-10-E-G5	CN31 Cable for connecting serial converter for Fully-closed for Sigma-5 (10m)	295 EUR
JZSP-CLP70-15-E-G5	CN31 Cable for connecting serial converter for Fully-closed for Sigma-5 (15m)	389 EUR

## Filters for SGD Servopacks

Ürün Kodu	Açıklama	Liste Fiyatı
RF 1005-SG5	Noise Filter for Sigma-5 for SGD-R70A - 2R8A Type 230V Servo Amplifier	77 EUR
RF 1009-SG5-V2	Noise Filter for Sigma-5 for SGD-5R5A Type 230V Servo Amplifier	105 EUR
RF 1016-SG5	Noise Filter for Sigma-5 for SGD-120A Type 230V Servo Amplifier	123 EUR
RF 3004-SG5	Noise Filter for Sigma-5 for SGD-1R9D - 5R4D Type 400V Servo Amplifier	117 EUR
RF 3008-SG5	Noise Filter for Sigma-5 for SGD-8R4D - 120D Type 400V Servo Amplifier	164 EUR
RF 3012-SG5	Noise Filter for Sigma-5 for SGD-170D Type 400V Servo Amplifier	175 EUR
RF 3022-SG5	Noise Filter for Sigma-5 for SGD-210D - 260D Type 400V Servo Amplifier	175 EUR
RF 3044-SG5	Noise Filter for Sigma-5 for SGD-280D - 370D Type 400V Servo Amplifier	220 EUR

## Filters for SGD Servopacks (Combi Filters including control power)

Ürün Kodu	Açıklama	Liste Fiyatı
FESS-B005A	Noise Filter for Sigma-5 1ph for SGD-R70A - 2R8A Type 230V Servo Amplifier	91 EUR
FESS-B009A	Noise Filter for Sigma-5 1ph for SGD-5R5A & 7R6A Type 230V Servo Amplifier	119 EUR
FESS-B016A	Noise Filter for Sigma-5 1ph for SGD-120A Type 230V Servo Amplifier	179 EUR

## Reactors for SGD Servopacks

Ürün Kodu	Açıklama	Liste Fiyatı
X5059	DC Reactors for Sigma-5 for SGD-200A Type 230V Servo Amplifier	258 EUR
X5060	DC Reactors for Sigma-5 for SGD-120A - 180A Type 230V Servo Amplifier	238 EUR
X5061	DC Reactors for Sigma-5 for SGD-R70A - 7R6A Type 230V Servo Amplifier	228 EUR
X5068	DC Reactors for Sigma-5 for SGD-330A Type 230V Servo Amplifier	318 EUR
X5074	DC Reactors for Sigma-5 for SGD-1R9D Type 400V Servo Amplifier	203 EUR
X5075	DC Reactors for Sigma-5 for SGD-3R5D - 5R4D Type 400V Servo Amplifier	260 EUR
X5076	DC Reactors for Sigma-5 for SGD-8R4D - 120D Type 400V Servo Amplifier	391 EUR
X5077	DC Reactors for Sigma-5 for SGD-170D Type 400V Servo Amplifier	453 EUR



## Servopack Sigma V - Other Network Type for Large Capacity Motors

@ 3ph 270 to 310 VDC, 50/60Hz, +10%/-15%, 22kW - 37kW  
 @ 3ph 520 to 650 VDC, 50/60Hz, +10%/-15%, 30kW - 55kW  
 @ UL-, CE-conform, RoHS-conform

### Other Network Type Large Capacity SERVOPACK SGD-####E1

Ürün Kodu	Açıklama	Liste Fiyatı
SGDV-121HE1A	Sigma 5 Servo Amplifier 22kW 3ph 200V Analog/Pulse	7.239 EUR
SGDV-161HE1A	Sigma 5 Servo Amplifier 30kW 3ph 200V Analog/Pulse	7.705 EUR
SGDV-201HE1A	Sigma 5 Servo Amplifier 37kW 3ph 200V Analog/Pulse	10.637 EUR
SGDV-750JE1A	Sigma 5 Servo Amplifier 30kW 3ph 400V Other Network Type	6.256 EUR
SGDV-101JE1A	Sigma 5 Servo Amplifier 37kW 3ph 400V Other Network Type	6.567 EUR
SGDV-131JE1A	Sigma 5 Servo Amplifier 55kW 3ph 400V Other Network Type	10.045 EUR

### Converter for Other Network Type Large Capacity SERVOPACK SGD-####E1

Ürün Kodu	Açıklama	Liste Fiyatı
SGDV-COA3ZDA	Converter for Sigma 5 LC 30kW 400V	5.872 EUR
SGDV-COA5EDA	Converter for Sigma 5 LC 55kW 400V	8.649 EUR

### Other Network Type Large Capacity SERVOPACK Accessories SGD-####E1

Ürün Kodu	Açıklama	Liste Fiyatı
HF3150C-UQB	Noise filter 400V, 150 Amps for SGD-750J / -101J	3.096 EUR
HF3200C-UQB	Noise filter 400V, 200 Amps for SGD-131J	3.553 EUR
JZSP-CSI9-1-E	CN1 Connector Kit for I/O signal	53 EUR
JUSP-TA50PG-E	CN1 I/O Connector with Terminal Block 0.5m	348 EUR
JUSP-TA50PG-1-E	CN1 I/O Connector with Terminal Block 1m	443 EUR
JUSP-TA50PG-2-E	CN1 I/O Connector with Terminal Block 2m	449 EUR
JZSP-CSI01-1-E	CN1 I/O connector with flying lead cable 1m	125 EUR
JZSP-CSI01-2-E	CN1 I/O connector with flying lead cable 2m	149 EUR
JZSP-CSI01-3-E	CN1 I/O connector with flying lead cable 3m	158 EUR
JUSP-OP05A-1-E	CN3 Digital Operator with connection cable 1m	432 EUR
JZSP-CVG00-A4-E	Control Power Cable between Servopack and Converter (24V)	36 EUR
JZSP-CVI02-A4-E	I/O Signal Cable between Servopack and Converter (24V)	328 EUR
JZSP-CVS05-A3-E	CN3 Digital Operator convertor cable 0.3m	161 EUR
JZSP-CVS06-02-E	CN7 connection cable for PC 2.5m	113 EUR
JZSP-CA01-E	CN5 Cable for Analog Monitor 1m	20 EUR
JZSP-CVH03-03-E-G5	CN8 Cable with connector for safety functions 3m	60 EUR
2013595-1	Safety Connector Kit for CN 8	18 EUR
JZSP-CVD00-1A5-E	CN115 Dynamic Brake Unit Connection Cable (1.5m) Servopack end (only for Sigma V Large Capacity)	44 EUR
JZSP-CVD00-03-E	CN115 Dynamic Brake Unit Connection Cable (3m) Servopack end (only for Sigma V Large Capacity)	51 EUR
JUSP-DB02-E	Dynamic Brake Unit 180 W, 0.3 Ohm x 3 (for SGD-121H, 161H, 201H)	Sorunuz
JUSP-DB04-E	Dynamic Brake Unit 180 W, 0.8 Ohm x 3 (for SGD-750J, 101J)	1.514 EUR
JUSP-DB06-E	Dynamic Brake Unit 300 W, 0.8 Ohm x 3 (for SGD-131J)	1.823 EUR
SGDV-OCA01A	EtherCAT I/F Option Card Sigma-5	524 EUR
SGDV-OCB02A	Powerlink I/F Option Card Sigma-5	595 EUR
SGDV-OCB03A	PROFINET I/F Network Module	383 EUR
SGDV-OCA03A	Indexer I/F Option Card Sigma-5	438 EUR
SGDV-OCA04A	DeviceNet I/F Option Card Sigma-5	699 EUR
SGDV-OCA05A	DeviceNet I/F Option Card Sigma-5 w/ external Power Supply	834 EUR
SGDV-OA01A	Advanced Safety Option Card	179 EUR
SGDV-OFA01A	Fully-closed Loop Option Card Sigma-5	81 EUR



## Low Inertia & Ultra Small Capacity Servomotor Sigma V Series (SGMMV)

- @ Power supply voltage: 24/48V DC Voltage Type, 230V AC Voltage Type
- @ Available Power: Flange Size 15mm x 15mm: 3,3 – 11 W, Flange Size 25mm x 25mm: 10 – 30 W
- @ Speed: Rated Speed: 3000 rpm, Maximum Speed 6000 rpm
- @ Encoder: High resolution 17-bit encoder
- @ Options: With holding brake (24V DC, flange size: 25x25mm)

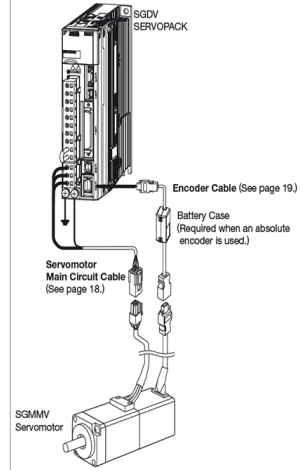

### SGMMV Low Inertia & Ultra Small Capacity Servomotor with 17-bit Absolut Encoder 200V for SGD-R90A & -1R6A

Ürün Kodu	Açıklama	Liste Fiyatı
SGMMV-A1A2A21	AC Motor 200V 1ph,10W (0.0318Nm rated,0.0955Nm peak) 17bit AbsEnc	548 EUR
SGMMV-A2A2A21	AC Motor 200V 1ph,20W (0.0637Nm rated,0.191Nm peak) 17bit AbsEnc	591 EUR
SGMMV-A3A2A21	AC Motor 200V 1ph,30W (0.0955Nm rated,0.286Nm peak) 17bit AbsEnc	651 EUR

### SGMMV Low Inertia & Ultra Small Capacity Servomotor with 17-bit Absolut Encoder 200V + Brake for SGD-R90A & -1R6A

Ürün Kodu	Açıklama	Liste Fiyatı
SGMMV-A1A2A2C	AC Motor 200V 1ph,10W(0.0318Nm rated,0.0955Nm peak)17bit AbsEnc,Brake	898 EUR
SGMMV-A2A2A2C	AC Motor 200V 1ph,20W(0.0637Nm rated,0.191Nm peak)17bit AbsEnc,Brake	1.154 EUR
SGMMV-A3A2A2C	AC Motor 200V 1ph,30W(0.0955Nm rated,0.286Nm peak)17bit AbsEnc,Brake	884 EUR

### Servo Motor Power Cable Standard Type for SGMMV 200V

Ürün Kodu	Açıklama	Liste Fiyatı
JZSP-CF2M00-03-E	Standard Power cable(3m) for SGMMV 200V	63 EUR
JZSP-CF2M00-05-E	Standard Power cable(5m) for SGMMV 200V	83 EUR
JZSP-CF2M00-10-E	Standard Power cable(10m) for SGMMV 200V	133 EUR
JZSP-CF2M00-15-E	Standard Power cable(15m) for SGMMV 200V	184 EUR
JZSP-CF2M00-20-E	Standard Power cable(20m) for SGMMV 200V	234 EUR

### Servo Motor Power Cable Flexible Type for SGMMV 200V

Ürün Kodu	Açıklama	Liste Fiyatı
JZSP-CF2M20-03-E	Flexible Power cable(3m) for SGMMV 200V	90 EUR
JZSP-CF2M20-05-E	Flexible Power cable(5m) for SGMMV 200V	128 EUR
JZSP-CF2M20-10-E	Flexible Power cable(10m) for SGMMV 200V	229 EUR
JZSP-CF2M20-15-E	Flexible Power cable(15m) for SGMMV 200V	328 EUR
JZSP-CF2M20-20-E	Flexible Power cable(20m) for SGMMV 200V	428 EUR

### Servo Motor Power Cable Standard Type + Brake for SGMMV 200V

Ürün Kodu	Açıklama	Liste Fiyatı
JZSP-CF2M03-03-E	Standard Power + Brake cable(3m) for SGMMV 200V	70 EUR
JZSP-CF2M03-05-E	Standard Power + Brake cable(5m) for SGMMV 200V	90 EUR
JZSP-CF2M03-10-E	Standard Power + Brake cable(10m) for SGMMV 200V	142 EUR
JZSP-CF2M03-15-E	Standard Power + Brake cable(15m) for SGMMV 200V	192 EUR
JZSP-CF2M03-20-E	Standard Power + Brake cable(20m) for SGMMV 200V	243 EUR

## Servo Motor Power Cable Flexible Type + Brake for SGMMV 200V

Ürün Kodu	Açıklama	Liste Fiyatı
JZSP-CF2M23-03-E	Flexible Power + Brake cable(3m) for SGMMV 200V	114 EUR
JZSP-CF2M23-05-E	Flexible Power + Brake cable(5m) for SGMMV 200V	164 EUR
JZSP-CF2M23-10-E	Flexible Power + Brake cable(10m) for SGMMV 200V	295 EUR
JZSP-CF2M23-15-E	Flexible Power + Brake cable(15m) for SGMMV 200V	423 EUR
JZSP-CF2M23-20-E	Flexible Power + Brake cable(20m) for SGMMV 200V	549 EUR

## SGMMV Low Inertia & Ultra Small Capacity Servomotor with 17-bit Absolut Encoder 24VDC / 48VDC for SGDV-1R7E & -2R9E

Ürün Kodu	Açıklama	Liste Fiyatı
SGMMV-B3E2A21	AC Motor 24VDC/48VDC,3.3W(0.0105Nm rated,0.0263Nm peak)17bit AbsEnc	661 EUR
SGMMV-B5E2A21	AC Motor 24VDC/48VDC,5.5W(0.0175Nm rated,0.0438Nm peak)17bit AbsEnc	708 EUR
SGMMV-B9E2A21	AC Motor 24VDC/48VDC,11W(0.0350Nm rated,0.0875Nm peak)17bit AbsEnc	791 EUR
SGMMV-A1E2A21	AC Motor 24VDC/48VDC,10W(0.0318Nm rated,0.0955Nm peak)17bit AbsEnc	647 EUR
SGMMV-A2E2A21	AC Motor 24VDC/48VDC,20W(0.0637Nm rated,0.191Nm peak)17bit AbsEnc	591 EUR
SGMMV-A3E2A21	AC Motor 24VDC/48VDC,30W(0.0955Nm rated,0.286Nm peak)17bit AbsEnc	651 EUR

## SGMMV Low Inertia & Ultra Small Capacity Servomotor with 17-bit Absolut Encoder 24VDC / 48VDC + Brake for SGDV-1R7E & -2R9E

Ürün Kodu	Açıklama	Liste Fiyatı
SGMMV-A1E2A2C	AC Motor 24VDC / 48VDC,10W (0.0318Nm rated,0.0955Nm peak) 17bit AbsEnc, Brake	898 EUR
SGMMV-A2E2A2C	AC Motor 24VDC / 48VDC,20W (0.0637Nm rated,0.191Nm peak) 17bit AbsEnc, Brake	950 EUR
SGMMV-A3E2A2C	AC Motor 24VDC / 48VDC,30W (0.0955Nm rated,0.286Nm peak) 17bit AbsEnc, Brake	884 EUR

## Servo Motor Power Cable Standard Type for SGMMV 24VDC / 48VDC

Ürün Kodu	Açıklama	Liste Fiyatı
JZSP-CF1M00-03-E	Standard Power cable(3m) for SGMMV 24VDC / 48VDC	65 EUR
JZSP-CF1M00-05-E	Standard Power cable(5m) for SGMMV 24VDC / 48VDC	86 EUR
JZSP-CF1M00-10-E	Standard Power cable(10m) for SGMMV 24VDC / 48VDC	137 EUR
JZSP-CF1M00-15-E	Standard Power cable(15m) for SGMMV 24VDC / 48VDC	187 EUR
JZSP-CF1M00-20-E	Standard Power cable(20m) for SGMMV 24VDC / 48VDC	238 EUR

## Servo Motor Power Cable Flexible Type for SGMMV 24VDC / 48VDC

Ürün Kodu	Açıklama	Liste Fiyatı
JZSP-CF1M20-03-E	Flexible Power cable(3m) for SGMMV 24VDC / 48VDC	101 EUR
JZSP-CF1M20-05-E	Flexible Power cable(5m) for SGMMV 24VDC / 48VDC	145 EUR
JZSP-CF1M20-10-E	Flexible Power cable(10m) for SGMMV 24VDC / 48VDC	257 EUR
JZSP-CF1M20-15-E	Flexible Power cable(15m) for SGMMV 24VDC / 48VDC	368 EUR
JZSP-CF1M20-20-E	Flexible Power cable(20m) for SGMMV 24VDC / 48VDC	479 EUR

## Servo Motor Power Cable Standard Type + Brake for SGMMV 24VDC / 48VDC

Ürün Kodu	Açıklama	Liste Fiyatı
JZSP-CF1M10-03-E	Standard Power + Brake cable(3m) for SGMMV 24VDC / 48VDC	73 EUR
JZSP-CF1M10-05-E	Standard Power + Brake cable(5m) for SGMMV 24VDC / 48VDC	93 EUR
JZSP-CF1M10-10-E	Standard Power + Brake cable(10m) for SGMMV 24VDC / 48VDC	145 EUR
JZSP-CF1M10-15-E	Standard Power + Brake cable(15m) for SGMMV 24VDC / 48VDC	195 EUR
JZSP-CF1M10-20-E	Standard Power + Brake cable(20m) for SGMMV 24VDC / 48VDC	246 EUR

## Servo Motor Power Cable Flexible Type + Brake for SGMMV 24VDC / 48VDC

Ürün Kodu	Açıklama	Liste Fiyatı
JZSP-CF1M30-03-E	Flexible Power + Brake cable(3m) for SGMMV 24VDC / 48VDC	129 EUR
JZSP-CF1M30-05-E	Flexible Power + Brake cable(5m) for SGMMV 24VDC / 48VDC	186 EUR
JZSP-CF1M30-10-E	Flexible Power + Brake cable(10m) for SGMMV 24VDC / 48VDC	332 EUR
JZSP-CF1M30-15-E	Flexible Power + Brake cable(15m) for SGMMV 24VDC / 48VDC	473 EUR
JZSP-CF1M30-20-E	Flexible Power + Brake cable(20m) for SGMMV 24VDC / 48VDC	616 EUR

## Absolute Encoder Cable Standard Type for SGMMV 200V + 24VDC / 48VDC

Ürün Kodu	Açıklama	Liste Fiyatı
JZSP-CSP19-03-E	Standard Absolute Encoder cable(3m) for SGMMV 200V + 24VDC / 48VDC	246 EUR
JZSP-CSP19-05-E	Standard Absolute Encoder cable(5m) for SGMMV 200V + 24VDC / 48VDC	273 EUR
JZSP-CSP19-10-E	Standard Absolute Encoder cable(10m) for SGMMV 200V + 24VDC / 48VDC	336 EUR
JZSP-CSP19-15-E	Standard Absolute Encoder cable(15m) for SGMMV 200V + 24VDC / 48VDC	416 EUR
JZSP-CSP19-20-E	Standard Absolute Encoder cable(20m) for SGMMV 200V + 24VDC / 48VDC	493 EUR

## Absolute Encoder Cable Flexible Type for SGMMV 200V + 24VDC / 48VDC

Ürün Kodu	Açıklama	Liste Fiyatı
JZSP-CSP29-03-E	Flexible Absolute Encoder cable(3m) for SGMMV 200V + 24VDC / 48VDC	282 EUR
JZSP-CSP29-05-E	Flexible Absolute Encoder cable(5m) for SGMMV 200V + 24VDC / 48VDC	305 EUR
JZSP-CSP29-10-E	Flexible Absolute Encoder cable(10m) for SGMMV 200V + 24VDC / 48VDC	373 EUR
JZSP-CSP29-15-E	Flexible Absolute Encoder cable(15m) for SGMMV 200V + 24VDC / 48VDC	419 EUR
JZSP-CSP29-20-E	Flexible Absolute Encoder cable(20m) for SGMMV 200V + 24VDC / 48VDC	590 EUR

## Encoder Connector Kit for SGMMV 200V + 24VDC / 48VDC

Ürün Kodu	Açıklama	Liste Fiyatı
JZSP-CMP9-1-E-G1	Connector Kit Encoder for CN2 Servopack end	20 EUR
JZSP-CMP9-2-E	Encoder-end Connector Kit	36 EUR



## Low Inertia Servomotor Sigma V Series (SGMAV)

- @ 0.05 - 1.00kW
- @ 230V
- @ 3.000 rpm rated speed, 6.000 rpm max. speed
- @ 0.159-3.18 Nm rated torque
- @ Optional 24VDC holding brake
- @ Special Oil Seal optional
- @ IP65 (except for shaft opening)
- @ CE certified, cULus-listed and RoHS conform

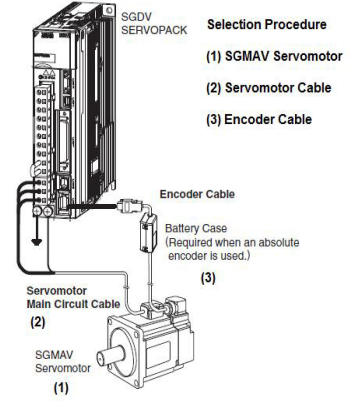

### SGMAV Low Inertia Servo motor with 20-bit incremental Encoder

Ürün Kodu	Açıklama	Liste Fiyatı
SGMAV-A5ADA61	AC Motor 230V 3ph,0.05kW (0.159Nm rated,0.557Nm peak) 20bit IncEnc	629 EUR
SGMAV-01ADA61	AC Motor 230V 3ph,0.10kW (0.318Nm rated,1.11Nm peak) 20bit IncEnc	651 EUR
SGMAV-C2ADA61	AC Motor 230V 3ph,0.15KW (0.477Nm rated,1.43Nm peak) 20bit IncEnc	699 EUR
SGMAV-02ADA61	AC Motor 230V 3ph,0.20KW (0.637Nm rated,1.91Nm peak) 20bit IncEnc	765 EUR
SGMAV-04ADA61	AC Motor 230V 3ph,0.40KW (1.27Nm rated, 3.82Nm peak) 20bit IncEnc	911 EUR
SGMAV-06ADA61	AC Motor 230V 3ph,0.55KW (1.75Nm rated, 5.25Nm peak) 20bit IncEnc	991 EUR
SGMAV-08ADA61	AC Motor 230V 3ph,0.75kW (2.39Nm rated,7.16Nm peak) 20bit IncEnc	1.102 EUR
SGMAV-10ADA61	AC Motor 230V 3ph,1.00kW (3.18Nm rated,9.55Nm peak) 20bit IncEnc	1.150 EUR

### SGMAV Low Inertia Servo motor with 20-bit incremental Encoder + Brake

Ürün Kodu	Açıklama	Liste Fiyatı
SGMAV-A5ADA6C	AC Motor 230V 3ph,0.05kW (0.159Nm rated,0.557Nm peak) 20bit IncEnc, Brake	924 EUR
SGMAV-01ADA6C	AC Motor 230V 3ph,0.10kW (0.318Nm rated,1.11Nm peak) 20bit IncEnc, Brake	968 EUR
SGMAV-C2ADA6C	AC Motor 230V 3ph,0.15KW (0.477Nm rated,1.43Nm peak) 20bit IncEnc, Brake	1.031 EUR
SGMAV-02ADA6C	AC Motor 230V 3ph,0.20KW (0.637Nm rated,1.91Nm peak) 20bit IncEnc, Brake	1.105 EUR
SGMAV-04ADA6C	AC Motor 230V 3ph,0.40KW (1.27Nm rated, 3.82Nm peak) 20bit IncEnc, Brake	1.268 EUR
SGMAV-06ADA6C	AC Motor 230V 3ph,0.55KW (1.75Nm rated, 5.25Nm peak) 20bit IncEnc, Brake	1.404 EUR
SGMAV-08ADA6C	AC Motor 230V 3ph,0.75kW (2.39Nm rated,7.16Nm peak) 20bit IncEnc, Brake	1.518 EUR
SGMAV-10ADA6C	AC Motor 230V 3ph,1.00kW (3.18Nm rated,9.55Nm peak) 20bit IncEnc, Brake	1.568 EUR

### SGMAV Low Inertia Servo motor with 20-bit Absolute Encoder

Ürün Kodu	Açıklama	Liste Fiyatı
SGMAV-A5A3A61	AC Motor 230V 3ph,0.05kW (0.159Nm rated,0.557Nm peak) 20bit AbsEnc	768 EUR
SGMAV-01A3A61	AC Motor 230V 3ph,0.10kW (0.318Nm rated,1.11Nm peak) 20bit AbsEnc	790 EUR
SGMAV-C2A3A61	AC Motor 230V 3ph,0.15KW (0.477Nm rated,1.43Nm peak) 20bit AbsEnc	837 EUR
SGMAV-02A3A61	AC Motor 230V 3ph,0.20KW (0.637Nm rated,1.91Nm peak) 20bit AbsEnc	902 EUR
SGMAV-04A3A61	AC Motor 230V 3ph,0.40KW (1.27Nm rated, 3.82Nm peak) 20bit AbsEnc	1.053 EUR
SGMAV-06A3A61	AC Motor 230V 3ph,0.55KW (1.75Nm rated, 5.25Nm peak) 20bit AbsEnc	1.139 EUR
SGMAV-08A3A61	AC Motor 230V 3ph,0.75kW (2.39Nm rated,7.16Nm peak) 20bit AbsEnc	1.240 EUR
SGMAV-10A3A61	AC Motor 230V 3ph,1.00kW (3.18Nm rated,9.55Nm peak) 20bit AbsEnc	1.288 EUR

### SGMAV Low Inertia Servo motor with 20-bit Absolute Encoder + Brake

Ürün Kodu	Açıklama	Liste Fiyatı
SGMAV-A5A3A6C	AC Motor 230V 3ph,0.05kW (0.159Nm rated,0.557Nm peak) 20bit AbsEnc, Brake	1.066 EUR
SGMAV-01A3A6C	AC Motor 230V 3ph,0.10kW (0.318Nm rated,1.11Nm peak) 20bit AbsEnc, Brake	1.105 EUR
SGMAV-C2A3A6C	AC Motor 230V 3ph,0.15KW (0.477Nm rated,1.43Nm peak) 20bit AbsEnc, Brake	1.169 EUR
SGMAV-02A3A6C	AC Motor 230V 3ph,0.20KW (0.637Nm rated,1.91Nm peak) 20bit AbsEnc, Brake	1.247 EUR
SGMAV-04A3A6C	AC Motor 230V 3ph,0.40KW (1.27Nm rated, 3.82Nm peak) 20bit AbsEnc, Brake	1.409 EUR
SGMAV-06A3A6C	AC Motor 230V 3ph,0.55KW (1.75Nm rated, 5.25Nm peak) 20bit AbsEnc, Brake	1.627 EUR
SGMAV-08A3A6C	AC Motor 230V 3ph,0.75kW (2.39Nm rated,7.16Nm peak) 20bit AbsEnc, Brake	1.656 EUR
SGMAV-10A3A6C	AC Motor 230V 3ph,1.00kW (3.18Nm rated,9.55Nm peak) 20bit AbsEnc, Brake	1.706 EUR

Please note that Yaskawa has got also Servo Motors with special Oil Seal or Motors without Keyway in the product portfolio which can be quoted on demand !



## Medium Inertia Servomotor Sigma V Series (SGMJV)



- @ 0.05 - 0.75kW
- @ 230V
- @ 3.000 rpm rated speed, 6.000 rpm max. speed
- @ 0.159-2.39 Nm rated torque
- @ Optional 24VDC holding brake
- @ Special Oil Seal optional
- @ IP65 (except for shaft opening)
- @ CE certified, cULus-listed and RoHS conform

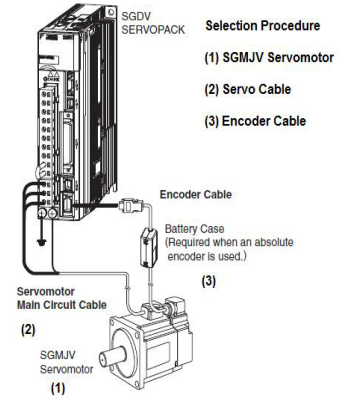

### SGMJV Medium Inertia Servo motor with 13-bit incremental Encoder

Ürün Kodu	Açıklama	Liste Fiyatı
SGMJV-A5AAA61	AC Motor 230V 3ph, 0.05kW (0.159Nm rated, 0.557Nm peak) 13bit IncEnc	527 EUR
SGMJV-01AAA61	AC Motor 230V 3ph, 0.10kW (0.318Nm rated, 1.11Nm Peak) 13bit IncEnc	546 EUR
SGMJV-02AAA61	AC Motor 230V 3ph, 0.20kW (0.637Nm rated, 2.23Nm Peak) 13bit IncEnc	633 EUR
SGMJV-04AAA61	AC Motor 230V 3ph, 0.40kW (1.27Nm rated, 4.46Nm peak) 13bit IncEnc	775 EUR
SGMJV-08AAA61	AC Motor 230V 3ph, 0.75kW (2.39Nm rated, 8.36Nm peak) 13bit IncEnc	797 EUR

### SGMJV Medium Inertia Servo motor with 20-bit incremental Encoder

Ürün Kodu	Açıklama	Liste Fiyatı
SGMJV-A5ADA61	AC Motor 230V 3ph, 0.05kW (0.159Nm rated, 0.557Nm peak) 20bit IncEnc	629 EUR
SGMJV-01ADA61	AC Motor 230V 3ph, 0.10kW (0.318Nm rated, 1.11Nm Peak) 20bit IncEnc	651 EUR
SGMJV-02ADA61	AC Motor 230V 3ph, 0.20kW (0.637Nm rated, 2.23Nm Peak) 20bit IncEnc	765 EUR
SGMJV-04ADA61	AC Motor 230V 3ph, 0.40kW (1.27Nm rated, 4.46Nm peak) 20bit IncEnc	911 EUR
SGMJV-08ADA61	AC Motor 230V 3ph, 0.75kW (2.39Nm rated, 8.36Nm peak) 20bit IncEnc	1.102 EUR

### SGMJV Medium Inertia Servo motor with 13-bit incremental Encoder + Brake

Ürün Kodu	Açıklama	Liste Fiyatı
SGMJV-A5AAA6C	AC Motor 230V 3ph, 0.05kW (0.159Nm rated, 0.557Nm peak) 13bit IncEnc, Brake	772 EUR
SGMJV-01AAA6C	AC Motor 230V 3ph, 0.10kW (0.318Nm rated, 1.11Nm Peak) 13bit IncEnc, Brake	805 EUR
SGMJV-02AAA6C	AC Motor 230V 3ph, 0.20kW (0.637Nm rated, 2.23Nm Peak) 13bit IncEnc, Brake	920 EUR
SGMJV-04AAA6C	AC Motor 230V 3ph, 0.40kW (1.27Nm rated, 4.46Nm peak) 13bit IncEnc, Brake	1.053 EUR
SGMJV-08AAA6C	AC Motor 230V 3ph, 0.75kW (2.39Nm rated, 8.36Nm peak) 13bit IncEnc, Brake	1.341 EUR

### SGMJV Medium Inertia Servo motor with 20-bit incremental Encoder + Brake

Ürün Kodu	Açıklama	Liste Fiyatı
SGMJV-A5ADA6C	AC Motor 230V 3ph, 0.05kW (0.159Nm rated, 0.557Nm peak) 20bit IncEnc, Brake	924 EUR
SGMJV-01ADA6C	AC Motor 230V 3ph, 0.10kW (0.318Nm rated, 1.11Nm Peak) 20bit IncEnc, Brake	968 EUR
SGMJV-02ADA6C	AC Motor 230V 3ph, 0.20kW (0.637Nm rated, 2.23Nm Peak) 20bit IncEnc, Brake	1.105 EUR
SGMJV-04ADA6C	AC Motor 230V 3ph, 0.40kW (1.27Nm rated, 4.46Nm peak) 20bit IncEnc, Brake	1.268 EUR
SGMJV-08ADA6C	AC Motor 230V 3ph, 0.75kW (2.39Nm rated, 8.36Nm peak) 20bit IncEnc, Brake	1.609 EUR

## SGMJV Medium Inertia Servo motor with 20-bit Absolute Encoder

Ürün Kodu	Açıklama	Liste Fiyatı
SGMJV-A5A3A61	AC Motor 230V 3ph, 0.05kW (0.159Nm rated, 0.557Nm peak) 20Bit AbsEnc	768 EUR
SGMJV-01A3A61	AC Motor 230V 3ph, 0.10kW (0.318Nm rated, 1.11Nm Peak) 20bit AbsEnc	790 EUR
SGMJV-02A3A61	AC Motor 230V 3ph, 0.20kW (0.637Nm rated, 2.23Nm Peak) 20bit AbsEnc	902 EUR
SGMJV-04A3A61	AC Motor 230V 3ph, 0.40kW (1.27Nm rated, 4.46Nm peak) 20bit AbsEnc	1.023 EUR
SGMJV-08A3A61	AC Motor 230V 3ph, 0.75kW (2.39Nm rated, 8.36Nm peak) 20bit AbsEnc	1.240 EUR

## SGMJV Medium Inertia Servo motor with 20-bit Absolute Encoder + Brake

Ürün Kodu	Açıklama	Liste Fiyatı
SGMJV-A5A3A6C	AC Motor 230V 3ph, 0.05kW(0.159Nm rated, 0.557Nm peak)20bit AbsEnc, Brake	1.066 EUR
SGMJV-01A3A6C	AC Motor 230V 3ph, 0.10kW(0.318Nm rated, 1.11Nm Peak)20bit AbsEnc, Brake	1.105 EUR
SGMJV-02A3A6C	AC Motor 230V 3ph, 0.20kW(0.637Nm rated, 2.23Nm Peak)20bit AbsEnc, Brake	1.247 EUR
SGMJV-04A3A6C	AC Motor 230V 3ph, 0.40kW(1.27Nm rated, 4.46Nm peak)20bit AbsEnc, Brake	1.368 EUR
SGMJV-08A3A6C	AC Motor 230V 3ph, 0.75kW(2.39Nm rated, 8.36Nm peak)20bit AbsEnc, Brake	1.656 EUR

Please note that Yaskawa has got also Servo Motors with special Oil Seal or Motors without Keyway in the product portfolio which can be quoted on demand !

## Servo Motor Power Cable flexible type 0.05 to 1.00kW SGMJV/JV

Ürün Kodu	Açıklama	Liste Fiyatı
JZSP-CSM21-03-E-G5	Flexible Power cable(3m) for SGMJV/JV(0.05-0.15kW)	105 EUR
JZSP-CSM21-05-E-G5	Flexible Power cable(5m) for SGMJV/JV(0.05-0.15kW)	125 EUR
JZSP-CSM21-10-E-G5	Flexible Power cable(10m) for SGMJV/JV(0.05-0.15kW)	172 EUR
JZSP-CSM21-15-E-G5	Flexible Power cable(15m) for SGMJV/JV(0.05-0.15kW)	220 EUR
JZSP-CSM21-20-E-G5	Flexible Power cable(20m) for SGMJV/JV(0.05-0.15kW)	270 EUR
JZSP-CSM22-03-E-G5	Flexible Power cable(3m) for SGMJV/JV(0.20-0.55kW)	105 EUR
JZSP-CSM22-05-E-G5	Flexible Power cable(5m) for SGMJV/JV(0.20-0.55kW)	125 EUR
JZSP-CSM22-10-E-G5	Flexible Power cable(10m) for SGMJV/JV(0.20-0.55kW)	172 EUR
JZSP-CSM22-15-E-G5	Flexible Power cable(15m) for SGMJV/JV(0.20-0.55kW)	220 EUR
JZSP-CSM22-20-E-G5	Flexible Power cable(20m) for SGMJV/JV(0.20-0.55kW)	270 EUR
JZSP-CSM22-30-E-G5	Flexible Power cable(30m) for SGMJV/JV(0.20-0.55kW)	324 EUR
JZSP-CSM23-03-E-G5	Flexible Power cable(3m) for SGMJV/JV(0.75-1.00kW)	133 EUR
JZSP-CSM23-05-E-G5	Flexible Power cable(5m) for SGMJV/JV(0.75-1.00kW)	169 EUR
JZSP-CSM23-10-E-G5	Flexible Power cable(10m) for SGMJV/JV(0.75-1.00kW)	252 EUR
JZSP-CSM23-15-E-G5	Flexible Power cable(15m) for SGMJV/JV(0.75-1.00kW)	339 EUR
JZSP-CSM23-20-E-G5	Flexible Power cable(20m) for SGMJV/JV(0.75-1.00kW)	428 EUR
JZSP-CSM23-30-E-G5	Flexible Power cable(30m) for SGMJV/JV(0.75-1.00kW)	601 EUR

## Servo Motor Power + Brake Cable flexible type 0.05 to 1.00kW SGMJV/JV

Ürün Kodu	Açıklama	Liste Fiyatı
JZSP-CSM31-03-E-G5	Flexible Power + Brake cable(3m) for SGMJV/JV(0.05-0.15kW)	109 EUR
JZSP-CSM31-05-E-G5	Flexible Power + Brake cable(5m) for SGMJV/JV(0.05-0.15kW)	125 EUR
JZSP-CSM31-10-E-G5	Flexible Power + Brake cable(10m) for SGMJV/JV(0.05-0.15kW)	175 EUR
JZSP-CSM31-15-E-G5	Flexible Power + Brake cable(15m) for SGMJV/JV(0.05-0.15kW)	224 EUR
JZSP-CSM31-20-E-G5	Flexible Power + Brake cable(20m) for SGMJV/JV(0.05-0.15kW)	274 EUR
JZSP-CSM32-03-E-G5	Flexible Power + Brake cable(3m) for SGMJV/JV(0.20-0.55kW)	109 EUR
JZSP-CSM32-05-E-G5	Flexible Power + Brake cable(5m) for SGMJV/JV(0.20-0.55kW)	125 EUR
JZSP-CSM32-10-E-G5	Flexible Power + Brake cable(10m) for SGMJV/JV(0.20-0.55kW)	175 EUR
JZSP-CSM32-15-E-G5	Flexible Power + Brake cable(15m) for SGMJV/JV(0.20-0.55kW)	224 EUR
JZSP-CSM32-20-E-G5	Flexible Power + Brake cable(20m) for SGMJV/JV(0.20-0.55kW)	274 EUR
JZSP-CSM32-25-E-G5	Flexible Power + Brake cable(25m) for SGMJV/JV(0.20-0.55kW)	292 EUR
JZSP-CSM32-30-E-G5	Flexible Power + Brake cable(30m) for SGMJV/JV(0.20-0.55kW)	332 EUR
JZSP-CSM32-35-E-G5	Flexible Power + Brake cable(35m) for SGMJV/JV(0.20-0.55kW)	369 EUR
JZSP-CSM33-03-E-G5	Flexible Power + Brake cable(3m) for SGMJV/JV(0.75-1.00kW)	133 EUR
JZSP-CSM33-05-E-G5	Flexible Power + Brake cable(5m) for SGMJV/JV(0.75-1.00kW)	169 EUR
JZSP-CSM33-10-E-G5	Flexible Power + Brake cable(10m) for SGMJV/JV(0.75-1.00kW)	256 EUR
JZSP-CSM33-15-E-G5	Flexible Power + Brake cable(15m) for SGMJV/JV(0.75-1.00kW)	344 EUR
JZSP-CSM33-20-E-G5	Flexible Power + Brake cable(20m) for SGMJV/JV(0.75-1.00kW)	432 EUR

## Servo Motor Connector Kit for SGMAV and SGMJV

Ürün Kodu	Açıklama	Liste Fiyatı
JZSP-CSM9-1-E-G1	Motor connector kit (m) for SGMJV SGMAV (0.05-0.15kW) (Crimping Tool Required)	53 EUR
JZSP-CSM9-2-E-G1	Motor connector kit (m) for SGMJV SGMAV (0.20-0.55kW) (Crimping Tool Required)	56 EUR
JZSP-CSM9-3-E-G1	Motor connector kit (m) for SGMJV SGMAV (0.75-1.00kW) (Crimping Tool Required)	63 EUR

## Incremental Encoder Cable flexible type SGMAV/JV

Ürün Kodu	Açıklama	Liste Fiyatı
JZSP-CSP21-03-E-G5	Flexible Incremental Encoder cable(3m) for SGMAV/JV	103 EUR
JZSP-CSP21-05-E-G5	Flexible Incremental Encoder cable(5m) for SGMAV/JV	113 EUR
JZSP-CSP21-10-E-G5	Flexible Incremental Encoder cable(10m) for SGMAV/JV	155 EUR
JZSP-CSP21-15-E-G5	Flexible Incremental Encoder cable(15m) for SGMAV/JV	182 EUR
JZSP-CSP21-20-E-G5	Flexible Incremental Encoder cable(20m) for SGMAV/JV	230 EUR
JZSP-CSP21-30-E-G5	Flexible Incremental Encoder cable(30m) for SGMAV/JV	319 EUR
JZSP-CSP21-35-E-G5	Flexible Incremental Encoder cable(35m) for SGMAV/JV	356 EUR

## Special Cable for Absolut Encoder

Ürün Kodu	Açıklama	Liste Fiyatı
JZSP-CSP12-E-G5	Extension Encoder cable with Connectors length 0.3m for Abs. Encoder, incl. Battery	100 EUR

## Absolute Encoder Cable flexible type SGMAV/JV

Ürün Kodu	Açıklama	Liste Fiyatı
JZSP-CSP25-03-E-G5	Flexible Absolute Encoder cable(3m) for SGMAV/JV	196 EUR
JZSP-CSP25-05-E-G5	Flexible Absolute Encoder cable(5m) for SGMAV/JV	220 EUR
JZSP-CSP25-10-E-G5	Flexible Absolute Encoder cable(10m) for SGMAV/JV	280 EUR
JZSP-CSP25-15-E-G5	Flexible Absolute Encoder cable(15m) for SGMAV/JV	339 EUR
JZSP-CSP25-20-E-G5	Flexible Absolute Encoder cable(20m) for SGMAV/JV	400 EUR
JZSP-CSP25-25-E-G5	Flexible Absolute Encoder cable(25m) for SGMAV/JV	297 EUR
JZSP-CSP25-30-E-G5	Flexible Absolute Encoder cable(30m) for SGMAV/JV	332 EUR

## Encoder Connector Kit for SGMAV and SGMJV

Ürün Kodu	Açıklama	Liste Fiyatı
JZSP-CMP9-1-E-G1	Connector Kit Encoder for CN2 servopack end	20 EUR
JZSP-CSP9-2-E-G1	Encoder-end Connector Kit	27 EUR

## Safety Cable for Sigma V

Ürün Kodu	Açıklama	Liste Fiyatı
JZSP-CVH03-03-E-G5	Safety cable standard with connector length 3m	60 EUR
JZSP-CVH05-E	Safety Jumper Connector CN8	27 EUR



## Low and Medium Inertia Servomotor Sigma V Series (SGMEV)

- @ 0.10 - 1.50kW
- @ 230V + 400V
- @ 3.000 rpm rated speed, 5.000 rpm max. speed
- @ 0.318-4.77 Nm rated torque (depend on voltage class)
- @ Optional 24VDC holding brake
- @ Special Oil Seal optional
- @ IP55 (optional IP67)
- @ CE certified, cULus-listed and RoHS conform

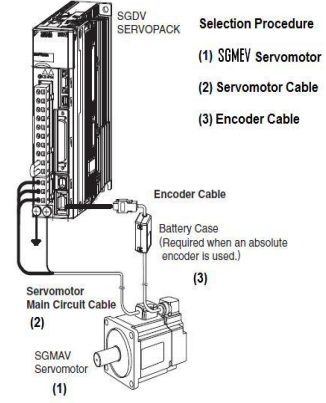

### SGMEV Servo Motor 400V 3ph 20-bit Incremental Encoder

Ürün Kodu	Açıklama	Liste Fiyatı
SGMEV-02DDA61	AC Motor 400V 3ph, 0.20kW(0.637Nm rated,1.91Nm peak) 20bit IncEnc	811 EUR
SGMEV-03DDA61	AC Motor 400V 3ph, 0.30kW(0.955Nm rated,3.82Nm peak) 20bit IncEnc	916 EUR
SGMEV-04DDA61	AC Motor 400V 3ph, 0.40kW(1.27Nm rated,3.82Nm peak) 20bit IncEnc	968 EUR
SGMEV-07DDA61	AC Motor 400V 3ph, 0.65kW(2.07Nm rated,7.16Nm peak) 20bit IncEnc	1.131 EUR
SGMEV-08DDA61	AC Motor 400V 3ph, 0.75kW(2.39Nm rated,7.16Nm peak) 20bit IncEnc	1.146 EUR
SGMEV-15DDA61	AC Motor 400V 3ph, 1.50kW(4.77Nm rated,14.3Nm peak) 20bit IncEnc	1.182 EUR

### SGMEV Servo Motor 400V 3ph 20-bit Incremental Encoder + Brake

Ürün Kodu	Açıklama	Liste Fiyatı
SGMEV-02DDA6C	AC Motor 400V 3ph,0.20kW(0.637Nm rated,1.91Nm peak)20bit IncEnc, Brake	1.073 EUR
SGMEV-03DDA6C	AC Motor 400V 3ph,0.30kW(0.955Nm rated,3.82Nm peak)20bit IncEnc, Brake	1.117 EUR
SGMEV-04DDA6C	AC Motor 400V 3ph,0.40kW(1.27Nm rated,3.82Nm peak)20bit IncEnc, Brake	1.163 EUR
SGMEV-07DDA6C	AC Motor 400V 3ph,0.65kW(2.07Nm rated,7.16Nm peak)20bit IncEnc, Brake	1.364 EUR
SGMEV-08DDA6C	AC Motor 400V 3ph,0.75kW(2.39Nm rated,7.16Nm peak)20bit IncEnc, Brake	1.408 EUR
SGMEV-15DDA6C	AC Motor 400V 3ph,1.50kW(4.77Nm rated,14.3Nm peak)20bit IncEnc, Brake	1.453 EUR

### SGMEV Servo Motor 400V 3ph 20-bit Absolut Encoder

Ürün Kodu	Açıklama	Liste Fiyatı
SGMEV-02D3A61	AC Motor 400V 3ph, 0.20kW(0.637Nm rated,1.91Nm peak) 20bit AbsEnc	950 EUR
SGMEV-03D3A61	AC Motor 400V 3ph, 0.30kW(0.955Nm rated,3.82Nm peak) 20bit AbsEnc	1.056 EUR
SGMEV-04D3A61	AC Motor 400V 3ph, 0.40kW(1.27Nm rated,3.82Nm peak) 20bit AbsEnc	1.105 EUR
SGMEV-07D3A61	AC Motor 400V 3ph, 0.65kW(2.07Nm rated,7.16Nm peak) 20bit AbsEnc	1.271 EUR
SGMEV-08D3A61	AC Motor 400V 3ph, 0.75kW(2.39Nm rated,7.16Nm peak) 20bit AbsEnc	1.284 EUR
SGMEV-15D3A61	AC Motor 400V 3ph, 1.50kW(4.77Nm rated,14.3Nm peak) 20bit AbsEnc	1.321 EUR

### SGMEV Servo Motor 400V 3ph 20-bit Absolut Encoder + Brake

Ürün Kodu	Açıklama	Liste Fiyatı
SGMEV-02D3A6C	AC Motor 400V 3ph,0.20kW(0.637Nm rated,1.91Nm peak)20bit AbsEnc, Brake	1.215 EUR
SGMEV-03D3A6C	AC Motor 400V 3ph,0.30kW(0.955Nm rated,3.82Nm peak)20bit AbsEnc, Brake	1.255 EUR
SGMEV-04D3A6C	AC Motor 400V 3ph,0.40kW(1.27Nm rated,3.82Nm peak)20bit AbsEnc, Brake	1.303 EUR
SGMEV-07D3A6C	AC Motor 400V 3ph,0.65kW(2.07Nm rated,7.16Nm peak)20bit AbsEnc, Brake	1.503 EUR
SGMEV-08D3A6C	AC Motor 400V 3ph,0.75kW(2.39Nm rated,7.16Nm peak)20bit AbsEnc, Brake	1.550 EUR
SGMEV-15D3A6C	AC Motor 400V 3ph,1.50kW(4.77Nm rated,14.3Nm peak)20bit AbsEnc, Brake	1.590 EUR

## SGMEV Servo Motor Power Cable Flexible 400V

Ürün Kodu	Açıklama	Liste Fiyatı
JZSP-CMM20D15-03G	Flexible power cable (3m) for SGMEV 400V (0.10-1.50Kw)	158 EUR
JZSP-CMM20D15-05G	Flexible power cable (5m) for SGMEV 400V (0.10-1.50Kw)	179 EUR
JZSP-CMM20D15-10G	Flexible power cable (10m) for SGMEV 400V (0.10-1.50Kw)	224 EUR
JZSP-CMM20D15-15G	Flexible power cable (15m) for SGMEV 400V (0.10-1.50Kw)	357 EUR
JZSP-CMM20D15-20G	Flexible power cable (20m) for SGMEV 400V (0.10-1.50Kw)	452 EUR

## SGMEV Servo Motor Power + Brake Cable Flexible 400V

Ürün Kodu	Açıklama	Liste Fiyatı
JZSP-CMM30D15-03G	Flexible power + Brake cable (3m) for SGMEV 400V (0.10-1.50Kw)	187 EUR
JZSP-CMM30D15-05G	Flexible power + Brake cable (5m) for SGMEV 400V (0.10-1.50Kw)	232 EUR
JZSP-CMM30D15-10G	Flexible power + Brake cable (10m) for SGMEV 400V (0.10-1.50Kw)	274 EUR
JZSP-CMM30D15-15G	Flexible power + Brake cable (15m) for SGMEV 400V (0.10-1.50Kw)	327 EUR
JZSP-CMM30D15-20G	Flexible power + Brake cable (20m) for SGMEV 400V (0.10-1.50Kw)	379 EUR

## SGMEV Encoder Cable Flexible 400V

Ürün Kodu	Açıklama	Liste Fiyatı
DP9325256-03G	SGMEV Encoder Cable Flexible (3m)	193 EUR
DP9325256-05G	SGMEV Encoder Cable Flexible (5m)	232 EUR
DP9325256-10G	SGMEV Encoder Cable Flexible (10m)	277 EUR
DP9325256-15G	SGMEV Encoder Cable Flexible (15m)	351 EUR
DP9325256-20G	SGMEV Encoder Cable Flexible (20m)	411 EUR

## Special Cable for Absolut Encoder 400V

Ürün Kodu	Açıklama	Liste Fiyatı
JZSP-CSP12-E-G5	Extension Encoder cable with Connectors length 0.3m for Abs. Encoder, incl. Battery	100 EUR

## SGMEV Connectors 400 V

Ürün Kodu	Açıklama	Liste Fiyatı
LPRA06BFRBN170	Motor connector kit (m) for SGMEV (0.10-1.50kW)	90 EUR
SPOC17HFRON169	Encoder connector kit (m) for SGMEV (0.10-1.50kW)	108 EUR

## SGMEV Servo Motor 200V 3ph 20-bit Incremental Encoder

Ürün Kodu	Açıklama	Liste Fiyatı
SGMEV-01ADA61	AC Motor 230V 3ph 0.10kW (0,318Nm rated, 0,955Nm peak) Inc 20bit Enc	577 EUR
SGMEV-02ADA61	AC Motor 230V 3ph 0.20kW (0,637Nm rated, 1,91Nm peak) Inc 20bit Enc	708 EUR
SGMEV-04ADA61	AC Motor 230V 3ph 0.40kW (1,27Nm rated, 3,82Nm peak) Inc 20bit Enc	786 EUR
SGMEV-08ADA61	AC Motor 230V 3ph 0.75kW (2,39Nm rated, 7,16Nm peak) Inc 20bit Enc	1.031 EUR
SGMEV-15ADA61	AC Motor 230V 3ph 1.50kW (4,77Nm rated, 14,3Nm peak) Inc 20bit Enc	1.146 EUR

## SGMEV Servo Motor 200V 3ph 20-bit Incremental Encoder + Brake

Ürün Kodu	Açıklama	Liste Fiyatı
SGMEV-01ADA6C	AC Motor 230V 3ph 0.10kW (0,318Nm rated, 0,955Nm peak) Inc 20bit Enc + Brake	888 EUR
SGMEV-02ADA6C	AC Motor 230V 3ph 0.20kW (0,637Nm rated, 1,91Nm peak) Inc 20bit Enc + Brake	1.009 EUR
SGMEV-04ADA6C	AC Motor 230V 3ph 0.40kW (1,27Nm rated, 3,82Nm peak) Inc 20bit Enc + Brake	1.108 EUR
SGMEV-08ADA6C	AC Motor 230V 3ph 0.75kW (2,39Nm rated, 7,16Nm peak) Inc 20bit Enc + Brake	1.316 EUR
SGMEV-15ADA6C	AC Motor 230V 3ph 1.50kW (4,77Nm rated, 14,3Nm peak) Inc 20bit Enc + Brake	1.461 EUR

## SGMEV Servo Motor 200V 3ph 20-bit Absolut Encoder

Ürün Kodu	Açıklama	Liste Fiyatı
SGMEV-01A3A61	AC Motor 230V 3ph 0.10kW (0,318Nm rated, 0,955Nm peak) Abs 20bit Enc	705 EUR
SGMEV-02A3A61	AC Motor 230V 3ph 0.20kW (0,637Nm rated, 1,91Nm peak) Abs 20bit Enc	832 EUR
SGMEV-04A3A61	AC Motor 230V 3ph 0.40kW (1,27Nm rated, 3,82Nm peak) Abs 20bit Enc	913 EUR
SGMEV-08A3A61	AC Motor 230V 3ph 0.75kW (2,39Nm rated, 7,16Nm peak) Abs 20bit Enc	1.156 EUR
SGMEV-15A3A61	AC Motor 230V 3ph 1.50kW (4,77Nm rated, 14,3Nm peak) Abs 20bit Enc	1.274 EUR

## SGMEV Servo Motor 200V 3ph 20-bit Absolut Encoder + Brake

Ürün Kodu	Açıklama	Liste Fiyatı
SGMEV-01A3A6C	AC Motor 230V 3ph 0.10kW (0,318Nm rated, 0,955Nm peak) Abs 20bit Enc + Brake	1.052 EUR
SGMEV-02A3A6C	AC Motor 230V 3ph 0.20kW (0,637Nm rated, 1,91Nm peak) Abs 20bit Enc + Brake	1.189 EUR
SGMEV-04A3A6C	AC Motor 230V 3ph 0.40kW (1,27Nm rated, 3,82Nm peak) Abs 20bit Enc + Brake	1.272 EUR
SGMEV-08A3A6C	AC Motor 230V 3ph 0.75kW (2,39Nm rated, 7,16Nm peak) Abs 20bit Enc + Brake	1.622 EUR
SGMEV-15A3A6C	AC Motor 230V 3ph 1.50kW (4,77Nm rated, 14,3Nm peak) Abs 20bit Enc + Brake	1.752 EUR

Please note that Yaskawa has got also Servo Motors with special Oil Seal or Motors without Keyway in the product portfolio which can be quoted on demand !

## SGMEV Servo Motor Power Cable Flexible 200V

Ürün Kodu	Açıklama	Liste Fiyatı
DP9325252-03G	Flexible power cable (3m) for SGMEV 200V (0.10-0.75Kw)	133 EUR
DP9325252-05G	Flexible power cable (5m) for SGMEV 200V (0.10-0.75Kw)	161 EUR
DP9325252-10G	Flexible power cable (10m) for SGMEV 200V (0.10-0.75Kw)	232 EUR
DP9325252-15G	Flexible power cable (15m) for SGMEV 200V (0.10-0.75Kw)	312 EUR
DP9325252-20G	Flexible power cable (20m) for SGMEV 200V (0.10-0.75Kw)	387 EUR
DP9325254-03G	Flexible power cable (3m) for SGMEV 200V (1.50Kw)	164 EUR
DP9325254-05G	Flexible power cable (5m) for SGMEV 200V (1.50Kw)	204 EUR
DP9325254-10G	Flexible power cable (10m) for SGMEV 200V (1.50Kw)	292 EUR
DP9325254-15G	Flexible power cable (15m) for SGMEV 200V (1.50Kw)	375 EUR
DP9325254-20G	Flexible power cable (20m) for SGMEV 200V (1.50Kw)	464 EUR

## SGMEV Servo Motor Power + Brake Cable Flexible 200V

Ürün Kodu	Açıklama	Liste Fiyatı
DP9325253-03G	Flexible power + Brake cable (3m) for SGMEV 200V (0.10-0.75Kw)	151 EUR
DP9325253-05G	Flexible power + Brake cable (5m) for SGMEV 200V (0.10-0.75Kw)	187 EUR
DP9325253-10G	Flexible power + Brake cable (10m) for SGMEV 200V (0.10-0.75Kw)	274 EUR
DP9325253-15G	Flexible power + Brake cable (15m) for SGMEV 200V (0.10-0.75Kw)	333 EUR
DP9325253-20G	Flexible power + Brake cable (20m) for SGMEV 200V (0.10-0.75Kw)	414 EUR
DP9325255-03G	Flexible power + Brake cable (20m) for SGMEV 200V (1.50kw)	169 EUR
DP9325255-05G	Flexible power + Brake cable (20m) for SGMEV 200V (1.50kw)	207 EUR
DP9325255-10G	Flexible power + Brake cable (20m) for SGMEV 200V (1.50kw)	298 EUR
DP9325255-15G	Flexible power + Brake cable (20m) for SGMEV 200V (1.50kw)	379 EUR
DP9325255-20G	Flexible power + Brake cable (20m) for SGMEV 200V (1.50kw)	456 EUR

## SGMEV Encoder Cable Flexible 200V

Ürün Kodu	Açıklama	Liste Fiyatı
DP9325256-03G	SGMEV Encoder Cable Flexible (3m)	193 EUR
DP9325256-05G	SGMEV Encoder Cable Flexible (5m)	232 EUR
DP9325256-10G	SGMEV Encoder Cable Flexible (10m)	277 EUR
DP9325256-15G	SGMEV Encoder Cable Flexible (15m)	351 EUR
DP9325256-20G	SGMEV Encoder Cable Flexible (20m)	411 EUR

## Special Cable for Absolut Encoder 200V

Ürün Kodu	Açıklama	Liste Fiyatı
JZSP-CSP12-E-G5	Extension Encoder cable with Connectors length 0.3m for Abs. Encoder, incl. Battery	100 EUR

## SGMEV Connectors 200V

Ürün Kodu	Açıklama	Liste Fiyatı
SPOC06KFSDN169	Motor connector kit for SGMEV (0.10-1.50kW)	Sorunuz
SPOC17HFRON169	Encoder connector for SGMEV (0.10-1.50kW)	108 EUR



## High Speed Servomotor Sigma V Series (SGMSV)

- @ 1,0kW - 5,0kW
- @ 400V
- @ 3.000 rpm rated speed, 5.000 / 6.000 rpm max. speed
- @ 3.18-15.8 Nm rated torque
- @ Optional 24VDC holding brake
- @ Special Dust Seal / Oil Seal optional
- @ IP67 (except for shaft opening)
- @ CE certified, cULus-listed and RoHS conform

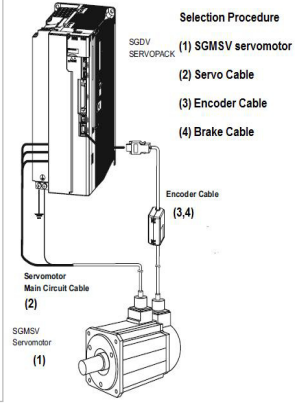

### SGMSV Low Inertia Servo Motor 20-bit Incremental Encoder

Ürün Kodu	Açıklama	Liste Fiyatı
SGMSV-10DDA6F	AC Motor 400V 3ph,1.00kW (3.18Nm rated, 9.45Nm Peak) 20bit IncEnc, DustS	1.161 EUR
SGMSV-15DDA6F	AC Motor 400V 3ph,1.50kW (4.9Nm rated, 14.7Nm peak) 20bit IncEnc, DustS	1.257 EUR
SGMSV-20DDA6F	AC Motor 400V 3ph,2.00kW (6.36Nm rated, 19.1Nm peak) 20bit IncEnc, DustS	1.355 EUR
SGMSV-25DDA6F	AC Motor 400V 3ph,2.50kW (7.96Nm rated, 23.9Nm peak) 20bit IncEnc, DustS	1.405 EUR
SGMSV-30DDA6F	AC Motor 400V 3ph,3.00kW (9.8Nm rated, 29.4Nm peak) 20bit IncEnc, DustS	1.676 EUR
SGMSV-40DDA6F	AC Motor 400V 3ph,4.00kW (12.6Nm rated, 37.8Nm peak) 20bit IncEnc, DustS	1.900 EUR
SGMSV-50DDA6F	AC Motor 400V 3ph 5.00kW (15.8Nm rated, 47.6Nm peak) 20bit IncEnc, DustS	2.593 EUR

### SGMSV Low Inertia Servo Motor 20-bit Incremental Encoder + Brake

Ürün Kodu	Açıklama	Liste Fiyatı
SGMSV-10DDA6H	AC Motor 400V 3ph,1.00kW (3.18Nm rated, 9.45Nm Peak) 20bit IncEnc, DustS + Brake	1.318 EUR
SGMSV-15DDA6H	AC Motor 400V 3ph,1.50kW (4.9Nm rated, 14.7Nm peak) 20bit IncEnc, DustS + Brake	1.467 EUR
SGMSV-20DDA6H	AC Motor 400V 3ph,2.00kW (6.36Nm rated, 19.1Nm peak) 20bit IncEnc, DustS + Brake	1.613 EUR
SGMSV-25DDA6H	AC Motor 400V 3ph,2.50kW (7.96Nm rated, 23.9Nm peak) 20bit IncEnc, DustS + Brake	1.613 EUR
SGMSV-30DDA6H	AC Motor 400V 3ph,3.00kW (9.8Nm rated, 29.4Nm peak) 20bit IncEnc, DustS + Brake	2.426 EUR
SGMSV-40DDA6H	AC Motor 400V 3ph,4.00kW (12.6Nm rated, 37.8Nm peak) 20bit IncEnc, DustS + Brake	2.738 EUR
SGMSV-50DDA6H	AC Motor 400V 3ph 5.00kW (15.8Nm rated, 47.6Nm peak) 20bit IncEnc, DustS + Brake	3.376 EUR

### SGMSV Low Inertia Servo Motor 20-bit Absolut Encoder

Ürün Kodu	Açıklama	Liste Fiyatı
SGMSV-10D3A6F	AC Motor 400V 3ph,1.00kW (3.18Nm rated, 9.45Nm Peak) 20bit AbsEnc, DustS	1.318 EUR
SGMSV-15D3A6F	AC Motor 400V 3ph,1.50kW (4.9Nm rated, 14.7Nm peak) 20bit AbsEnc, DustS	1.418 EUR
SGMSV-20D3A6F	AC Motor 400V 3ph,2.00kW (6.36Nm rated, 19.1Nm peak) 20bit AbsEnc, DustS	1.513 EUR
SGMSV-25D3A6F	AC Motor 400V 3ph,2.50kW (7.96Nm rated, 23.9Nm peak) 20bit AbsEnc, DustS	1.562 EUR
SGMSV-30D3A6F	AC Motor 400V 3ph,3.00kW (9.8Nm rated, 29.4Nm peak) 20bit AbsEnc, DustS	1.862 EUR
SGMSV-40D3A6F	AC Motor 400V 3ph,4.00kW (12.6Nm rated, 37.8Nm peak) 20bit AbsEnc, DustS	2.065 EUR
SGMSV-50D3A6F	AC Motor 400V 3ph 5.00kW (15.8Nm rated, 47.6Nm peak) 20bit AbsEnc, DustS	2.703 EUR



## SGMSV Low Inertia Servo Motor 20-bit Absolut Encoder + Brake

Ürün Kodu	Açıklama	Liste Fiyatı
SGMSV-10D3A6H	AC Motor 400V 3ph,1.00kW (3.18Nm rated, 9.45Nm Peak) 20bit AbsEnc, DustS + Brake	1.467 EUR
SGMSV-15D3A6H	AC Motor 400V 3ph,1.50kW (4.9Nm rated, 14.7Nm peak) 20bit AbsEnc, DustS + Brake	1.613 EUR
SGMSV-20D3A6H	AC Motor 400V 3ph,2.00kW (6.36Nm rated, 19.1Nm peak) 20bit AbsEnc, DustS + Brake	1.757 EUR
SGMSV-25D3A6H	AC Motor 400V 3ph,2.50kW (7.96Nm rated, 23.9Nm peak) 20bit AbsEnc, DustS + Brake	2.002 EUR
SGMSV-30D3A6H	AC Motor 400V 3ph,3.00kW (9.8Nm rated, 29.4Nm peak) 20bit AbsEnc, DustS + Brake	2.593 EUR
SGMSV-40D3A6H	AC Motor 400V 3ph,4.00kW (12.6Nm rated, 37.8Nm peak) 20bit AbsEnc, DustS + Brake	2.903 EUR
SGMSV-50D3A6H	AC Motor 400V 3ph 5.00kW (15.8Nm rated, 47.6Nm peak) 20bit AbsEnc, DustS + Brake	3.548 EUR

Please note that Yaskawa has got also Servo Motors with special Oil Seal or Motors without Keyway in the product portfolio which can be quoted on demand !

## SGMSV Servo Motor Angled Power Cable Flexible

Ürün Kodu	Açıklama	Liste Fiyatı
JZSP-CVMCA11-03-E-G5	Flexible Angled Connector CE05 Power cable(3m) for SGMSV(1.00-1.50kW)	220 EUR
JZSP-CVMCA11-05-E-G5	Flexible Angled Connector CE05 Power cable(5m) for SGMSV(1.00-1.50kW)	258 EUR
JZSP-CVMCA11-10-E-G5	Flexible Angled Connector CE05 Power cable(10m) for SGMSV(1.00-1.50kW)	312 EUR
JZSP-CVMCA11-15-E-G5	Flexible Angled Connector CE05 Power cable(15m) for SGMSV(1.00-1.50kW)	379 EUR
JZSP-CVMCA11-20-E-G5	Flexible Angled Connector CE05 Power cable(20m) for SGMSV(1.00-1.50kW)	443 EUR
JZSP-CVMCA12-03-E-G5	Flexible Angled Connector CE05 Power cable(3m) for SGMSV(2.00-2.50kW)	236 EUR
JZSP-CVMCA12-05-E-G5	Flexible Angled Connector CE05 Power cable(5m) for SGMSV(2.00-2.50kW)	274 EUR
JZSP-CVMCA12-10-E-G5	Flexible Angled Connector CE05 Power cable(10m) for SGMSV(2.00-2.50kW)	361 EUR
JZSP-CVMCA12-15-E-G5	Flexible Angled Connector CE05 Power cable(15m) for SGMSV(2.00-2.50kW)	452 EUR
JZSP-CVMCA12-20-E-G5	Flexible Angled Connector CE05 Power cable(20m) for SGMSV(2.00-2.50kW)	544 EUR
JZSP-CVMCA13-03-E-G5	Flexible Angled Connector CE05 Power cable(3m) for SGMSV(3.00-5.00kW)	290 EUR
JZSP-CVMCA13-05-E-G5	Flexible Angled Connector CE05 Power cable(5m) for SGMSV(3.00-5.00kW)	332 EUR
JZSP-CVMCA13-10-E-G5	Flexible Angled Connector CE05 Power cable(10m) for SGMSV(3.00-5.00kW)	406 EUR
JZSP-CVMCA13-15-E-G5	Flexible Angled Connector CE05 Power cable(15m) for SGMSV(3.00-5.00kW)	481 EUR
JZSP-CVMCA13-20-E-G5	Flexible Angled Connector CE05 Power cable(20m) for SGMSV(3.00-5.00kW)	574 EUR

## SGMSV Incremental Encoder Angled Cable Flexible

Ürün Kodu	Açıklama	Liste Fiyatı
JZSP-CVP12-03-E-G5	Flexible Incremental Encoder Angled Connector Cable(3m) for SGMSV	169 EUR
JZSP-CVP12-05-E-G5	Flexible Incremental Encoder Angled Connector Cable(5m) for SGMSV	191 EUR
JZSP-CVP12-10-E-G5	Flexible Incremental Encoder Angled Connector Cable(10m) for SGMSV	232 EUR
JZSP-CVP12-15-E-G5	Flexible Incremental Encoder Angled Connector Cable(15m) for SGMSV	278 EUR
JZSP-CVP12-20-E-G5	Flexible Incremental Encoder Angled Connector Cable(20m) for SGMSV	329 EUR
JZSP-CVP12-25-E-G5	Flexible Incremental Encoder Angled Connector Cable(25m) for SGMSV	385 EUR
JZSP-CVP12-30-E-G5	Flexible Incremental Encoder Angled Connector Cable(30m) for SGMSV	425 EUR
JZSP-CVP12-35-E-G5	Flexible Incremental Encoder Angled Connector Cable(35m) for SGMSV	469 EUR

## SGMSV Absolute Encoder Angled Cable Flexible

Ürün Kodu	Açıklama	Liste Fiyatı
JZSP-CVP27-03-E-G5	Flexible Absolute Encoder Angled Connector Cable(3m) for SGMSV	288 EUR
JZSP-CVP27-05-E-G5	Flexible Absolute Encoder Angled Connector Cable(5m) for SGMSV	312 EUR
JZSP-CVP27-10-E-G5	Flexible Absolute Encoder Angled Connector Cable(10m) for SGMSV	371 EUR
JZSP-CVP27-15-E-G5	Flexible Absolute Encoder Angled Connector Cable(15m) for SGMSV	432 EUR
JZSP-CVP27-20-E-G5	Flexible Absolute Encoder Angled Connector Cable(20m) for SGMSV	492 EUR

## Special Cable for Absolut Encoder

Ürün Kodu	Açıklama	Liste Fiyatı
JZSP-CSP12-E-G5	Extension Encoder cable with Connectors length 0.3m for Abs. Encoder, incl. Battery	100 EUR

## SGMSV Brake Cable Flexible

Ürün Kodu	Açıklama	Liste Fiyatı
JZSP-CVB12Y-03-E-G5	Flexible Angled Connector Brake cable(3m) for SGMSV	155 EUR
JZSP-CVB12Y-05-E-G5	Flexible Angled Connector Brake cable(5m) for SGMSV	175 EUR
JZSP-CVB12Y-10-E-G5	Flexible Angled Connector Brake cable(10m) for SGMSV	232 EUR
JZSP-CVB12Y-15-E-G5	Flexible Angled Connector Brake cable(15m) for SGMSV	288 EUR
JZSP-CVB12Y-20-E-G5	Flexible Angled Connector Brake cable(20m) for SGMSV	339 EUR
JZSP-CVB12Y-30-E-G5	Flexible Angled Connector Brake cable(30m) for SGMSV	449 EUR
JZSP-CVB12Y-35-E-G5	Flexible Angled Connector Brake cable(35m) for SGMSV	507 EUR

## SGMSV Connectors

Ürün Kodu	Açıklama	Liste Fiyatı
CM10-AP10S-M-D-G1	Encoder Connector Kit, L-shaped Plug	54 EUR
CM10-SP-10S-M-D-G*	Encoder Connector Kit, straight Plug	60 EUR
CM10Y-AP2S-M-D-G1	Brake connector (m) for SGMSV (1.00-5.00kW), L-shaped Plug	112 EUR
CM10Y-SP2S-M-D-G*	Brake connector (m) for SGMSV (1.00-5.00kW), straight Plug	Sorunuz
JZSP-CMP9-1-E-G1	Connector Kit Encoder for amplifier side CN2	20 EUR
JZSP-CVM18-10-E-G4	Motor Connector Kit for SGMSV (1.00-2.50kW)	46 EUR
JZSP-CVM22-22-E-G4	Motor Connector Kit for SGMSV (3.00-5.00kW)	91 EUR



## High Speed Servomotor Sigma V Series (SGMGV)

- @ 0,3kW - 15kW
- @ 400V
- @ 1.500 rpm rated speed, 3.000 / 2.000 rpm max. speed
- @ 1.96-95.4 Nm rated torque
- @ Optional 24VDC holding brake
- @ Special Dust Seal and Oil Seal optional
- @ IP67 (except for shaft opening)
- @ CE certified, cULus-listed and RoHS conform

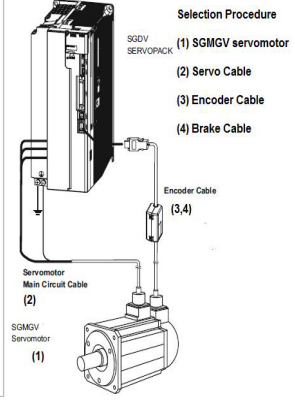

### SGMGV Servo Motor 20-bit Incremental Encoder

Ürün Kodu	Açıklama	Liste Fiyatı
SGMGV-03DDA6F	AC Motor 400V 3ph,0.30kW (1.96Nm rated, 5.88Nm peak) 20bit IncEnc, DustS	636 EUR
SGMGV-05DDA6F	AC Motor 400V 3ph,0.45kW (2.86Nm rated, 8.92Nm peak) 20bit IncEnc, DustS	727 EUR
SGMGV-09DDA6F	AC Motor 400V 3ph,0.85kW (5.39Nm rated, 13.8Nm peak) 20bit IncEnc, DustS	735 EUR
SGMGV-13DDA6F	AC Motor 400V 3ph,1.30kW (8.34Nm rated, 23.3Nm peak) 20bit IncEnc, DustS	813 EUR
SGMGV-20DDA6F	AC Motor 400V 3ph,1.80kW (11.5Nm rated, 28.7Nm peak) 20bit IncEnc, DustS	1.043 EUR
SGMGV-30DDA6F	AC Motor 400V 3ph,2.90kW (18.6Nm rated, 45.1Nm peak) 20bit IncEnc, DustS	1.490 EUR
SGMGV-44DDA6F	AC Motor 400V 3ph,4.40kW (28.4Nm rated, 71.1Nm peak) 20bit IncEnc, DustS	1.802 EUR
SGMGV-55DDA6F	AC Motor 400V 3ph,5.50kW (35.0Nm rated, 87.6Nm peak) 20bit IncEnc, DustS	2.447 EUR
SGMGV-75DDA6F	AC Motor 400V 3ph,7.50kW (48.0Nm rated, 119Nm peak) 20bit IncEnc, DustS	2.964 EUR
SGMGV-1ADDA6F	AC Motor 400V 3ph,11kW (70.0Nm rated, 175Nm peak) 20bit IncEnc, DustS	4.050 EUR
SGMGV-1EDDA6F	AC Motor 400V 3ph,15kW (95.4Nm rated, 224Nm peak) 20bit IncEnc, DustS	5.854 EUR

### SGMGV Servo Motor 20-bit Incremental Encoder + Brake

Ürün Kodu	Açıklama	Liste Fiyatı
SGMGV-03DDA6H	AC Motor 400V 3ph,0.30kW (1.96Nm rated, 5.88Nm peak) 20bit IncEnc, DustS + Brake	1.061 EUR
SGMGV-05DDA6H	AC Motor 400V 3ph,0.45kW (2.86Nm rated, 8.92Nm peak) 20bit IncEnc, DustS + Brake	927 EUR
SGMGV-09DDA6H	AC Motor 400V 3ph,0.85kW (5.39Nm rated, 13.8Nm peak) 20bit IncEnc, DustS + Brake	1.035 EUR
SGMGV-13DDA6H	AC Motor 400V 3ph,1.30kW (8.34Nm rated, 23.3Nm peak) 20bit IncEnc, DustS + Brake	1.118 EUR
SGMGV-20DDA6H	AC Motor 400V 3ph,1.80kW (11.5Nm rated, 28.7Nm peak) 20bit IncEnc, DustS + Brake	1.623 EUR
SGMGV-30DDA6H	AC Motor 400V 3ph,2.90kW (18.6Nm rated, 45.1Nm peak) 20bit IncEnc, DustS + Brake	2.288 EUR
SGMGV-44DDA6H	AC Motor 400V 3ph,4.40kW (28.4Nm rated, 71.1Nm peak) 20bit IncEnc, DustS + Brake	2.416 EUR
SGMGV-55DDA6H	AC Motor 400V 3ph,5.50kW (35.0Nm rated, 87.6Nm peak) 20bit IncEnc, DustS + Brake	3.455 EUR
SGMGV-75DDA6H	AC Motor 400V 3ph,7.50kW (48.0Nm rated, 119Nm peak) 20bit IncEnc, DustS + Brake	3.890 EUR
SGMGV-1ADDA6H	AC Motor 400V 3ph,11kW (70.0Nm rated, 175Nm peak) 20bit IncEnc, DustS + Brake	5.782 EUR
SGMGV-1EDDA6H	AC Motor 400V 3ph,15kW (95.4Nm rated, 224Nm peak) 20bit IncEnc, DustS + Brake	7.996 EUR

### SGMGV Servo Motor 20-bit Absolute Encoder

Ürün Kodu	Açıklama	Liste Fiyatı
SGMGV-03D3A6F	AC Motor 400V 3ph,0.30kW (1.96Nm rated, 5.88Nm peak) 20bit AbsEnc, DustS	883 EUR
SGMGV-05D3A6F	AC Motor 400V 3ph,0.45kW (2.86Nm rated, 8.92Nm peak) 20bit AbsEnc, DustS	913 EUR
SGMGV-09D3A6F	AC Motor 400V 3ph,0.85kW (5.39Nm rated, 13.8Nm peak) 20bit AbsEnc, DustS	1.008 EUR
SGMGV-13D3A6F	AC Motor 400V 3ph,1.30kW (8.34Nm rated, 23.3Nm peak) 20bit AbsEnc, DustS	1.104 EUR
SGMGV-20D3A6F	AC Motor 400V 3ph,1.80kW (11.5Nm rated, 28.7Nm peak) 20bit AbsEnc, DustS	1.393 EUR
SGMGV-30D3A6F	AC Motor 400V 3ph,2.90kW (18.6Nm rated, 45.1Nm peak) 20bit AbsEnc, DustS	1.709 EUR
SGMGV-44D3A6F	AC Motor 400V 3ph,4.40kW (28.4Nm rated, 71.1Nm peak) 20bit AbsEnc, DustS	2.018 EUR
SGMGV-55D3A6F	AC Motor 400V 3ph,5.50kW (35.0Nm rated, 87.6Nm peak) 20bit AbsEnc, DustS	2.580 EUR
SGMGV-75D3A6F	AC Motor 400V 3ph,7.50kW (48.0Nm rated, 119Nm peak) 20bit AbsEnc, DustS	3.099 EUR
SGMGV-1AD3A6F	AC Motor 400V 3ph,11kW (70.0Nm rated, 175Nm peak) 20bit AbsEnc, DustS	4.195 EUR
SGMGV-1ED3A6F	AC Motor 400V 3ph,15kW (95.4Nm rated, 224Nm peak) 20bit AbsEnc, DustS	5.998 EUR

## SGMGV Servo Motor 20-bit Absolute Encoder + Brake

Ürün Kodu	Açıklama	Liste Fiyatı
SGMGV-03D3A6H	AC Motor 400V 3ph,0.30kW (1.96Nm rated, 5.88Nm peak) 20bit AbsEnc, DustS + Brake	1.192 EUR
SGMGV-05D3A6H	AC Motor 400V 3ph,0.45kW (2.86Nm rated, 8.92Nm peak) 20bit AbsEnc, DustS + Brake	1.221 EUR
SGMGV-09D3A6H	AC Motor 400V 3ph,0.85kW (5.39Nm rated, 13.8Nm peak) 20bit AbsEnc, DustS + Brake	1.359 EUR
SGMGV-13D3A6H	AC Motor 400V 3ph,1.30kW (8.34Nm rated, 23.3Nm peak) 20bit AbsEnc, DustS + Brake	1.461 EUR
SGMGV-20D3A6H	AC Motor 400V 3ph,1.80kW (11.5Nm rated, 28.7Nm peak) 20bit AbsEnc, DustS + Brake	1.788 EUR
SGMGV-30D3A6H	AC Motor 400V 3ph,2.90kW (18.6Nm rated, 45.1Nm peak) 20bit AbsEnc, DustS + Brake	2.870 EUR
SGMGV-44D3A6H	AC Motor 400V 3ph,4.40kW (28.4Nm rated, 71.1Nm peak) 20bit AbsEnc, DustS + Brake	3.008 EUR
SGMGV-55D3A6H	AC Motor 400V 3ph 5.50kW (35Nm rated, 87,6Nm peak) 20bit AbsEnc, DustS + Brake	3.589 EUR
SGMGV-75D3A6H	AC Motor 400V 3ph 7.50kW (48Nm rated, 119Nm peak) 20bit AbsEnc, DustS + Brake	4.470 EUR
SGMGV-1AD3A6H	AC Motor 400V 3ph 11kW (70Nm rated, 175Nm peak) 20bit AbsEnc, DustS + Brake	6.389 EUR
SGMGV-1ED3A6H	AC Motor 400V 3ph 15kW (95,4Nm rated, 224Nm peak) 20bit AbsEnc, DustS + Brake	9.823 EUR

Please note that Yaskawa has got also Servo Motors with special Oil Seal or Motors without Keyway in the product portfolio which can be quoted on demand !

## SGMGV Servo Motor Angled Power Cable Flexible

Ürün Kodu	Açıklama	Liste Fiyatı
JZSP-CVM21-03-E-G5	Flexible Angled Connector CE05 Power cable(3m) for SGMGV(0.30-0.45Kw)	132 EUR
JZSP-CVM21-05-E-G5	Flexible Angled Connector CE05 Power cable(5m) for SGMGV(0.30-0.45Kw)	166 EUR
JZSP-CVM21-10-E-G5	Flexible Angled Connector CE05 Power cable(10m) for SGMGV(0.30-0.45Kw)	240 EUR
JZSP-CVM21-15-E-G5	Flexible Angled Connector CE05 Power cable(15m) for SGMGV(0.30-0.45Kw)	314 EUR
JZSP-CVM21-20-E-G5	Flexible Angled Connector CE05 Power cable(20m) for SGMGV(0.30-0.45Kw)	384 EUR
JZSP-CVM21-30-E-G5	Flexible Angled Connector CE05 Power cable(30m) for SGMGV(0.30-0.45Kw)	681 EUR
JZSP-CVM21-40-E-G5	Flexible Angled Connector CE05 Power cable(40m) for SGMGV(0.30-0.45Kw)	905 EUR
JZSP-CVM21-50-E-G5	Flexible Angled Connector CE05 Power cable(50m) for SGMGV(0.30-0.45Kw)	1.112 EUR
JZSP-CVM41-03-E-G5	Flexible Angle CE05 Power + Brake cable(3m) for SGMGV(0.30-0.45Kw)	153 EUR
JZSP-CVM41-05-E-G5	Flexible Angle CE05 Power + Brake cable(5m) for SGMGV(0.30-0.45Kw)	171 EUR
JZSP-CVM41-10-E-G5	Flexible Angle CE05 Power + Brake cable(10m) for SGMGV(0.30-0.45Kw)	197 EUR
JZSP-CVM41-20-E-G5	Flexible Angle CE05 Power + Brake cable(20m) for SGMGV(0.30-0.45Kw)	272 EUR
JZSP-CVMCA11-03-E-G5	Flexible Angled Connector CE05 Power cable(3m) for SGMGV(0.85Kw)	220 EUR
JZSP-CVMCA11-05-E-G5	Flexible Angled Connector CE05 Power cable(5m) for SGMGV(0.85Kw)	258 EUR
JZSP-CVMCA11-10-E-G5	Flexible Angled Connector CE05 Power cable(10m) for SGMGV(0.85Kw)	312 EUR
JZSP-CVMCA11-15-E-G5	Flexible Angled Connector CE05 Power cable(15m) for SGMGV(0.85Kw)	379 EUR
JZSP-CVMCA11-20-E-G5	Flexible Angled Connector CE05 Power cable(20m) for SGMGV(0.85Kw)	443 EUR
JZSP-CVMCA12-03-E-G5	Flexible Angled Connector CE05 Power cable(3m) for SGMGV(1.30-1.80Kw)	236 EUR
JZSP-CVMCA12-05-E-G5	Flexible Angled Connector CE05 Power cable(5m) for SGMGV(1.30-1.80Kw)	274 EUR
JZSP-CVMCA12-10-E-G5	Flexible Angled Connector CE05 Power cable(10m) for SGMGV(1.30-1.80Kw)	361 EUR
JZSP-CVMCA12-15-E-G5	Flexible Angled Connector CE05 Power cable(15m) for SGMGV(1.30-1.80Kw)	452 EUR
JZSP-CVMCA12-20-E-G5	Flexible Angled Connector CE05 Power cable(20m) for SGMGV(1.30-1.80Kw)	544 EUR
JZSP-CVMCA13-03-E-G5	Flexible Angled Connector CE05 Power cable(3m) for SGMGV(2.90-4.40Kw)	290 EUR
JZSP-CVMCA13-05-E-G5	Flexible Angled Connector CE05 Power cable(5m) for SGMGV(2.90-4.40Kw)	332 EUR
JZSP-CVMCA13-10-E-G5	Flexible Angled Connector CE05 Power cable(10m) for SGMGV(2.90-4.40Kw)	406 EUR
JZSP-CVMCA13-15-E-G5	Flexible Angled Connector CE05 Power cable(15m) for SGMGV(2.90-4.40Kw)	481 EUR
JZSP-CVMCA13-20-E-G5	Flexible Angled Connector CE05 Power cable(20m) for SGMGV(2.90-4.40Kw)	574 EUR
JZSP-CVMCA14-03-E-G5	Flexible Angled Connector CE05 Power cable(3m) for SGMGV(5.50Kw)	483 EUR
JZSP-CVMCA14-05-E-G5	Flexible Angled Connector CE05 Power cable(5m) for SGMGV(5.50Kw)	540 EUR
JZSP-CVMCA14-10-E-G5	Flexible Angled Connector CE05 Power cable(10m) for SGMGV(5.50Kw)	682 EUR
JZSP-CVMCA14-15-E-G5	Flexible Angled Connector CE05 Power cable(15m) for SGMGV(5.50Kw)	823 EUR
JZSP-CVMCA14-20-E-G5	Flexible Angled Connector CE05 Power cable(20m) for SGMGV(5.50Kw)	965 EUR
JZSP-CVMCA15-03-E-G5	Flexible Angled Connector CE05 Power cable(3m) for SGMGV(7.50-11Kw)	512 EUR
JZSP-CVMCA15-05-E-G5	Flexible Angled Connector CE05 Power cable(5m) for SGMGV(7.50-11Kw)	589 EUR
JZSP-CVMCA15-10-E-G5	Flexible Angled Connector CE05 Power cable(10m) for SGMGV(7.50-11Kw)	741 EUR
JZSP-CVMCA15-15-E-G5	Flexible Angled Connector CE05 Power cable(15m) for SGMGV(7.50-11Kw)	881 EUR
JZSP-CVMCA15-20-E-G5	Flexible Angled Connector CE05 Power cable(20m) for SGMGV(7.50-11Kw)	1.050 EUR
JZSP-CVMCA16-03-E-G5	Flexible Angled Connector CE05 Power cable(3m) for SGMGV(15Kw)	610 EUR
JZSP-CVMCA16-05-E-G5	Flexible Angled Connector CE05 Power cable(5m) for SGMGV(15Kw)	728 EUR
JZSP-CVMCA16-10-E-G5	Flexible Angled Connector CE05 Power cable(10m) for SGMGV(15Kw)	1.309 EUR
JZSP-CVMCA16-15-E-G5	Flexible Angled Connector CE05 Power cable(15m) for SGMGV(15Kw)	1.684 EUR
JZSP-CVMCA16-20-E-G5	Flexible Angled Connector CE05 Power cable(20m) for SGMGV(15Kw)	1.804 EUR

## SGMGV Incremental Encoder Angled Cable Flexible

Ürün Kodu	Açıklama	Liste Fiyatı
JZSP-CVP12-03-E-G5	Flexible Incremental Encoder Angled Connector Cable(3m) for SGMGV	169 EUR
JZSP-CVP12-05-E-G5	Flexible Incremental Encoder Angled Connector Cable(5m) for SGMGV	191 EUR
JZSP-CVP12-10-E-G5	Flexible Incremental Encoder Angled Connector Cable(10m) for SGMGV	232 EUR
JZSP-CVP12-15-E-G5	Flexible Incremental Encoder Angled Connector Cable(15m) for SGMGV	278 EUR
JZSP-CVP12-20-E-G5	Flexible Incremental Encoder Angled Connector Cable(20m) for SGMGV	329 EUR
JZSP-CVP12-25-E-G5	Flexible Incremental Encoder Angled Connector Cable(25m) for SGMGV	385 EUR
JZSP-CVP12-30-E-G5	Flexible Incremental Encoder Angled Connector Cable(30m) for SGMGV	425 EUR
JZSP-CVP12-35-E-G5	Flexible Incremental Encoder Angled Connector Cable(35m) for SGMGV	469 EUR

## Special Cable for Absolut Encoder

Ürün Kodu	Açıklama	Liste Fiyatı
JZSP-CSP12-E-G5	Extension Encoder cable with Connectors length 0.3m for Abs. Encoder, incl. Battery	100 EUR

## SGMGV Absolute Encoder Angled Cable Flexible

Ürün Kodu	Açıklama	Liste Fiyatı
JZSP-CVP27-03-E-G5	Flexible Absolute Encoder Angled Connector Cable(3m) for SGMGV	288 EUR
JZSP-CVP27-05-E-G5	Flexible Absolute Encoder Angled Connector Cable(5m) for SGMGV	312 EUR
JZSP-CVP27-10-E-G5	Flexible Absolute Encoder Angled Connector Cable(10m) for SGMGV	371 EUR
JZSP-CVP27-15-E-G5	Flexible Absolute Encoder Angled Connector Cable(15m) for SGMGV	432 EUR
JZSP-CVP27-20-E-G5	Flexible Absolute Encoder Angled Connector Cable(20m) for SGMGV	492 EUR

## SGMGV Brake Cable Flexible

Ürün Kodu	Açıklama	Liste Fiyatı
JZSP-CVB12Y-03-E-G5	Flexible Angled Connector Brake cable(3m) for SGMGV	155 EUR
JZSP-CVB12Y-05-E-G5	Flexible Angled Connector Brake cable(5m) for SGMGV	175 EUR
JZSP-CVB12Y-10-E-G5	Flexible Angled Connector Brake cable(10m) for SGMGV	232 EUR
JZSP-CVB12Y-15-E-G5	Flexible Angled Connector Brake cable(15m) for SGMGV	288 EUR
JZSP-CVB12Y-20-E-G5	Flexible Angled Connector Brake cable(20m) for SGMGV	339 EUR
JZSP-CVB12Y-30-E-G5	Flexible Angled Connector Brake cable(30m) for SGMGV	449 EUR
JZSP-CVB12Y-35-E-G5	Flexible Angled Connector Brake cable(35m) for SGMGV	507 EUR

## SGMGV Connectors

Ürün Kodu	Açıklama	Liste Fiyatı
CM10-AP10S-M-D-G1	Encoder Connector Kit L-shaped Plug	54 EUR
CM10-SP-10S-M-D-G*	Encoder Connector Kit Straight Plug	60 EUR
CM10Y-SP2S-M-D-G*	Brake connector (m) for SGMGV (1.00-5.00kW), straight Plug	Sorunuz
JZSP-CMP9-1-E-G1	Connector Kit Encoder CN2	20 EUR
JZSP-CVM9-1-E	Motor End Connector Kit for SGMGV (0.30-0.45kW)	42 EUR
CM10Y-AP2S-M-D-G1	Holding Brake Connector Kit for SGMGV (0.85kW-15kW)	112 EUR
JZSP-CVM18-10-E-G4	Motor Connector Kit for SGMGV (0.85-1.80kW)	46 EUR
JZSP-CVM22-22-E-G4	Motor Connector Kit for SGMGV (2.90-4.40kW)	91 EUR
JZSP-CVM32-17-E-G4	Motor Connector Kit for SGMGV (5.50-15.0kW)	119 EUR

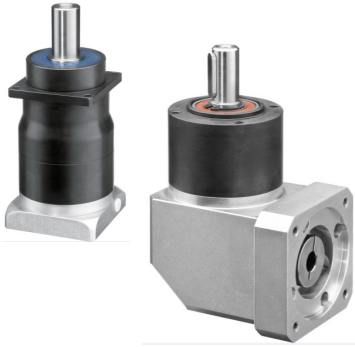

## Planetary Gears ECO and PURE

- @ Standard Flange Planetary Gear boxes --> ECO series
- @ Standard Flange Low Backlash Planetary Gear boxes --> Pure series
- @ For Sigma 5 & Sigma 7 Servo Motors
- @ Efficiency: ECO: 96%, PURE 97%
- @ Backlash: ECO: <math>10' / 15'</math>, PURE: <math>2' / 4'</math>
- @ Lifetime lubrication with synthetic grease
- @ Any mounting position

### Model Designation

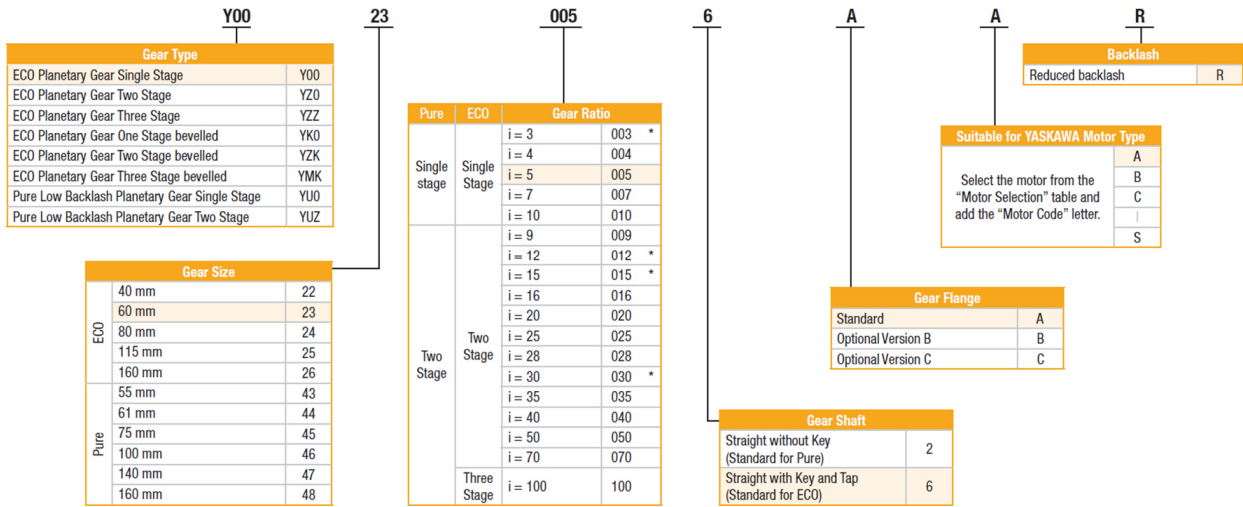

\* Not available for Y0022 and YZ022.

### Standard Flange Planetary Gear boxes ECO series

Ürün Kodu	Açıklama	Liste Fiyatı
Y0022xxx6A-x	Gear size 22, single stage, standard flange, straight shaft with Key and tab	430 EUR
YZ022xxx6A-x	Gear size 22, two-stage, standard flange, straight shaft with Key and tab	550 EUR
Y0023xxx6A-x	Gear size 23, single stage, standard flange, straight shaft with Key and tab	418 EUR
YZ023xxx6A-x	Gear size 23, two-stage, standard flange, straight shaft with Key and tab	531 EUR
YZZ23xxx6A-x	Gear size 23, three-stage, standard flange, straight shaft with Key and tab	676 EUR
Y0024xxx6A-x	Gear size 24, single stage, standard flange, straight shaft with Key and tab	591 EUR
YZ024xxx6A-x	Gear size 24, two-stage, standard flange, straight shaft with Key and tab	749 EUR
YZZ24xxx6A-x	Gear size 24, three-stage, standard flange, straight shaft with Key and tab	952 EUR
Y0025xxx6A-x	Gear size 25, single stage, standard flange, straight shaft with Key and tab	993 EUR
YZ025xxx6A-x	Gear size 25, two-stage, standard flange, straight shaft with Key and tab	1.252 EUR
YZZ25xxx6A-x	Gear size 25, three-stage, standard flange, straight shaft with Key and tab	1.577 EUR
Y0026xxx6A-x	Gear size 26, single stage, standard flange, straight shaft with Key and tab	1.490 EUR
YZ026xxx6A-x	Gear size 26, two-stage, standard flange, straight shaft with Key and tab	1.866 EUR
YZZ26xxx6A-x	Gear size 26, three-stage, standard flange, straight shaft with Key and tab	2.290 EUR

## Standard Flange Low Backlash Planetary Gear boxes PURE series

Ürün Kodu	Açıklama	Liste Fiyatı
YU043xxx2A-x	Gear size 43, single stage, standard flange, straight shaft w/o Key and tab	911 EUR
YUZ43xxx2A-x	Gear size 43, two-stage, standard flange, straight shaft w/o Key and tab	1.467 EUR
YU044xxx2A-x	Gear size 44, single stage, standard flange, straight shaft w/o Key and tab	1.161 EUR
YUZ44xxx2A-x	Gear size 44, two-stage, standard flange, straight shaft w/o Key and tab	1.847 EUR
YU045xxx2A-x	Gear size 45, single stage, standard flange, straight shaft w/o Key and tab	1.221 EUR
YUZ45xxx2A-x	Gear size 45, two-stage, standard flange, straight shaft w/o Key and tab	1.983 EUR
YU046xxx2A-x	Gear size 46, single stage, standard flange, straight shaft w/o Key and tab	1.572 EUR
YUZ46xxx2A-x	Gear size 46, two-stage, standard flange, straight shaft w/o Key and tab	2.341 EUR
YU047xxx2A-x	Gear size 47, single stage, standard flange, straight shaft w/o Key and tab	2.479 EUR
YUZ47xxx2A-x	Gear size 47, two-stage, standard flange, straight shaft w/o Key and tab	3.349 EUR
YU048xxx2A-x	Gear size 48, single stage, standard flange, straight shaft w/o Key and tab	3.786 EUR
YUZ48xxx2A-x	Gear size 48, two-stage, standard flange, straight shaft w/o Key and tab	5.095 EUR

## B Flange Planetary Gear boxes ECO series

Ürün Kodu	Açıklama	Liste Fiyatı
Y0022xxx6B-x	Gear size 22, single stage, B flange, straight shaft with Key and tab	430 EUR
YZ022xxx6B-x	Gear size 22, two-stage, B flange, straight shaft with Key and tab	550 EUR
Y0023xxx6B-x	Gear size 23, single stage, B flange, straight shaft with Key and tab	418 EUR
YZ023xxx6B-x	Gear size 23, two-stage, B flange, straight shaft with Key and tab	531 EUR
YZZ23xxx6B-x	Gear size 23, three-stage, B flange, straight shaft with Key and tab	676 EUR
Y0024xxx6B-x	Gear size 24, single stage, B flange, straight shaft with Key and tab	591 EUR
YZ024xxx6B-x	Gear size 24, two-stage, B flange, straight shaft with Key and tab	749 EUR
YZZ24xxx6B-x	Gear size 24, three-stage, B flange, straight shaft with Key and tab	952 EUR
Y0025xxx6B-x	Gear size 25, single stage, B flange, straight shaft with Key and tab	993 EUR
YZ025xxx6B-x	Gear size 25, two-stage, B flange, straight shaft with Key and tab	1.252 EUR
YZZ25xxx6B-x	Gear size 25, three-stage, B flange, straight shaft with Key and tab	1.577 EUR

## C Flange Planetary Gear boxes ECO series

Ürün Kodu	Açıklama	Liste Fiyatı
Y0023xxx6C-x	Gear size 23, single stage, C flange, straight shaft with Key and tab	418 EUR
YZ023xxx6C-x	Gear size 23, two-stage, C flange, straight shaft with Key and tab	531 EUR
YZZ23xxx6C-x	Gear size 23, three-stage, C flange, straight shaft with Key and tab	676 EUR
Y0024xxx6C-x	Gear size 24, single stage, C flange, straight shaft with Key and tab	591 EUR
YZ024xxx6C-x	Gear size 24, two-stage, C flange, straight shaft with Key and tab	749 EUR
YZZ24xxx6C-x	Gear size 24, three-stage, C flange, straight shaft with Key and tab	952 EUR

## Standard Flange Angled Planetary Gear boxes ECO series

Ürün Kodu	Açıklama	Liste Fiyatı
YK023xxx6A-x	Gear size 23, single stage, Standard flange, straight shaft with Key and tab	902 EUR
YZK23xxx6A-x	Gear size 23, two-stage, Standard flange, straight shaft with Key and tab	1.012 EUR
YMK23xxx6A-x	Gear size 23, three-stage, Standard flange, straight shaft with Key and tab	1.157 EUR
YK024xxx6A-x	Gear size 24, single stage, Standard flange, straight shaft with Key and tab	1.271 EUR
YZK24xxx6A-x	Gear size 24, two-stage, Standard flange, straight shaft with Key and tab	1.427 EUR
YMK24xxx6A-x	Gear size 24, three-stage, Standard flange, straight shaft with Key and tab	1.628 EUR

## B Flange Angled Planetary Gear boxes ECO series

Ürün Kodu	Açıklama	Liste Fiyatı
YK023xxx6B-x	Gear size 23, single stage, B flange, straight shaft with Key and tab	933 EUR
YZK23xxx6B-x	Gear size 23, two-stage, B flange, straight shaft with Key and tab	1.052 EUR
YMK23xxx6A-x	Gear size 23, three-stage, B flange, straight shaft with Key and tab	1.157 EUR
YK024xxx6B-x	Gear size 24, single stage, B flange, straight shaft with Key and tab	1.329 EUR
YZK24xxx6B-x	Gear size 24, two-stage, B flange, straight shaft with Key and tab	1.503 EUR
YMK24xxx6B-x	Gear size 24, three-stage, B flange, straight shaft with Key and tab	1.723 EUR

## C Flange Angled Planetary Gear boxes ECO series

Ürün Kodu	Açıklama	Liste Fiyatı
YK023xxx6C-x	Gear size 23, single stage, C flange, straight shaft with Key and tab	948 EUR
YZK23xxx6C-x	Gear size 23, two-stage, C flange, straight shaft with Key and tab	1.076 EUR
YMK23xxx6C-x	Gear size 23, three-stage, C flange, straight shaft with Key and tab	1.236 EUR
YK024xxx6C-x	Gear size 24, single stage, C flange, straight shaft with Key and tab	1.360 EUR
YZK24xxx6C-x	Gear size 24, two-stage, C flange, straight shaft with Key and tab	1.540 EUR
YMK24xxx6C-x	Gear size 24, three-stage, C flange, straight shaft with Key and tab	1.771 EUR

Extra Surcharge NET Key & Tab for: Low Backlash Planetary Gear boxes Pure series	YU043 YUZ43	YU044 YUZ44	YU045 YUZ45	YU046 YUZ46	YU047 YUZ47	YU048 YUZ48
1 - 4 pcs	23,00 €	26,00 €	27,00 €	28,00 €	31,00 €	41,00 €
5 - 10 pcs	14,00 €	16,00 €	17,00 €	19,00 €	22,00 €	27,00 €
11 - 25 pcs	9,00 €	11,00 €	12,00 €	13,00 €	14,00 €	18,00 €
26 - 50 pcs	8,00 €	9,00 €	10,00 €	11,00 €	12,00 €	14,00 €
51-100 pcs	7,00 €	8,00 €	9,00 €	10,00 €	11,00 €	12,00 €
above 100 pcs	6,00 €	7,00 €	8,00 €	9,00 €	10,00 €	11,00 €

Extra Surcharge NET "Reduced Backlash" for: Low Backlash Planetary Gear boxes Pure series	
one stage gear	23,00 €
two-stage gear	30,00 €





## Large-Capacity Servomotor Sigma V Series (SGMVV)

- @ 22kW - 55kW
- @ 400V
- @ 20 bit serial Encoder resolution, Absolutencoder and Incrementalencoder
- @ Rated speed: 800 - 1.500 rpm
- @ Foot-mounted versions and Flange-mounted versions available
- @ CE certified, cULus-listed and RoHS conform

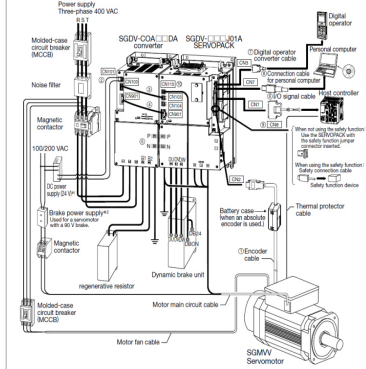

### SGMVV Large Capacity Servo Motor 400V, 1.500 rpm - Flange-mounted Type

Ürün Kodu	Açıklama	Liste Fiyatı
SGMVV-2BD3B6N	AC Motor 400V 3ph,22kW (140Nm rated, 350Nm peak) 1.500 rpm, 20bit AbsEnc, Flange-mount	11.412 EUR
SGMVV-3ZD3B6N	AC Motor 400V 3ph,30kW (191Nm rated, 478Nm peak) 1.500 rpm, 20bit AbsEnc, Flange-mount	12.289 EUR
SGMVV-3GD3B6N	AC Motor 400V 3ph,37kW (236Nm rated, 589Nm peak) 1.500 rpm, 20bit AbsEnc, Flange-mount	12.351 EUR
SGMVV-4ED3B6N	AC Motor 400V 3ph,45kW (286Nm rated, 715Nm peak) 1.500 rpm, 20bit AbsEnc, Flange-mount	14.562 EUR
SGMVV-5ED3B6N	AC Motor 400V 3ph,55kW (350Nm rated, 875Nm peak) 1.500 rpm, 20bit AbsEnc, Flange-mount	18.212 EUR
SGMVV-2BDDB6N	AC Motor 400V 3ph,22kW (140Nm rated, 350Nm peak) 1.500 rpm, 20bit IncEnc, Flange-mount	10.972 EUR
SGMVV-3ZDDB6N	AC Motor 400V 3ph,30kW (191Nm rated, 478Nm peak) 1.500 rpm, 20bit IncEnc, Flange-mount	13.564 EUR
SGMVV-3GDDB6N	AC Motor 400V 3ph,37kW (236Nm rated, 589Nm peak) 1.500 rpm, 20bit IncEnc, Flange-mount	Sorunuz
SGMVV-4EDDB6N	AC Motor 400V 3ph,45kW (286Nm rated, 715Nm peak) 1.500 rpm, 20bit IncEnc, Flange-mount	Sorunuz
SGMVV-5EDDB6N	AC Motor 400V 3ph,55kW (350Nm rated, 875Nm peak) 1.500 rpm, 20bit IncEnc, Flange-mount	19.042 EUR

### SGMVV Large Capacity Servo Motor 400V, 800 rpm - Flange-mounted Type

Ürün Kodu	Açıklama	Liste Fiyatı
SGMVV-2BD3D6N	AC Motor 400V 3ph,22kW (140Nm rated, 350Nm peak) 800 rpm, 20bit AbsEnc, Flange-mount	Sorunuz
SGMVV-3ZD3D6N	AC Motor 400V 3ph,30kW (191Nm rated, 478Nm peak) 800 rpm, 20bit AbsEnc, Flange-mount	Sorunuz
SGMVV-3GD3D6N	AC Motor 400V 3ph,37kW (236Nm rated, 589Nm peak) 800 rpm, 20bit AbsEnc, Flange-mount	Sorunuz
SGMVV-4ED3D6N	AC Motor 400V 3ph,45kW (286Nm rated, 715Nm peak) 800 rpm, 20bit AbsEnc, Flange-mount	19.273 EUR
SGMVV-2BDDB6N	AC Motor 400V 3ph,22kW (140Nm rated, 350Nm peak) 800 rpm, 20bit IncEnc, Flange-mount	Sorunuz
SGMVV-3ZDDB6N	AC Motor 400V 3ph,30kW (191Nm rated, 478Nm peak) 800 rpm, 20bit IncEnc, Flange-mount	Sorunuz
SGMVV-3GDDB6N	AC Motor 400V 3ph,37kW (236Nm rated, 589Nm peak) 800 rpm, 20bit IncEnc, Flange-mount	Sorunuz
SGMVV-4EDDB6N	AC Motor 400V 3ph,45kW (286Nm rated, 715Nm peak) 800 rpm, 20bit IncEnc, Flange-mount	19.172 EUR

### SGMVV Large Capacity Servo Motor 400V, 1.500 rpm - Foot-mounted Type

Ürün Kodu	Açıklama	Liste Fiyatı
SGMVV-2BD3BLN	AC Motor 400V 3ph,22kW (140Nm rated, 350Nm peak) 1.500 rpm, 20bit AbsEnc, Foot-mount	Sorunuz
SGMVV-3ZD3BLN	AC Motor 400V 3ph,30kW (191Nm rated, 478Nm peak) 1.500 rpm, 20bit AbsEnc, Foot-mount	Sorunuz
SGMVV-3GD3BLN	AC Motor 400V 3ph,37kW (236Nm rated, 589Nm peak) 1.500 rpm, 20bit AbsEnc, Foot-mount	13.148 EUR
SGMVV-4ED3BLN	AC Motor 400V 3ph,45kW (286Nm rated, 715Nm peak) 1.500 rpm, 20bit AbsEnc, Foot-mount	13.499 EUR
SGMVV-5ED3BLN	AC Motor 400V 3ph,55kW (350Nm rated, 875Nm peak) 1.500 rpm, 20bit AbsEnc, Foot-mount	Sorunuz
SGMVV-2BDDBLN	AC Motor 400V 3ph,22kW (140Nm rated, 350Nm peak) 1.500 rpm, 20bit IncEnc, Foot-mount	Sorunuz
SGMVV-3ZDDBLN	AC Motor 400V 3ph,30kW (191Nm rated, 478Nm peak) 1.500 rpm, 20bit IncEnc, Foot-mount	Sorunuz
SGMVV-3GDDBLN	AC Motor 400V 3ph,37kW (236Nm rated, 589Nm peak) 1.500 rpm, 20bit IncEnc, Foot-mount	12.796 EUR
SGMVV-4EDDBLN	AC Motor 400V 3ph,45kW (286Nm rated, 715Nm peak) 1.500 rpm, 20bit IncEnc, Foot-mount	Sorunuz
SGMVV-5EDDBLN	AC Motor 400V 3ph,55kW (350Nm rated, 875Nm peak) 1.500 rpm, 20bit IncEnc, Foot-mount	Sorunuz

### SGMVV Large Capacity Servo Motor 400V, 800 rpm - Foot-mounted Type

Ürün Kodu	Açıklama	Liste Fiyatı
SGMVV-2BD3DLN	AC Motor 400V 3ph,22kW (140Nm rated, 350Nm peak) 800 rpm, 20bit AbsEnc, Foot-mount	Sorunuz
SGMVV-3ZD3DLN	AC Motor 400V 3ph,30kW (191Nm rated, 478Nm peak) 800 rpm, 20bit AbsEnc, Foot-mount	Sorunuz
SGMVV-3GD3DLN	AC Motor 400V 3ph,37kW (236Nm rated, 589Nm peak) 800 rpm, 20bit AbsEnc, Foot-mount	Sorunuz
SGMVV-4ED3DLN	AC Motor 400V 3ph,45kW (286Nm rated, 715Nm peak) 800 rpm, 20bit AbsEnc, Foot-mount	Sorunuz
SGMVV-2BDDDLN	AC Motor 400V 3ph,22kW (140Nm rated, 350Nm peak) 800 rpm, 20bit IncEnc, Foot-mount	Sorunuz
SGMVV-3ZDDDLN	AC Motor 400V 3ph,30kW (191Nm rated, 478Nm peak) 800 rpm, 20bit IncEnc, Foot-mount	Sorunuz
SGMVV-3GDDDLN	AC Motor 400V 3ph,37kW (236Nm rated, 589Nm peak) 800 rpm, 20bit IncEnc, Foot-mount	Sorunuz
SGMVV-4EDDDLN	AC Motor 400V 3ph,45kW (286Nm rated, 715Nm peak) 800 rpm, 20bit IncEnc, Foot-mount	21.806 EUR

## SGMVV Large Capacity Servo Motor 400V, 1.500 rpm - Flange-mounted Type + Brake

Ürün Kodu	Açıklama	Liste Fiyatı
SGMVV-2BD3B6G	AC Motor 400V 3ph,22kW (140Nm rated, 350Nm peak) 1.500 rpm, Brake+DustSeal, Flange-mount	14.652 EUR
SGMVV-3ZD3B6G	AC Motor 400V 3ph,30kW (191Nm rated, 478Nm peak) 1.500 rpm, Brake+DustSeal, Flange-mount	15.296 EUR
SGMVV-3GD3B6G	AC Motor 400V 3ph,37kW (236Nm rated, 589Nm peak) 1.500 rpm, Brake+DustSeal, Flange-mount	17.674 EUR
SGMVV-4ED3B6G	AC Motor 400V 3ph,45kW (286Nm rated, 715Nm peak) 1.500 rpm, Brake+DustSeal, Flange-mount	23.120 EUR
SGMVV-5ED3B6G	AC Motor 400V 3ph,55kW (350Nm rated, 875Nm peak) 1.500 rpm, Brake+DustSeal, Flange-mount	Sorunuz
SGMVV-2BDDB6G	AC Motor 400V 3ph,22kW (140Nm rated, 350Nm peak) 1.500 rpm, Brake+DustSeal, Flange-mount	14.557 EUR
SGMVV-3ZDDB6G	AC Motor 400V 3ph,30kW (191Nm rated, 478Nm peak) 1.500 rpm, Brake+DustSeal, Flange-mount	15.201 EUR
SGMVV-3GDDB6G	AC Motor 400V 3ph,37kW (236Nm rated, 589Nm peak) 1.500 rpm, Brake+DustSeal, Flange-mount	17.573 EUR
SGMVV-4EDDB6G	AC Motor 400V 3ph,45kW (286Nm rated, 715Nm peak) 1.500 rpm, Brake+DustSeal, Flange-mount	23.020 EUR
SGMVV-5EDDB6G	AC Motor 400V 3ph,55kW (350Nm rated, 875Nm peak) 1.500 rpm, Brake+DustSeal, Flange-mount	Sorunuz

## SGMVV Large Capacity Servo Motor 400V, 800 rpm - Flange-mounted Type + Brake

Ürün Kodu	Açıklama	Liste Fiyatı
SGMVV-2BD3D6G	AC Motor 400V 3ph,22kW (140Nm rated, 350Nm peak) 800 rpm, Brake+DustSeal, Flange-mount	18.369 EUR
SGMVV-3ZD3D6G	AC Motor 400V 3ph,30kW (191Nm rated, 478Nm peak) 800 rpm, Brake+DustSeal, Flange-mount	Sorunuz
SGMVV-3GD3D6G	AC Motor 400V 3ph,37kW (236Nm rated, 589Nm peak) 800 rpm, Brake+DustSeal, Flange-mount	Sorunuz
SGMVV-4ED3D6G	AC Motor 400V 3ph,45kW (286Nm rated, 715Nm peak) 800 rpm, Brake+DustSeal, Flange-mount	Sorunuz
SGMVV-2BDDB6G	AC Motor 400V 3ph,22kW (140Nm rated, 350Nm peak) 800 rpm, Brake+DustSeal, Flange-mount	18.270 EUR
SGMVV-3ZDDB6G	AC Motor 400V 3ph,30kW (191Nm rated, 478Nm peak) 800 rpm, Brake+DustSeal, Flange-mount	Sorunuz
SGMVV-3GDDB6G	AC Motor 400V 3ph,37kW (236Nm rated, 589Nm peak) 800 rpm, Brake+DustSeal, Flange-mount	Sorunuz
SGMVV-4EDDB6G	AC Motor 400V 3ph,45kW (286Nm rated, 715Nm peak) 800 rpm, Brake+DustSeal, Flange-mount	Sorunuz

## SGMVV Large Capacity Servo Motor 400V, 1.500 rpm - Foot-mounted Type + Brake

Ürün Kodu	Açıklama	Liste Fiyatı
SGMVV-2BD3BLG	AC Motor 400V 3ph,22kW (140Nm rated, 350Nm peak) 1.500 rpm, Brake+DustSeal, Foot-mount	15.597 EUR
SGMVV-3ZD3BLG	AC Motor 400V 3ph,30kW (191Nm rated, 478Nm peak) 1.500 rpm, Brake+DustSeal, Foot-mount	16.239 EUR
SGMVV-3GD3BLG	AC Motor 400V 3ph,37kW (236Nm rated, 589Nm peak) 1.500 rpm, Brake+DustSeal, Foot-mount	18.960 EUR
SGMVV-4ED3BLG	AC Motor 400V 3ph,45kW (286Nm rated, 715Nm peak) 1.500 rpm, Brake+DustSeal, Foot-mount	24.950 EUR
SGMVV-5ED3BLG	AC Motor 400V 3ph,55kW (350Nm rated, 875Nm peak) 1.500 rpm, Brake+DustSeal, Foot-mount	29.110 EUR
SGMVV-2BDDBLG	AC Motor 400V 3ph,22kW (140Nm rated, 350Nm peak) 1.500 rpm, Brake+DustSeal, Foot-mount	15.496 EUR
SGMVV-3ZDDBLG	AC Motor 400V 3ph,30kW (191Nm rated, 478Nm peak) 1.500 rpm, Brake+DustSeal, Foot-mount	16.139 EUR
SGMVV-3GDDBLG	AC Motor 400V 3ph,37kW (236Nm rated, 589Nm peak) 1.500 rpm, Brake+DustSeal, Foot-mount	18.860 EUR
SGMVV-4EDDBLG	AC Motor 400V 3ph,45kW (286Nm rated, 715Nm peak) 1.500 rpm, Brake+DustSeal, Foot-mount	24.855 EUR
SGMVV-5EDDBLG	AC Motor 400V 3ph,55kW (350Nm rated, 875Nm peak) 1.500 rpm, Brake+DustSeal, Foot-mount	29.010 EUR

## SGMVV Large Capacity Servo Motor 400V, 800 rpm - Foot-mounted Type + Brake

Ürün Kodu	Açıklama	Liste Fiyatı
SGMVV-2BD3DLG	AC Motor 400V 3ph,22kW (140Nm rated, 350Nm peak) 800 rpm, Brake+DustSeal, Foot-mount	19.308 EUR
SGMVV-3ZD3DLG	AC Motor 400V 3ph,30kW (191Nm rated, 478Nm peak) 800 rpm, Brake+DustSeal, Foot-mount	26.337 EUR
SGMVV-3GD3DLG	AC Motor 400V 3ph,37kW (236Nm rated, 589Nm peak) 800 rpm, Brake+DustSeal, Foot-mount	33.765 EUR
SGMVV-4ED3DLG	AC Motor 400V 3ph,45kW (286Nm rated, 715Nm peak) 800 rpm, Brake+DustSeal, Foot-mount	Sorunuz
SGMVV-2BDDBLG	AC Motor 400V 3ph,22kW (140Nm rated, 350Nm peak) 800 rpm, Brake+DustSeal, Foot-mount	19.208 EUR
SGMVV-3ZDDBLG	AC Motor 400V 3ph,30kW (191Nm rated, 478Nm peak) 800 rpm, Brake+DustSeal, Foot-mount	26.237 EUR
SGMVV-3GDDBLG	AC Motor 400V 3ph,37kW (236Nm rated, 589Nm peak) 800 rpm, Brake+DustSeal, Foot-mount	33.665 EUR
SGMVV-4EDDBLG	AC Motor 400V 3ph,45kW (286Nm rated, 715Nm peak) 800 rpm, Brake+DustSeal, Foot-mount	Sorunuz

## SGMVV Large Capacity Servo Motor Power Cable

Ürün Kodu	Açıklama	Liste Fiyatı
	Yaskawa does not offer the motor power cable. Please check the terminal screw sizes on the motors terminal box and servopack main circuit wire and obtain suitable materials.	

## SGMVV Large Capacity Servo Motor Fan Cable

Ürün Kodu	Açıklama	Liste Fiyatı
JZSP-CVMCA11-03-E-G5	Flexible Angled Connector CE05 Fan cable(3m) for SGMVV	220 EUR
JZSP-CVMCA11-05-E-G5	Flexible Angled Connector CE05 Fan cable(5m) for SGMVV	258 EUR
JZSP-CVMCA11-10-E-G5	Flexible Angled Connector CE05 Fan cable(10m) for SGMVV	312 EUR
JZSP-CVMCA11-15-E-G5	Flexible Angled Connector CE05 Fan cable(15m) for SGMVV	379 EUR
JZSP-CVMCA11-20-E-G5	Flexible Angled Connector CE05 Fan cable(20m) for SGMVV	443 EUR

## SGMVV Incremental Encoder Angled Cable Flexible\*

Ürün Kodu	Açıklama	Liste Fiyatı
JZSP-CMP12-03-E	Flexible Incremental Encoder Angled Connector Cable(3m) for SGMVV	281 EUR
JZSP-CMP12-05-E	Flexible Incremental Encoder Angled Connector Cable(5m) for SGMVV	358 EUR
JZSP-CMP12-10-E	Flexible Incremental Encoder Angled Connector Cable(10m) for SGMVV	568 EUR
JZSP-CMP12-15-E	Flexible Incremental Encoder Angled Connector Cable(15m) for SGMVV	702 EUR
JZSP-CMP12-20-E	Flexible Incremental Encoder Angled Connector Cable(20m) for SGMVV	931 EUR

## Special Cable for Absolut Encoder

Ürün Kodu	Açıklama	Liste Fiyatı
JZSP-CSP12-E-G5	Extension Encoder cable with Connectors length 0.3m for Abs. Encoder, incl. Battery	100 EUR

## SGMVV Absolute Encoder Angled Cable Standard

Ürün Kodu	Açıklama	Liste Fiyatı
JZSP-CSP07-03-E	Standard Absolute Encoder Angled Connector cable (3m) for SGMVV	352 EUR
JZSP-CSP07-05-E	Standard Absolute Encoder Angled Connector cable (5m) for SGMVV	379 EUR
JZSP-CSP07-10-E	Standard Absolute Encoder Angled Connector cable (10m) for SGMVV	447 EUR
JZSP-CSP07-15-E	Standard Absolute Encoder Angled Connector cable (15m) for SGMVV	515 EUR
JZSP-CSP07-20-E	Standard Absolute Encoder Angled Connector cable (20m) for SGMVV	583 EUR

## Dynamic Brake Unit for SGMVV

Ürün Kodu	Açıklama	Liste Fiyatı
JUSP-DB04-E	DB Resistor Unit for 37kW, 400V Class	1.514 EUR
JUSP-DB06-E	DB Resistor Unit for 55kW, 400V Class	1.823 EUR

## Encoder Connector Kit for SGMVV

Ürün Kodu	Açıklama	Liste Fiyatı
JZSP-CMP9-1-E-G1	Connector Kit Encoder for CN2 servopack end	20 EUR



## Linear Motor - SGLGW Type with SGLGM Magnet Track

- @ Coreless Type
- @ 230V
- @ Standard Force rated 12.5 - 325 N, peak 40 - 1300 N
- @ High Force rated 57 - 255 N, peak 230 - 1080 N
- @ Direct-feed mechanism for high-speed and high-precision positioning
- @ Lack of magnetic attraction force helps extend the life of linear motion guides and minimizes noise
- @ Zero cogging for minimal force ripple
- @ CE-certified

### Linear Motor SGLGW-Type Coreless Type 200V (-E RoHS2 compliant)

Ürün Kodu	Açıklama	Liste Fiyatı
SGLGW-30A050CP-E	Moving Coil 3AC 200V Rated/Peak Force 12.5N / 40N w/ Hall Sensor	Sorunuz
SGLGW-30A050CPD-E	Moving Coil 3AC 200V Rated/Peak Force 12.5N / 40N w/ Hall Sensor Inter. Conn.	1.874 EUR
SGLGW-30A080CP-E	Moving Coil 3AC 200V Rated/Peak Force 25N / 80N w/ Hall Sensor	Sorunuz
SGLGW-30A080CPD-E	Moving Coil 3AC 200V Rated/Peak Force 25N / 80N w/ Hall Sensor Inter. Conn.	2.005 EUR
SGLGW-40A140CP-E	Moving Coil 3AC 200V Rated/Peak Force 47N / 140N w Hall Sensor	Sorunuz
SGLGW-40A140CHD-E	Moving Coil 3AC 200V Rated/Peak Force 47N / 140N w Hall Sensor & forced cooling Inter. Conn.	Sorunuz
SGLGW-40A140CPD-E	Moving Coil 3AC 200V Rated/Peak Force 47N / 140N w/ Hall Sensor Inter. Conn.	1.492 EUR
SGLGW-40A253CP-E	Moving Coil 3AC 200V Rated/Peak Force 93N / 280N w/ Hall Sensor	Sorunuz
SGLGW-40A253CHD-E	Moving Coil 3AC 200V Rated/Peak Force 93N / 280N w Hall Sensor & forced cooling Inter. Conn.	Sorunuz
SGLGW-40A253CPD-E	Moving Coil 3AC 200V Rated/Peak Force 93N / 280N w/ Hall Sensor Inter. Conn.	1.998 EUR
SGLGW-40A365CP-E	Moving Coil 3AC 200V Rated/Peak Force 140N / 420N w/ Hall Sensor	Sorunuz
SGLGW-40A365CHD-E	Moving Coil 3AC 200V Rated/Peak Force 140N / 420N w Hall Sensor&forced cooling Inter. Conn.	Sorunuz
SGLGW-40A365CPD-E	Moving Coil 3AC 200V Rated/Peak Force 140N / 420N w/ Hall Sensor Inter. Conn.	Sorunuz
SGLGW-60A140CP-E	Moving Coil 3AC 200V Rated/Peak Force 70N / 220N w Hall Sensor	Sorunuz
SGLGW-60A140CHD-E	Moving Coil 3AC 200V Rated/Peak Force 70N / 220N w Hall Sensor & forced cooling Inter. Conn.	1.361 EUR
SGLGW-60A140CPD-E	Moving Coil 3AC 200V Rated/Peak Force 70N / 220N w Hall Sensor Inter. Conn.	1.484 EUR
SGLGW-60A253CP-E	Moving Coil 3AC 200V Rated/Peak Force 140N / 440N w Hall Sensor	Sorunuz
SGLGW-60A253CHD-E	Moving Coil 3AC 200V Rated/Peak Force 140N / 440N w Hall Sensor&forced cooling Inter. Conn.	2.242 EUR
SGLGW-60A253CPD-E	Moving Coil 3AC 200V Rated/Peak Force 140N / 440N w Hall Sensor Inter. Conn.	2.016 EUR
SGLGW-60A365CP-E	Moving Coil 3AC 200V Rated/Peak Force 210N / 660N w Hall Sensor	Sorunuz
SGLGW-60A365CHD-E	Moving Coil 3AC 200V Rated/Peak Force 210N / 660N w Hall Sensor&forced cooling Inter. Conn.	2.567 EUR
SGLGW-60A365CPD-E	Moving Coil 3AC 200V Rated/Peak Force 210N / 660N w Hall Sensor Inter. Conn.	2.234 EUR
SGLGW-90A200CP-E	Moving Coil 3AC 200V Rated/Peak Force 325N / 1300N w/ Hall Sensor	Sorunuz
SGLGW-90A200CHD-E	Moving Coil 3AC 200V Rated/Peak Force 325N/1300N w/ Hall Sensor&forced cooling Inter. Conn.	2.961 EUR
SGLGW-90A200CPD-E	Moving Coil 3AC 200V Rated/Peak Force 325N / 1300N w/ Hall Sensor Inter. Conn.	2.679 EUR
SGLGW-90A370CP-E	Moving Coil 3AC 200V Rated/Peak Force 550N / 2200N w/ Hall Sensor	Sorunuz
SGLGW-90A370CHD-E	Moving Coil 3AC 200V Rated/Peak Force 550N/2200N w/ Hall Sensor&forced cooling Inter. Conn.	3.823 EUR
SGLGW-90A370CPD-E	Moving Coil 3AC 200V Rated/Peak Force 550N / 2200N w/ Hall Sensor Inter. Conn.	3.692 EUR

Ürün Kodu	Açıklama	Liste Fiyatı
SGLGM-30108A-E	Magnetic Way Length 108mm for SGLGW-30xxxx-E	495 EUR
SGLGM-30216A-E	Magnetic Way Length 216mm for SGLGW-30xxxx-E	Sorunuz
SGLGM-30432A-E	Magnetic Way Length 432mm for SGLGW-30xxxx-E	Sorunuz
SGLGM-40090CT-E	Magnetic Way Standard-force Length 90mm for SGLGW-40xxxx-E w/ Bottom Mounting Screws	442 EUR
SGLGM-40090CT-M-E	Magnetic Way High-force Length 90mm for SGLGW-40xxxx-E w/ Bottom Mounting Screws	Sorunuz
SGLGM-40225CT-E	Magnetic Way Standard-force Length 225mm for SGLGW-40xxxx-E w/ Bottom Mounting Screws	668 EUR
SGLGM-40225CT-M-E	Magnetic Way High-force Length 225mm for SGLGW-40xxxx-E w/ Bottom Mounting Screws	Sorunuz
SGLGM-40360CT-E	Magnetic Way Standard-force Length 360mm for SGLGW-40xxxx-E w/ Bottom Mounting Screws	933 EUR
SGLGM-40360CT-M-E	Magnetic Way High-force Length 360mm for SGLGW-40xxxx-E w/ Bottom Mounting Screws	2.062 EUR
SGLGM-40405CT-E	Magnetic Way Standard-force Length 405mm for SGLGW-40xxxx-E w/ Bottom Mounting Screws	Sorunuz
SGLGM-40405CT-M-E	Magnetic Way High-force Length 405mm for SGLGW-40xxxx-E w/ Bottom Mounting Screws	2.223 EUR
SGLGM-40450CT-E	Magnetic Way Standard-force Length 450mm for SGLGW-40xxxx-E w/ Bottom Mounting Screws	1.146 EUR
SGLGM-40450CT-M-E	Magnetic Way High-force Length 450mm for SGLGW-40xxxx-E w/ Bottom Mounting Screws	Sorunuz
SGLGM-60090CT-E	Magnetic Way Standard-force Length 90mm for SGLGW-60xxxx-E w/ Bottom Mounting Screws	518 EUR
SGLGM-60090CT-M-E	Magnetic Way High-force Length 90mm for SGLGW-60xxxx-E w/ Bottom Mounting Screws	622 EUR
SGLGM-60225CT-E	Magnetic Way Standard-force Length 225mm for SGLGW-60xxxx-E w/ Bottom Mounting Screws	824 EUR
SGLGM-60225CT-M-E	Magnetic Way High-force Length 225mm for SGLGW-60xxxx-E w/ Bottom Mounting Screws	1.118 EUR
SGLGM-60360CT-E	Magnetic Way Standard-force Length 360mm for SGLGW-60xxxx-E w/ Bottom Mounting Screws	1.158 EUR
SGLGM-60360CT-M-E	Magnetic Way High-force Length 360mm for SGLGW-60xxxx-E w/ Bottom Mounting Screws	1.638 EUR
SGLGM-60405CT-E	Magnetic Way Standard-force Length 405mm for SGLGW-60xxxx-E w/ Bottom Mounting Screws	1.327 EUR
SGLGM-60405CT-M-E	Magnetic Way High-force Length 405mm for SGLGW-60xxxx-E w/ Bottom Mounting Screws	1.829 EUR
SGLGM-60450CT-E	Magnetic Way Standard-force Length 450mm for SGLGW-60xxxx-E w/ Bottom Mounting Screws	1.463 EUR
SGLGM-60450CT-M-E	Magnetic Way High-force Length 450mm for SGLGW-60xxxx-E w/ Bottom Mounting Screws	2.096 EUR
SGLGM-90252A-E	Magnetic Way Standard-force Length 252mm for SGLGW-90xxxx-E	2.372 EUR
SGLGM-90504A-E	Magnetic Way Standard-force Length 504mm for SGLGW-90xxxx-E	3.972 EUR

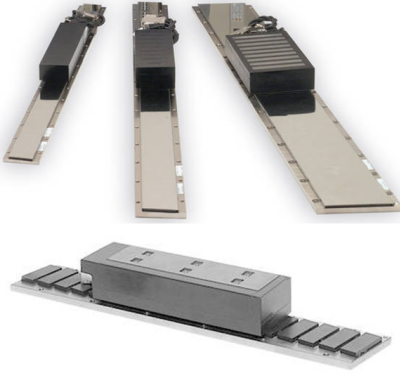

## Linear Motor - SGLFW Type with SGLFM Magnet Track

- @ Iron-core Type
- @ 230V & 400V
- @ 230V: Force rated 25 - 560 N, peak 86 - 1200 N
- @ 400V: Force rated 80 - 2250 N, peak 220 - 5400 N
- @ Direct-feed mechanism for high-speed and high-precision positioning
- @ The magnetic attraction force between the moving and stationary members can be used effectively to increase the rigidity of the linear guidance by preloading the linear motion bearings
- @ The magnetic preloading on certain types of compliant linear motion bearings can help increase the system's frequency response, improving its deceleration and settling performances.
- @ CE-certified

### Linear Motor SGLFW-Type Iron-core-Type 200V (-E RoHs2 compliant)

Ürün Kodu	Açıklama	Liste Fiyatı
SGLFW-20A090AP-E	Moving Coil 3AC 200V Rated Force 25N Peak Force 86N w/ Hall Sensor	Sorunuz
SGLFW-20A090APD-E	Moving Coil 3AC 200V Rated Force 25N Peak Force 86N w/ Hall Sensor Inter. Conn.	Sorunuz
SGLFW-20A120AP-E	Moving Coil 3AC 200V Rated Force 40N Peak Force 125N w/ Hall Sensor	Sorunuz
SGLFW-20A120APD-E	Moving Coil 3AC 200V Rated Force 40N Peak Force 125N w/ Hall Sensor Inter. Conn.	1.181 EUR
SGLFW-35A120AP-E	Moving Coil 3AC 200V Rated Force 80N Peak Force 220N w/ Hall Sensor	1.637 EUR
SGLFW-35A120APD-E	Moving Coil 3AC 200V Rated Force 80N Peak Force 220N w/ Hall Sensor Inter. Conn.	1.204 EUR
SGLFW-35A230AP-E	Moving Coil 3AC 200V Rated Force 160N Peak Force 440N w/ Hall Sensor	2.139 EUR
SGLFW-35A230APD-E	Moving Coil 3AC 200V Rated Force 160N Peak Force 440N w/ Hall Sensor Inter. Conn.	1.612 EUR
SGLFW-50A200BP-E	Moving Coil 3AC 200V Rated Force 280N Peak Force 600N w/ Hall Sensor	1.027 EUR
SGLFW-50A200BPD-E	Moving Coil 3AC 200V Rated Force 280N Peak Force 600N w/ Hall Sensor Inter. Conn.	1.118 EUR
SGLFW-50A380BP-E	Moving Coil 3AC 200V Rated Force 560N Peak Force 1200N w/ Hall Sensor	Sorunuz
SGLFW-50A380BPD-E	Moving Coil 3AC 200V Rated Force 560N Peak Force 1200N w/ Hall Sensor Inter. Conn.	1.852 EUR
SGLFW-1ZA200BP-E	Moving Coil 3AC 200V Rated Force 560N Peak Force 1200N w/ Hall Sensor	1.308 EUR
SGLFW-1ZA200BPD-E	Moving Coil 3AC 200V Rated Force 560N Peak Force 1200N w/ Hall Sensor Inter. Conn.	1.409 EUR
SGLFW-1ZA380BP-E	Moving Coil 3AC 200V Rated Force 1120N Peak Force 2400N w/ Hall Sensor	2.047 EUR
SGLFW-1ZA380BPD-E	Moving Coil 3AC 200V Rated Force 1120N Peak Force 2400N w/ Hall Sensor Inter. Conn.	2.025 EUR

### Linear Motor SGLFW-Type Iron-core-Type 400V (-E RoHs2 compliant)

Ürün Kodu	Açıklama	Liste Fiyatı
SGLFW-35D120AP-E	Moving Coil 3AC 400V Rated Force 80N Peak Force 220N w/ Hall Sensor	1.166 EUR
SGLFW-35D120APD-E	Moving Coil 3AC 400V Rated Force 80N Peak Force 220N w/ Hall Sensor Inter. Conn.	1.308 EUR
SGLFW-35D230AP-E	Moving Coil 3AC 400V Rated Force 160N Peak Force 440N w/ Hall Sensor	Sorunuz
SGLFW-35D230APD-E	Moving Coil 3AC 400V Rated Force 160N Peak Force 440N w/ Hall Sensor Inter. Conn.	1.698 EUR
SGLFW-50D200BP-E	Moving Coil 3AC 400V Rated Force 280N Peak Force 600N w/ Hall Sensor	794 EUR
SGLFW-50D200BPD-E	Moving Coil 3AC 400V Rated Force 280N Peak Force 600N w/ Hall Sensor Inter. Conn.	1.118 EUR
SGLFW-50D380BP-E	Moving Coil 3AC 400V Rated Force 560N Peak Force 1200N w/ Hall Sensor	Sorunuz
SGLFW-50D380BPD-E	Moving Coil 3AC 400V Rated Force 560N Peak Force 1200N w/ Hall Sensor Inter. Conn.	1.852 EUR
SGLFW-1ZD200BP-E	Moving Coil 3AC 400V Rated Force 560N Peak Force 1200N w/ Hall Sensor	Sorunuz
SGLFW-1ZD200BPD-E	Moving Coil 3AC 400V Rated Force 560N Peak Force 1200N w/ Hall Sensor Inter. Conn.	1.409 EUR
SGLFW-1ZD380BP-E	Moving Coil 3AC 400V Rated Force 1120N Peak Force 2400N w/ Hall Sensor	Sorunuz
SGLFW-1ZD380BPD-E	Moving Coil 3AC 400V Rated Force 1120N Peak Force 2400N w/ Hall Sensor Inter. Conn.	2.042 EUR
SGLFW-1ED380BP-E	Moving Coil 3AC 400V Rated Force 1500N Peak Force 3600N w/ Hall Sensor	3.785 EUR
SGLFW-1ED380BPD-E	Moving Coil 3AC 400V Rated Force 1500N Peak Force 3600N w/ Hall Sensor Inter. Conn.	Sorunuz
SGLFW-1ED560BP-E	Moving Coil 3AC 400V Rated Force 2250N Peak Force 5400N w/ Hall Sensor	5.146 EUR
SGLFW-1ED560BPD-E	Moving Coil 3AC 400V Rated Force 2250N Peak Force 5400N w/ Hall Sensor Inter. Conn.	Sorunuz

Ürün Kodu	Açıklama	Liste Fiyatı
SGLFM-20324A-E	Magnetic Way Length 324mm for SGLFW-20xxxx-E	Sorunuz
SGLFM-20324AC-E	Magnetic Way w/ magnet cover Length 324mm for SGLFW-20xxxx-E	659 EUR
SGLFM-20540A-E	Magnetic Way Length 540mm for SGLFW-20xxxx-E	Sorunuz
SGLFM-20540AC-E	Magnetic Way w/ magnet cover Length 540mm for SGLFW-20xxxx-E	1.041 EUR
SGLFM-20756A-E	Magnetic Way Length 756mm for SGLFW-20xxxx-E	Sorunuz
SGLFM-20756AC-E	Magnetic Way w/ magnet cover Length 756mm for SGLFW-20xxxx-E	Sorunuz
SGLFM-35324A-E	Magnetic Way Length 324mm for SGLFW-35xxxx-E	Sorunuz
SGLFM-35324AC-E	Magnetic Way w/ magnet cover Length 324mm for SGLFW-35xxxx-E	630 EUR
SGLFM-35540A-E	Magnetic Way Length 540mm for SGLFW-35xxxx-E	Sorunuz
SGLFM-35540AC-E	Magnetic Way w/ magnet cover Length 540mm for SGLFW-35xxxx-E	1.067 EUR
SGLFM-35756A-E	Magnetic Way Length 756mm for SGLFW-35xxxx-E	Sorunuz
SGLFM-35756AC-E	Magnetic Way w/ magnet cover Length 756mm for SGLFW-35xxxx-E	1.103 EUR
SGLFM-50405A-E	Magnetic Way Length 405mm for SGLFW-50xxxx-E	Sorunuz
SGLFM-50405AC-E	Magnetic Way w/ magnet cover Length 405mm for SGLFW-50xxxx-E	824 EUR
SGLFM-50675A-E	Magnetic Way Length 675mm for SGLFW-50xxxx-E	Sorunuz
SGLFM-50675AC-E	Magnetic Way w/ magnet cover Length 675mm for SGLFW-50xxxx-E	1.155 EUR
SGLFM-50945A-E	Magnetic Way Length 945mm for SGLFW-50xxxx-E	Sorunuz
SGLFM-50945AC-E	Magnetic Way w/ magnet cover Length 945mm for SGLFW-50xxxx-E	2.338 EUR
SGLFM-1Z135A-E	Magnetic Way Length 135mm for SGLFW-1Zxxxx-E	Sorunuz
SGLFM-1Z135AC-E	Magnetic Way w/ magnet cover Length 135mm for SGLFW-1Zxxxx-E	674 EUR
SGLFM-1Z405A-E	Magnetic Way Length 405mm for SGLFW-1Zxxxx-E	Sorunuz
SGLFM-1Z405AC-E	Magnetic Way w/ magnet cover Length 405mm for SGLFW-1Zxxxx-E	1.170 EUR
SGLFM-1Z675A-E	Magnetic Way Length 675mm for SGLFW-1Zxxxx-E	Sorunuz
SGLFM-1Z675AC-E	Magnetic Way w/ magnet cover Length 675mm for SGLFW-1Zxxxx-E	2.653 EUR
SGLFM-1Z945A-E	Magnetic Way Length 945mm for SGLFW-1Zxxxx-E	Sorunuz
SGLFM-1Z945AC-E	Magnetic Way w/ magnet cover Length 945mm for SGLFW-1Zxxxx-E	3.608 EUR
SGLFM-1E135A-E	Magnetic Way Length 135mm for SGLFW-1Exxxx-E	Sorunuz
SGLFM-1E135AC-E	Magnetic Way w/ magnet cover Length 135mm for SGLFW-1Exxxx-E	754 EUR



## Linear Motor - SGLFW2 Type with SGLFM2 Magnet Track

@ Iron-core Type  
 @ 230V & 400V  
 @ 230V: Force rated 45 - 2520 N, peak 135 - 7560 N  
 @ 400V: Force rated 45 - 2520 N, peak 135 - 7560 N  
 @ CE-certified



### Linear Motor SGLFW2-Type Iron-core-Type 200V without Hall Sensor (without "-E" RoHs2 compliant)

Ürün Kodu	Açıklama	Liste Fiyatı
SGLFW2-30A070AT1E	Moving Coil 3AC 200V Rated/Peak Force 45N / 135N w/o Hall Sensor	792 EUR
SGLFW2-30A120AT1E	Moving Coil 3AC 200V Rated/Peak Force 90N / 270N w/o Hall Sensor	900 EUR
SGLFW2-30A230AT1E	Moving Coil 3AC 200V Rated/Peak Force 180N / 540N w/o Hall Sensor	1.097 EUR
SGLFW2-45A200AT1E	Moving Coil 3AC 200V Rated/Peak Force 280N / 840N w/o Hall Sensor	1.418 EUR
SGLFW2-45A380AT1E	Moving Coil 3AC 200V Rated/Peak Force 560N / 1680N w/o Hall Sensor	1.629 EUR
SGLFW2-90A200AT1E	Moving Coil 3AC 200V Rated/Peak Force 560N / 1680N w/o Hall Sensor	1.793 EUR
SGLFW2-90A380AT1E	Moving Coil 3AC 200V Rated/Peak Force 1120N / 3360N w/o Hall Sensor	2.235 EUR
SGLFW2-90A560AT1E	Moving Coil 3AC 200V Rated/Peak Force 1680N / 5040N w/o Hall Sensor	2.440 EUR
SGLFW2-1DA380AT1E	Moving Coil 3AC 200V Rated/Peak Force 1680N / 5040N w/o Hall Sensor	2.536 EUR
SGLFW2-1DA560AT1E	Moving Coil 3AC 200V Rated/Peak Force 2520N / 7560N w/o Hall Sensor	2.799 EUR

### Linear Motor SGLFW2-Type Iron-core-Type 200V with Hall Sensor (without "-E" RoHs2 compliant)

Ürün Kodu	Açıklama	Liste Fiyatı
SGLFW2-30A070AS1E	Moving Coil 3AC 200V Rated/Peak Force 45N / 135N with Hall Sensor	769 EUR
SGLFW2-30A120AS1E	Moving Coil 3AC 200V Rated/Peak Force 90N / 270N with Hall Sensor	948 EUR
SGLFW2-30A230AS1E	Moving Coil 3AC 200V Rated/Peak Force 180N / 540N with Hall Sensor	1.045 EUR
SGLFW2-45A200AS1E	Moving Coil 3AC 200V Rated/Peak Force 280N / 840N with Hall Sensor	1.322 EUR
SGLFW2-45A380AS1E	Moving Coil 3AC 200V Rated/Peak Force 560N / 1680N with Hall Sensor	1.667 EUR
SGLFW2-90A200AS1E	Moving Coil 3AC 200V Rated/Peak Force 560N / 1680N with Hall Sensor	1.427 EUR
SGLFW2-90A380AS1E	Moving Coil 3AC 200V Rated/Peak Force 1120N / 3360N with Hall Sensor	1.768 EUR
SGLFW2-90A560AS1E	Moving Coil 3AC 200V Rated/Peak Force 1680N / 5040N with Hall Sensor	2.266 EUR
SGLFW2-1DA380AS1E	Moving Coil 3AC 200V Rated/Peak Force 1680N / 5040N with Hall Sensor	2.162 EUR
SGLFW2-1DA560AS1E	Moving Coil 3AC 200V Rated/Peak Force 2520N / 7560N with Hall Sensor	2.847 EUR

### Linear Motor SGLFW2-Type Iron-core-Type 400V without Hall Sensor (without "-E" RoHs2 compliant)

Ürün Kodu	Açıklama	Liste Fiyatı
SGLFW2-30D070AT1E	Moving Coil 3AC 400V Rated/Peak Force 45N / 135N w/o Hall Sensor	720 EUR
SGLFW2-30D120AT1E	Moving Coil 3AC 400V Rated/Peak Force 90N / 270N w/o Hall Sensor	900 EUR
SGLFW2-30D230AT1E	Moving Coil 3AC 400V Rated/Peak Force 180N / 540N w/o Hall Sensor	997 EUR
SGLFW2-45D200AT1E	Moving Coil 3AC 400V Rated/Peak Force 280N / 840N w/o Hall Sensor	1.103 EUR
SGLFW2-45D380AT1E	Moving Coil 3AC 400V Rated/Peak Force 560N / 1680N w/o Hall Sensor	1.450 EUR
SGLFW2-90D200AT1E	Moving Coil 3AC 400V Rated/Peak Force 560N / 1680N w/o Hall Sensor	1.379 EUR
SGLFW2-90D380AT1E	Moving Coil 3AC 400V Rated/Peak Force 1120N / 3360N w/o Hall Sensor	1.720 EUR
SGLFW2-90D560AT1E	Moving Coil 3AC 400V Rated/Peak Force 1680N / 5040N w/o Hall Sensor	2.218 EUR
SGLFW2-1DD380AT1E	Moving Coil 3AC 400V Rated/Peak Force 1680N / 5040N w/o Hall Sensor	2.113 EUR
SGLFW2-1DD560AT1E	Moving Coil 3AC 400V Rated/Peak Force 2520N / 7560N w/o Hall Sensor	2.800 EUR

## Linear Motor SGLFW2-Type Iron-core-Type 400V with Hall Sensor (without "-E" RoHs2 compliant)

Ürün Kodu	Açıklama	Liste Fiyatı
SGLFW2-30D070AS1E	Moving Coil 3AC 400V Rated/Peak Force 45N / 135N with Hall Sensor	769 EUR
SGLFW2-30D120AS1E	Moving Coil 3AC 400V Rated/Peak Force 90N / 270N with Hall Sensor	948 EUR
SGLFW2-30D230AS1E	Moving Coil 3AC 400V Rated/Peak Force 180N / 540N with Hall Sensor	1.045 EUR
SGLFW2-45D200AS1E	Moving Coil 3AC 400V Rated/Peak Force 280N / 840N with Hall Sensor	1.151 EUR
SGLFW2-45D380AS1E	Moving Coil 3AC 400V Rated/Peak Force 560N / 1680N with Hall Sensor	1.500 EUR
SGLFW2-90D200AS1E	Moving Coil 3AC 400V Rated/Peak Force 560N / 1680N with Hall Sensor	1.428 EUR
SGLFW2-90D380AS1E	Moving Coil 3AC 400V Rated/Peak Force 1120N / 3360N with Hall Sensor	1.768 EUR
SGLFW2-90D560AS1E	Moving Coil 3AC 400V Rated/Peak Force 1680N / 5040N with Hall Sensor	2.268 EUR
SGLFW2-1DD380AS1E	Moving Coil 3AC 400V Rated/Peak Force 1680N / 5040N with Hall Sensor	2.163 EUR
SGLFW2-1DD560AS1E	Moving Coil 3AC 400V Rated/Peak Force 2520N / 7560N with Hall Sensor	2.848 EUR

## Magnet Track for Linear Motor SGLFW2-Type (without "-E" RoHs2 compliant)

Ürün Kodu	Açıklama	Liste Fiyatı
SGLFM2-30270A	Magnetic Way Length 270mm for SGLFW2-30xxxxx	502 EUR
SGLFM2-30450A	Magnetic Way Length 450mm for SGLFW2-30xxxxx	670 EUR
SGLFM2-30630A	Magnetic Way Length 630mm for SGLFW2-30xxxxx	840 EUR
SGLFM2-45306A	Magnetic Way Length 306mm for SGLFW2-45xxxxx	604 EUR
SGLFM2-45510A	Magnetic Way Length 510mm for SGLFW2-45xxxxx	847 EUR
SGLFM2-45714A	Magnetic Way Length 714mm for SGLFW2-45xxxxx	1.094 EUR
SGLFM2-90306A	Magnetic Way Length 306mm for SGLFW2-90xxxxx	861 EUR
SGLFM2-90510A	Magnetic Way Length 510mm for SGLFW2-90xxxxx	1.236 EUR
SGLFM2-90714A	Magnetic Way Length 714mm for SGLFW2-90xxxxx	1.682 EUR
SGLFM2-1D306A	Magnetic Way Length 306mm for SGLFW2-1Dxxxxx	1.241 EUR
SGLFM2-1D510A	Magnetic Way Length 510mm for SGLFW2-1Dxxxxx	1.852 EUR
SGLFM2-1D714A	Magnetic Way Length 714mm for SGLFW2-1Dxxxxx	2.515 EUR



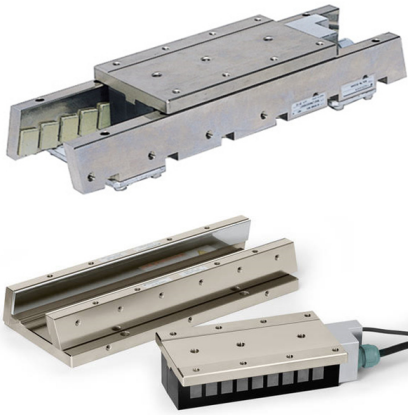

## Linear Motor - SGLTW Type with SGLTM Magnet Track

- @ Iron-core Type
- @ 230V & 400V
- @ 230V: Force rated 130 - 2000 N, peak 380 - 7500 N
- @ 400V: Force rated 300 - 2000 N, peak 600 - 7500 N
- @ Direct-feed mechanism for high-speed and high-precision positioning
- @ Yaskawa's unique construction principles of the TW linear motors negate the effects of the magnetic attraction force between the relative motor members
- @ Lack of magnetic attraction helps to extend the life of the linear motion guides and to minimize operation noise
- @ Very little cogging
- @ CE-certified

Linear Motor SGLTW-Type Iron-core-Type 200V (-E RoHs2 compliant)

Ürün Kodu	Açıklama	Liste Fiyatı
SGLTW-20A170AP-E	Moving Coil 3AC 200V Rated/Peak Force 130N / 380N w/ Hall Sensor	1.768 EUR
SGLTW-20A320AP-E	Moving Coil 3AC 200V Rated/Peak Force 250N / 760N w/ Hall Sensor	Sorunuz
SGLTW-20A460AP-E	Moving Coil 3AC 200V Rated/Peak Force 380N / 1140N w/ Hall Sensor	Sorunuz
SGLTW-35A170AP-E	Moving Coil 3AC 200V Rated/Peak Force 220N / 660N w/ Hall Sensor	Sorunuz
SGLTW-35A320AP-E	Moving Coil 3AC 200V Rated/Peak Force 440N / 1320N w/ Hall Sensor	Sorunuz
SGLTW-35A460AP-E	Moving Coil 3AC 200V Rated/Peak Force 670N / 2000N w/ Hall Sensor	Sorunuz
SGLTW-40A400AP-E	Moving Coil 3AC 200V Rated/Peak Force 670N / 2600N w/ Hall Sensor	Sorunuz
SGLTW-40A600AP-E	Moving Coil 3AC 200V Rated/Peak Force 1000N / 4000N w/ Hall Sensor	Sorunuz
SGLTW-80A400AP-E	Moving Coil 3AC 200V Rated/Peak Force 1300N / 5000N w/ Hall Sensor	Sorunuz
SGLTW-80A600AP-E	Moving Coil 3AC 200V Rated/Peak Force 2000N / 7500N w/ Hall Sensor	Sorunuz

Linear Motor SGLTW-Type Iron-core-Type 400V (-E RoHs2 compliant)

Ürün Kodu	Açıklama	Liste Fiyatı
SGLTW-35D170HP-E	Moving Coil 3AC 400V Rated/Peak Force 300N / 600N w/ Hall Sensor	Sorunuz
SGLTW-35D320HP-E	Moving Coil 3AC 400V Rated/Peak Force 600N / 1200N w/ Hall Sensor	Sorunuz
SGLTW-40D400BP-E	Moving Coil 3AC 400V Rated/Peak Force 670N / 2600N w/ Hall Sensor	Sorunuz
SGLTW-40D600BP-E	Moving Coil 3AC 400V Rated/Peak Force 1000N / 4000N w/ Hall Sensor	Sorunuz
SGLTW-50D170HP-E	Moving Coil 3AC 400V Rated/Peak Force 450N / 900N w/ Hall Sensor	5.298 EUR
SGLTW-50D320HP-E	Moving Coil 3AC 400V Rated/Peak Force 900N / 1800N w/ Hall Sensor	Sorunuz
SGLTW-80D400BP-E	Moving Coil 3AC 400V Rated/Peak Force 1300N / 5000N w/ Hall Sensor	Sorunuz
SGLTW-80D600BP-E	Moving Coil 3AC 400V Rated/Peak Force 2000N / 7500N w/ Hall Sensor	4.464 EUR

Magnet Track for Linear Motor SGLTW-Type (-E RoHs2 compliant)

Ürün Kodu	Açıklama	Liste Fiyatı
SGLTM-20324A-E	Magnetic Way Length 324mm for SGLTW-20xxxx-E	Sorunuz
SGLTM-20324AY-E	Magnetic Way w/ base and magnet cover Length 324mm for SGLTW-20xxxx-E	Sorunuz
SGLTM-20540A-E	Magnetic Way Length 540mm for SGLTW-20xxxx-E	Sorunuz
SGLTM-20540AY-E	Magnetic Way w/ base and magnet cover Length 540mm for SGLTW-20xxxx-E	Sorunuz
SGLTM-20756A-E	Magnetic Way Length 756mm for SGLTW-20xxxx-E	Sorunuz
SGLTM-20756AY-E	Magnetic Way w/ base and magnet cover Length 756mm for SGLTW-20xxxx-E	Sorunuz
SGLTM-35324A-E	Magnetic Way Length 324mm for SGLTW-35xxxx-E	Sorunuz
SGLTM-35324AC-E	Magnetic Way w/ magnet cover Length 324mm for SGLTW-35xxxx-E	Sorunuz
SGLTM-35324AY-E	Magnetic Way w/ base and magnet cover Length 324mm for SGLTW-35xxxx-E	Sorunuz
SGLTM-35540A-E	Magnetic Way Length 540mm for SGLTW-35xxxx-E	Sorunuz
SGLTM-35540AC-E	Magnetic Way w/ magnet cover Length 540mm for SGLTW-35xxxx-E	Sorunuz
SGLTM-35540AY-E	Magnetic Way w/ base and magnet cover Length 540mm for SGLTW-35xxxx-E	Sorunuz
SGLTM-35756A-E	Magnetic Way Length 756mm for SGLTW-35xxxx-E	Sorunuz
SGLTM-35756AC-E	Magnetic Way w/ magnet cover Length 756mm for SGLTW-35xxxx-E	Sorunuz
SGLTM-35756AY-E	Magnetic Way w/ base and magnet cover Length 756mm for SGLTW-35xxxx-E	Sorunuz
SGLTM-35324H-E	Magnetic Way High Eff. Type Length 324mm for SGLTW-35xxxx-E	Sorunuz
SGLTM-35324HC-E	Magnetic Way High Eff. Type w/ magnet cover Length 324mm for SGLTW-35xxxx-E	Sorunuz
SGLTM-35540H-E	Magnetic Way High Eff. Type Length 540mm for SGLTW-35xxxx-E	Sorunuz
SGLTM-35540HC-E	Magnetic Way High Eff. Type w/ magnet cover Length 540mm for SGLTW-35xxxx-E	Sorunuz
SGLTM-35756H-E	Magnetic Way High Eff. Type Length 756mm for SGLTW-35xxxx-E	Sorunuz
SGLTM-35756HC-E	Magnetic Way High Eff. Type w/ magnet cover Length 756mm for SGLTW-35xxxx-E	Sorunuz
SGLTM-40405A-E	Magnetic Way Length 405mm for SGLTW-40xxxx-E	Sorunuz
SGLTM-40405AC-E	Magnetic Way w/ magnet cover Length 405mm for SGLTW-40xxxx-E	Sorunuz
SGLTM-40405AY-E	Magnetic Way w/ base and magnet cover Length 405mm for SGLTW-40xxxx-E	Sorunuz
SGLTM-40675A-E	Magnetic Way Length 675mm for SGLTW-40xxxx-E	Sorunuz
SGLTM-40675AC-E	Magnetic Way w/ magnet cover Length 675mm for SGLTW-40xxxx-E	Sorunuz
SGLTM-40675AY-E	Magnetic Way w/ base and magnet cover Length 675mm for SGLTW-40xxxx-E	Sorunuz
SGLTM-40945A-E	Magnetic Way Length 945mm for SGLTW-40xxxx-E	3.677 EUR

SGLTM-40945AC-E	Magnetic Way w/ magnet cover Length 945mm for SGLTW-40xxxxx-E	Sorunuz
SGLTM-40945AY-E	Magnetic Way w/ base and magnet cover Length 945mm for SGLTW-40xxxxx-E	Sorunuz
SGLTM-50324H-E	Magnetic Way High Eff. Type Length 324mm for SGLTW-50xxxxx-E	Sorunuz
SGLTM-50324HC-E	Magnetic Way High Eff. Type w/ magnet cover Length 324mm for SGLTW-50xxxxx-E	Sorunuz
SGLTM-50540H-E	Magnetic Way High Eff. Type Length 540mm for SGLTW-50xxxxx-E	Sorunuz
SGLTM-50540HC-E	Magnetic Way High Eff. Type w/ magnet cover Length 540mm for SGLTW-50xxxxx-E	3.861 EUR
SGLTM-50756H-E	Magnetic Way High Eff. Type Length 756mm for SGLTW-50xxxxx-E	Sorunuz
SGLTM-50756HC-E	Magnetic Way High Eff. Type w/ magnet cover Length 756mm for SGLTW-50xxxxx-E	6.668 EUR
SGLTM-80405A-E	Magnetic Way Length 405mm for SGLTW-80xxxxx-E	Sorunuz
SGLTM-80405AC-E	Magnetic Way w/ magnet cover Length 405mm for SGLTW-80xxxxx-E	Sorunuz
SGLTM-80405AY-E	Magnetic Way w/ base and magnet cover Length 405mm for SGLTW-80xxxxx-E	Sorunuz
SGLTM-80675A-E	Magnetic Way Length 675mm for SGLTW-80xxxxx-E	Sorunuz
SGLTM-80675AC-E	Magnetic Way w/ magnet cover Length 675mm for SGLTW-80xxxxx-E	4.621 EUR
SGLTM-80675AY-E	Magnetic Way w/ base and magnet cover Length 675mm for SGLTW-80xxxxx-E	5.522 EUR
SGLTM-80945A-E	Magnetic Way Length 945mm for SGLTW-80xxxxx-E	Sorunuz
SGLTM-80945AC-E	Magnetic Way w/ magnet cover Length 945mm for SGLTW-80xxxxx-E	Sorunuz
SGLTM-80945AY-E	Magnetic Way w/ base and magnet cover Length 945mm for SGLTW-80xxxxx-E	7.590 EUR

**Serial Converter for Linear Motors in combination with Sigma 5 amplifiers (-E RoHs2 compliant)**

Ürün Kodu	Açıklama	Liste Fiyatı
JZDP-D006-XXX-E	Serial Converter with Hall Sensor, by HEIDENHAIN. 8 Bit resolution	574 EUR
JZDP-D008-XXX-E	Serial Converter with Hall Sensor, by RENISHAW. 8 Bit resolution	574 EUR
JZDP-G006-XXX-E	Serial Converter with Hall Sensor, by HEIDENHAIN. 12 Bit resolution	521 EUR
JZDP-G008-XXX-E	Serial Converter with Hall Sensor, by RENISHAW. 12 Bit resolution	521 EUR

## Serial Converter for Linear Motors in combination with Sigma 7 amplifiers (without "-E" RoHs2 compliant)

Ürün Kodu	Açıklama	Liste Fiyatı
JZDP-H003-000	Serial Converter for external Encoder Heidenhain, 8 bit resolution	521 EUR
JZDP-H005-000	Serial Converter for external Encoder Renishaw, 8 bit resolution	521 EUR
JZDP-H003-XXX	Serial Converter for external Encoder Heidenhain, 8 bit resolution	521 EUR
JZDP-H005-XXX	Serial Converter for external Encoder Renishaw, 8 bit resolution	521 EUR
JZDP-H006-XXX	Serial Converter with Hall Sensor, by HEIDENHAIN. 8 Bit resolution	478 EUR
JZDP-H008-XXX	Serial Converter with Hall Sensor, by RENISHAW. 8 Bit resolution	478 EUR
JZDP-J003-000	Serial Converter for external Encoder Heidenhain, 12 bit resolution	573 EUR
JZDP-J005-000	Serial Converter for external Encoder Renishaw, 12 bit resolution	573 EUR
JZDP-J003-XXX	Serial Converter for external Encoder Heidenhain, 12 bit resolution	573 EUR
JZDP-J005-XXX	Serial Converter for external Encoder Renishaw, 12 bit resolution	573 EUR
JZDP-J006-XXX	Serial Converter with Hall Sensor, by HEIDENHAIN. 12 Bit resolution	573 EUR
JZDP-J008-XXX	Serial Converter with Hall Sensor, by RENISHAW. 12 Bit resolution	573 EUR

## Serial Converter Cable to Servopack

Ürün Kodu	Açıklama	Liste Fiyatı
JZSP-CLP70-03-E-G5	Encoder cable with connectors CN2 & Serial Converter length 03m for Sigma II, V	161 EUR
JZSP-CLP70-05-E-G5	Encoder cable with connectors CN2 & Serial Converter length 05m for Sigma II, V	200 EUR
JZSP-CLP70-10-E-G5	Encoder cable with connectors CN2 & Serial Converter length 10m for Sigma II, V	295 EUR
JZSP-CLP70-15-E-G5	Encoder cable with connectors CN2 & Serial Converter length 15m for Sigma II, V	389 EUR

## Linear Servomotor Main Circuit Cables

Ürün Kodu	Açıklama	Liste Fiyatı
JZSP-CLN11-01-E	Linear Servomotor Main Circuit Cables with plastic connector length 1m	66 EUR
JZSP-CLN11-03-E	Linear Servomotor Main Circuit Cables with plastic connector length 3m	95 EUR
JZSP-CLN11-05-E	Linear Servomotor Main Circuit Cables with plastic connector length 5m	135 EUR
JZSP-CLN11-10-E	Linear Servomotor Main Circuit Cables with plastic connector length 10m	254 EUR
JZSP-CLN11-15-E	Linear Servomotor Main Circuit Cables with plastic connector length 15m	418 EUR
JZSP-CLN11-20-E	Linear Servomotor Main Circuit Cables with plastic connector length 20m	487 EUR
JZSP-CLN21-01-E	Linear Servomotor Main Circuit Cables with plastic connector length 1m	86 EUR
JZSP-CLN21-03-E	Linear Servomotor Main Circuit Cables with plastic connector length 3m	189 EUR
JZSP-CLN21-05-E	Linear Servomotor Main Circuit Cables with plastic connector length 5m	264 EUR
JZSP-CLN21-10-E	Linear Servomotor Main Circuit Cables with plastic connector length 10m	494 EUR
JZSP-CLN21-15-E	Linear Servomotor Main Circuit Cables with plastic connector length 15m	833 EUR
JZSP-CLN21-20-E	Linear Servomotor Main Circuit Cables with plastic connector length 20m	1.093 EUR
DP9325252-03G	Linear Servomotor Main Circuit Cables with circular connector length 3m for SGLXW-20+30	133 EUR
DP9325252-05G	Linear Servomotor Main Circuit Cables with circular connector length 5m for SGLXW-20+30	161 EUR
DP9325252-10G	Linear Servomotor Main Circuit Cables with circular connector length 10m for SGLXW-20+30	232 EUR
DP9325252-15G	Linear Servomotor Main Circuit Cables with circular connector length 15m for SGLXW-20+30	312 EUR
DP9325252-20G	Linear Servomotor Main Circuit Cables with circular connector length 20m for SGLXW-20+30	387 EUR
DP9325254-03G	Linear Servomotor Main Circuit Cables with circular connector length 3m for SGLXW-50+1ZA200	164 EUR
DP9325254-05G	Linear Servomotor Main Circuit Cables with circular connector length 5m for SGLXW-50+1ZA200	204 EUR
DP9325254-10G	Linear Servomotor Main Circuit Cables with circular connector length 10m for SGLXW-50+1ZA200	292 EUR
DP9325254-15G	Linear Servomotor Main Circuit Cables with circular connector length 15m for SGLXW-50+1ZA200	375 EUR
DP9325254-20G	Linear Servomotor Main Circuit Cables with circular connector length 20m for SGLXW-50+1ZA200	464 EUR
JZSP-CMM20D15-03G	Linear Servomotor Main Circuit Cables with circular connector length 3m SGLXW-20-1ZD200	158 EUR
JZSP-CMM20D15-05G	Linear Servomotor Main Circuit Cables with circular connector length 5m SGLXW-20-1ZD200	179 EUR
JZSP-CMM20D15-10G	Linear Servomotor Main Circuit Cables with circular connector length 10m SGLXW-20-1ZD200	224 EUR
JZSP-CMM20D15-15G	Linear Servomotor Main Circuit Cables with circular connector length 15m SGLXW-20-1ZD200	357 EUR
JZSP-CMM20D15-20G	Linear Servomotor Main Circuit Cables with circular connector length 20m SGLXW-20-1ZD200	452 EUR
JZSP-CVMCA13-03-E-G5	Linear Servomotor Main Circuit Cables with circular connector length 3m for SGLFW-1ED	290 EUR
JZSP-CVMCA13-05-E-G5	Linear Servomotor Main Circuit Cables with circular connector length 5m for SGLFW-1ED	332 EUR
JZSP-CVMCA13-10-E-G5	Linear Servomotor Main Circuit Cables with circular connector length 10m for SGLFW-1ED	406 EUR
JZSP-CVMCA13-15-E-G5	Linear Servomotor Main Circuit Cables with circular connector length 15m for SGLFW-1ED	481 EUR
JZSP-CVMCA13-20-E-G5	Linear Servomotor Main Circuit Cables with circular connector length 20m for SGLFW-1ED	574 EUR
JZSP-CLN39-01-E	Linear Servomotor Main Circuit Cables with plastic connector length 1m	131 EUR
JZSP-CLN39-03-E	Linear Servomotor Main Circuit Cables with plastic connector length 3m	321 EUR
JZSP-CLN39-05-E	Linear Servomotor Main Circuit Cables with plastic connector length 5m	511 EUR
JZSP-CLN39-10-E	Linear Servomotor Main Circuit Cables with plastic connector length 10m	991 EUR
JZSP-CLN39-15-E	Linear Servomotor Main Circuit Cables with plastic connector length 15m	1.481 EUR
JZSP-CLN39-20-E	Linear Servomotor Main Circuit Cables with plastic connector length 20m	1.959 EUR

## Linear Scale Cable to Serial Converter

Ürün Kodu	Açıklama	Liste Fiyatı
JZSP-CLL00-01-E	Cable for connecting Linear Scale (1m)	207 EUR
JZSP-CLL00-03-E	Cable for connecting Linear Scale (3m)	288 EUR
JZSP-CLL00-05-E	Cable for connecting Linear Scale (5m)	369 EUR
JZSP-CLL00-10-E	Cable for connecting Linear Scale (10m)	571 EUR
JZSP-CLL00-15-E	Cable for connecting Linear Scale (15m)	771 EUR

## Hall Sensor Cable to Serial Converter

Ürün Kodu	Açıklama	Liste Fiyatı
JZSP-CLL10-01-E	Cable for Connecting Hall Sensor (1m)	228 EUR
JZSP-CLL10-03-E	Cable for Connecting Hall Sensor (3m)	280 EUR
JZSP-CLL10-05-E	Cable for Connecting Hall Sensor (5m)	355 EUR
JZSP-CLL10-10-E	Cable for Connecting Hall Sensor (10m)	554 EUR
JZSP-CLL10-15-E	Cable for Connecting Hall Sensor (15m)	747 EUR

## Serial Converter Cable to Motor incl. Thermal protector & Hall Sensor

Ürün Kodu	Açıklama	Liste Fiyatı
JZSP-CL2L100-01-E	Sensor Cable from Serial Converter to Motor with Thermal protection & Hall Sensor for SGLFW2, 1m length	84 EUR
JZSP-CL2L100-03-E	Sensor Cable from Serial Converter to Motor with Thermal protection & Hall Sensor for SGLFW2, 3m length	116 EUR
JZSP-CL2L100-05-E	Sensor Cable from Serial Converter to Motor with Thermal protection & Hall Sensor for SGLFW2, 5m length	151 EUR
JZSP-CL2L100-10-E	Sensor Cable from Serial Converter to Motor with Thermal protection & Hall Sensor for SGLFW2, 10m length	236 EUR
JZSP-CL2L100-15-E	Sensor Cable from Serial Converter to Motor with Thermal protection & Hall Sensor for SGLFW2, 15m length	320 EUR

## Serial Converter Cable to Motor incl. Thermal protector w/o Hall Sensor

Ürün Kodu	Açıklama	Liste Fiyatı
JZSP-CL2TH00-01-E	Sensor Cable from Serial Converter to Motor with Thermal protection w/o Hall Sensor for SGLFW2, 1m length	57 EUR
JZSP-CL2TH00-03-E	Sensor Cable from Serial Converter to Motor with Thermal protection w/o Hall Sensor for SGLFW2, 3m length	70 EUR
JZSP-CL2TH00-05-E	Sensor Cable from Serial Converter to Motor with Thermal protection w/o Hall Sensor for SGLFW2, 5m length	84 EUR
JZSP-CL2TH00-10-E	Sensor Cable from Serial Converter to Motor with Thermal protection w/o Hall Sensor for SGLFW2, 10m length	122 EUR
JZSP-CL2TH00-15-E	Sensor Cable from Serial Converter to Motor with Thermal protection w/o Hall Sensor for SGLFW2, 15m length	158 EUR



Inverter GA700 400 VAC Three Phase - IP20

## GA700 Inverter

- @ 200VAC & 400VAC
- @ 0,55 - 355kW (following IEC motor frames)
- @ max. output frequency: 590Hz
- @ DC reactor build in, from 22kW HD upwards
- @ Braking transistor build in,  
up to 75kW HD (400V), 30kW HD (200V)
- @ EMC class C3 filter built in
- @ 24Vdc power supply built in
- @ Built in SIL3 Cat.3 PLe for STO
- @ Coated PCB's
- @ PLC logic in the drive can replace timers, relais, PLC's
- @ Motor control: IM, IPM, SPM, SRM - open or closed loop,  
open loop torque control
- @ 8 digital, 3 analogue, 1 pulse input, multifunctional  
Dual channel SIL3 STO input
- @ 4 digital, 2 x analogue, 1 pulse output, multifunctional
- @ Standards: CE, UL, cUL, TUV, EAC, RoHS

Ürün Kodu	Açıklama	Liste Fiyatı
CIPR-GA70C4002BBAA-BAAAAA	Inverter GA700, 400 V, ND: 2,1 A / 0,75 kW, HD: 1,8 A / 0,55 kW, IP20	693 EUR
CIPR-GA70C4004BBAA-BAAAAA	Inverter GA700, 400 V, ND: 4,1 A / 1,50 kW, HD: 3,4 A / 0,75 kW, IP20	717 EUR
CIPR-GA70C4005BBAA-BAAAAA	Inverter GA700, 400 V, ND: 5,4 A / 2,20 kW, HD: 4,8 A / 1,50 kW, IP20	772 EUR
CIPR-GA70C4007BBAA-BAAAAA	Inverter GA700, 400 V, ND: 7,1 A / 3,00 kW, HD: 5,5 A / 2,20 kW, IP20	828 EUR
CIPR-GA70C4009BBAA-BAAAAA	Inverter GA700, 400 V, ND: 8,9 A / 4,00 kW, HD: 7,2 A / 3,00 kW, IP20	879 EUR
CIPR-GA70C4012BBAA-BAAAAA	Inverter GA700, 400 V, ND: 11,9 A / 5,5 kW, HD: 9,2 A / 3,70 kW, IP20	955 EUR
CIPR-GA70C4018BBAA-BAAAAA	Inverter GA700, 400 V, ND: 17,5 A / 7,5 kW, HD: 14,8 A / 5,5 kW, IP20	1.127 EUR
CIPR-GA70C4023BBAA-BAAAAA	Inverter GA700, 400 V, ND: 23,4 A / 11 kW, HD: 18 A / 7,5 kW, IP20	1.327 EUR
CIPR-GA70C4031BBAA-BAAAAA	Inverter GA700, 400 V, ND: 31 A / 15 kW, HD: 24 A / 11 kW, IP20	1.537 EUR
CIPR-GA70C4038BBAA-BAAAAA	Inverter GA700, 400 V, ND: 38 A / 18,5 kW, HD: 31 A / 15 kW, IP20	1.948 EUR
CIPR-GA70C4044BBAA-BAAAAA	Inverter GA700, 400 V, ND: 44 A / 22 kW, HD: 39 A / 18,5 kW, IP20	2.130 EUR
CIPR-GA70C4060BBAA-BAAAAA	Inverter GA700, 400 V, ND: 59,6 A / 30 kW, HD: 45 A / 22 kW, IP20	2.754 EUR
CIPR-GA70C4075BBAA-BAAAAA	Inverter GA700, 400 V, ND: 74,9 A / 37 kW, HD: 60 A / 30 kW, IP20	3.085 EUR
CIPR-GA70C4089BBAA-BAAAAA	Inverter GA700, 400 V, ND: 89,2 A / 45 kW, HD: 75 A / 37 kW, IP20	3.739 EUR
CIPR-GA70C4103BBAA-BAAAAA	Inverter GA700, 400 V, ND: 103 A / 55 kW, HD: 91 A / 45 kW, IP20	4.119 EUR
CIPR-GA70C4140BBAA-BAAAAA	Inverter GA700, 400 V, ND: 140 A / 75 kW, HD: 112 A / 55 kW, IP20	5.146 EUR
CIPR-GA70C4168BBAA-BAAAAA	Inverter GA700, 400 V, ND: 168 A / 90 kW, HD: 150 A / 75 kW, IP20	7.121 EUR
CIPR-GA70C4208BBAA-BAAAAA	Inverter GA700, 400 V, ND: 208 A / 110 kW, HD: 180 A / 90 kW, IP20	8.159 EUR
CIPR-GA70C4250BBAA-BAAAAA	Inverter GA700, 400 V, ND: 250 A / 132 kW, HD: 216 A / 110 kW, IP20	8.334 EUR
CIPR-GA70C4296BBAA-BAAAAA	Inverter GA700, 400 V, ND: 296 A / 160 kW, HD: 260 A / 132 kW, IP20	8.517 EUR
CIPR-GA70C4371BBAA-BAAAAA	Inverter GA700, 400 V, ND: 371 A / 185 kW, HD: 304 A / 160 kW, IP20	10.406 EUR
CIPR-GA70C4389BBAA-BAAAAA	Inverter GA700, 400 V, ND: 389 A / 220 kW, HD: 371 A / 200 kW, IP20	13.531 EUR
CIPR-GA70C4453BBAA-BAAAAA	Inverter GA700, 400 V, ND: 453 A / 250 kW, HD: 414 A / 220 kW, IP20	20.097 EUR
CIPR-GA70C4568BBAA-BAAAAA	Inverter GA700, 400 V, ND: 568 A / 315 kW, HD: 453 A / 250 kW, IP20	21.328 EUR
CIPR-GA70C4675BBAA-BAAAAA	Inverter GA700, 400 V, ND: 675 A / 355 kW, HD: 605 A / 315 kW, IP20	22.996 EUR

## Sinus Output-Filter IP00 for GA700 400VAC

Ürün Kodu	Açıklama	Liste Fiyatı
SR-40004A-00	Sinus Output Filter IP00 for GA70C4002. 04 Amp., 0,90 kg copper	127 EUR
SR-40006A-00	Sinus Output Filter IP00 for GA70C4004, 4005. 06 Amp., 1,10 kg copper	186 EUR
SR-40008A-00	Sinus Output Filter IP00 for GA70C4007. 08 Amp., 1,20 kg copper	208 EUR
SR-40010A-00	Sinus Output Filter IP00 for GA70C4009. 10 Amp., 1,90 kg copper	260 EUR
SR-40016A-00	Sinus Output Filter IP00 for GA70C4012. 16 Amp., 3,20 kg copper	337 EUR
SR-40020A-00	Sinus Output Filter IP00 for GA70C4018. 20 Amp., 3,30 kg copper	426 EUR
SR-40024A-00	Sinus Output Filter IP00 for GA70C4023. 24 Amp., 3,60 kg copper	503 EUR
SR-40037A-00	Sinus Output Filter IP00 for GA70C4031. 37 Amp., 9,90 kg copper	602 EUR
SR-40048A-00	Sinus Output Filter IP00 for GA70C4038, 4044. 48 Amp., 10,50 kg copper	683 EUR
SR-40060A-00	Sinus Output Filter IP00 for GA70C4060. 60 Amp., 11,50 kg copper	858 EUR
SR-40075A-00	Sinus Output Filter IP00 for GA70C4075. 75 Amp., 16,50 kg copper	953 EUR
SR-40115A-00	Sinus Output Filter IP00 for GA70C4089, 4103. 115 Amp., 2,0 kg copper	1.711 EUR
SR-40150A-00	Sinus Output Filter IP00 for GA70C4140. 150 Amp., 2,0 kg copper	1.736 EUR
SR-40200A-00	Sinus Output Filter IP00 for GA70C4168. 200 Amp., 2,0 kg copper	2.143 EUR
SR-40250A-00	Sinus Output Filter IP00 for GA70C4208, 4250. 250 Amp., 2,0 kg copper	2.639 EUR
SR-40350A-00	Sinus Output Filter IP00 for GA70C4296. 350 Amp., 3,0 kg copper	3.134 EUR
SR-40450A-00	Sinus Output Filter IP00 for GA70C4371, 4389, 4453. 450 Amp., 4,0 kg copper	3.289 EUR
SR-40600A-00	Sinus Output Filter IP00 for GA70C4568. 600 Amp., 5,0 kg copper	3.851 EUR
SR-40800A-00	Sinus Output Filter IP00 for GA70C4675. 800 Amp., 6,0 kg copper	8.529 EUR

Please note that we will add a copper fee to the above mentioned products on our order confirmation. The basis for the copper price which we will invoice is available on: <http://www.lme.com/copper.asp>. We use the following formula for the copper surcharge: ((3-month buyer\*exchange rate USD vs. EURO)/1000\*copper weight)

Limitation: for Carrier Frequency 2 kHz - 8 kHz

## IP20 Box for Sinus Output-Filter

Ürün Kodu	Açıklama	Liste Fiyatı
IP20-BOX06	IP20 Box for Sinus Output Filter SR-40004A-00 to SR-40010A-00	208 EUR
IP20-BOX07	IP20 Box for Sinus Output Filter SR-40016A-00 to SR-40024A-00	222 EUR
IP20-BOX08	IP20 Box for Sinus Output Filter SR-40037A-00 to SR-40060A-00	246 EUR
IP20-BOX03	IP20 Box for Sinus Output Filter SR-40075A-00 to SR-40250A-00	415 EUR
IP20-BOX04	IP20 Box for Sinus Output Filter SR-40350A-00 to SR-40600A-00	451 EUR
IP20-BOX05	IP20 Box for Sinus Output Filter SR-40800A-00 to SR-41200A-00	545 EUR

## AC Input Reactors 4 % IP00 for GA700 400VAC

Ürün Kodu	Açıklama	Liste Fiyatı
LR3 40-4/4	AC Input Reactor 4% IP00 for GA70C4002. 4 Amp., 0,30 kg copper	57 EUR
LR3 40-4/6	AC Input Reactor 4% IP00 for GA70C4004. 6 Amp., 0,31 kg copper	65 EUR
LR3 40-4/10	AC Input Reactor 4% IP00 for GA70C4005, 4007. 10 Amp., 0,60 kg copper	84 EUR
LR3 40-4/16	AC Input Reactor 4% IP00 for GA70C4009, 4012. 16 Amp., 0,67 kg copper	93 EUR
LR3 40-4/25	AC Input Reactor 4% IP00 for GA70C4018. 25 Amp., 1,52 kg copper	158 EUR
LR3 40-4/45	AC Input Reactor 4% IP00 for GA70C4023, 4031. 45 Amp., 2,35 kg copper	222 EUR
LR3 40-4/63	AC Input Reactor 4% IP00 for GA70C4038, 4044, 4060. 63 Amp., 2,71 kg copper	258 EUR
LR3 40-4/90	AC Input Reactor 4% IP00 for GA70C4075, 4089. 90 Amp., 5,50 kg copper	520 EUR
LR3 40-4/115	AC Input Reactor 4% IP00 for GA70C4103. 115 Amp., 5,80 kg copper	685 EUR
LR3 40-4/160	AC Input Reactor 4% IP00 for GA70C4140. 160 Amp., 8,85 kg copper	794 EUR
LR3 40-4/200	AC Input Reactor 4% IP00 for GA70C4168. 200 Amp., 11,0 kg copper	842 EUR
LR3 40-4/250	AC Input Reactor 4% IP00 for GA70C4208, 4250. 250 Amp., 14,5 kg copper	923 EUR
LR3 40-4/300	AC Input Reactor 4% IP00 for GA70C4296. 300 Amp., 16,2 kg copper	1.134 EUR
LR3 40-4/400	AC Input Reactor 4% IP00 for GA70C4371, 4389. 400 Amp., 18,0 kg copper	1.231 EUR
LR3 40-4/500	AC Input Reactor 4% IP00 for GA70C4453. 500 Amp., 21,0 kg copper	1.347 EUR
LR3 40-4/710	AC Input Reactor 4% IP00 for GA70C4568, 4675. 710 Amp., 36,4 kg copper	2.368 EUR

Please note that we will add a copper fee to the above mentioned products on our order confirmation. The basis for the copper price which we will invoice is available on: <http://www.lme.com/copper.asp>. We use the following formula for the copper surcharge: ((3-month buyer\*exchange rate USD vs. EURO)/1000\*copper weight)

## IP20 Box for AC Input Reactors 4 %

Ürün Kodu	Açıklama	Liste Fiyatı
IP20-BOX32	IP20 Box for AC input reactor type LR3 40-4/4 to LR3 40-4/20	60 EUR
IP20-BOX33	IP20 Box for AC input reactor type LR3 40-4/25	62 EUR
IP20-BOX35	IP20 Box for AC input reactor type LR3 40-4/45	70 EUR
IP20-BOX36	IP20 Box for AC input reactor type LR3 40-4/63	74 EUR
IP20-BOX37	IP20 Box for AC input reactor type LR3 40-4/70	81 EUR
IP20-BOX39	IP20 Box for AC input reactor type LR3 40-4/90	137 EUR
IP20-BOX41	IP20 Box for AC input reactor type LR3 40-4/115 to LR3 40-4/200	158 EUR
IP20-BOX44	IP20 Box for AC input reactor type LR3 40-4/250 to LR3 40-4/400	222 EUR
IP20-BOX45	IP20 Box for AC input reactor type LR3 40-4/500	238 EUR
IP20-BOX46	IP20 Box for AC input reactor type LR3 40-4/710 to LR3 40-4/1200	253 EUR

## AC Input Reactors IP00 2 % for GA700 400VAC

Ürün Kodu	Açıklama	Liste Fiyatı
ALR3 40-2/6	AC Input Reactor 2% IP00 for GA70C4002, 4004. 6 Amp., 0,25 kg copper	57 EUR
ALR3 40-2/10	AC Input Reactor 2% IP00 for GA70C4005, 4007. 10 Amp., 0,30 kg copper	69 EUR
ALR3 40-2/16	AC Input Reactor 2% IP00 for GA70C4009, 4012. 16 Amp., 0,50 kg copper	77 EUR
ALR3 40-2/25	AC Input Reactor 2% IP00 for GA70C4018. 25 Amp., 0,80 kg copper	88 EUR
ALR3 40-2/45	AC Input Reactor 2% IP00 for GA70C4023, 4031. 45 Amp., 1,40 kg copper	116 EUR
ALR3 40-2/63	AC Input Reactor 2% IP00 for GA70C4038, 4044, 4060. 63 Amp., 2,30 kg copper	194 EUR

Please note that we will add a copper fee to the above mentioned products on our order confirmation. The basis for the copper price which we will invoice is available on: <http://www.lme.com/copper.asp>. We use the following formula for the copper surcharge: ((3-month buyer\*exchange rate USD vs. EURO)/1000\*copper weight)

## IP20 Box for AC Input Reactors 2 %

Ürün Kodu	Açıklama	Liste Fiyatı
IP20-BOX31	IP20 Box for AC input reactor type ALR3 40-4/2 to ALR3 40-4/6	57 EUR
IP20-BOX32	IP20 Box for AC input reactor type ALR3 40-4/10 to ALR3 40-4/45	60 EUR
IP20-BOX35	IP20 Box for AC input reactor type ALR3 40-4/63	70 EUR

## AC Output Reactors IP00 for GA700 400VAC (up to 120 Hz Output Frequency)

Ürün Kodu	Açıklama	Liste Fiyatı
MDB 400/6,3	AC Output Reactor IP00 up to 120 Hz Output Frequency for GA70C4002, 4004, 4005. 6,3 Amp., 0,70 kg copper	204 EUR
MDB 400/13	AC Output Reactor IP00 up to 120 Hz Output Frequency for GA70C4007, 4009, 4012. 13 Amp., 0,90 kg copper	236 EUR
MDB 400/24	AC Output Reactor IP00 up to 120 Hz Output Frequency for GA70C4018, 4023 * 24 Amp., 1,30 kg copper	371 EUR
MDB 400/46	AC Output Reactor IP00 up to 120 Hz Output Frequency for GA70C4023 *, 4031, 4038, 4044. 46 Amp., 1,70 kg copper	452 EUR
MDB 400/72	AC Output Reactor IP00 up to 120 Hz Output Frequency for GA70C4060, 4075. 72 Amp., 1,30 kg copper	452 EUR
MDB 400/110	AC Output Reactor IP00 up to 120 Hz Output Frequency for GA70C4089, 4103. 110 Amp., 3,40 kg copper	699 EUR
MDB 400/176	AC Output Reactor IP00 up to 120 Hz Output Frequency for GA70C4140, 4168. 176 Amp., 7,60 kg copper	1.045 EUR
MDB 400/250	AC Output Reactor IP00 up to 120 Hz Output Frequency for GA70C4208, 4250. 250 Amp., 4,50 kg copper	1.061 EUR
MDB 400/380	AC Output Reactor IP00 up to 120 Hz Output Frequency for GA70C4296, 4371. 380 Amp., 9,5 kg copper	1.307 EUR
MDB 400/430	AC Output Reactor IP00 up to 120 Hz Output Frequency for GA70C4389. 430 Amp., 14,5 kg copper	1.782 EUR
MDB 400/700	AC Output Reactor IP00 up to 120 Hz Output Frequency for GA70C4453, 4568, 4675. 700 Amp., 42,0 kg copper	3.875 EUR

Please note that we will add a copper fee to the above mentioned products on our order confirmation. The basis for the copper price which we will invoice is

available on: <http://www.lme.com/copper.asp>. We use the following formula for the copper surcharge: ((3-month buyer\*exchange rate USD vs. EURO)/1000\*copper weight)

\* When you are using 8 kHz choose MDB 400/46.

## IP20 Box for AC Output Reactors IP00 (up to 120 Hz Output Frequency)

Ürün Kodu	Açıklama	Liste Fiyatı
IP20-BOX31	IP20 Box for AC Output Reactor MDB 400/6,3	57 EUR
IP20-BOX32	IP20 Box for AC Output Reactor MDB 400/13	60 EUR
IP20-BOX36	IP20 Box for AC Output Reactor MDB 400/24	74 EUR
IP20-BOX37	IP20 Box for AC Output Reactor MDB 400/46 to MDB 400/72	81 EUR
IP20-BOX39	IP20 Box for AC Output Reactor MDB 400/110	137 EUR
IP20-BOX41	IP20 Box for AC Output Reactor MDB 400/176 to MDB 400/380	158 EUR
IP20-BOX44	IP20 Box for AC Output Reactor MDB 400/430	222 EUR
IP20-BOX45	IP20 Box for AC Output Reactor MDB 400/700	238 EUR

## AC Output Reactors IP00 for GA700 400VAC (up to 50 Hz Output Frequency)

Ürün Kodu	Açıklama	Liste Fiyatı
MR3 400/4	AC Output Reactor IP00 up to 50 Hz Output Frequency for GA70C4002. 4 Amp., 0,10 kg copper	92 EUR
MR3 400/10	AC Output Reactor IP00 up to 50 Hz Output Frequency for GA70C4004, 4005, 4007, 4009. 10 Amp., 0,20 kg copper	117 EUR
MR3 400/18	AC Output Reactor IP00 up to 50 Hz Output Frequency for GA70C4012. 18 Amp., 0,40 kg copper	143 EUR
MR3 400/24	AC Output Reactor IP00 up to 50 Hz Output Frequency for GA70C4018, 4023 * 24 Amp., 0,50 kg copper	164 EUR
MR3 400/37	AC Output Reactor IP00 up to 50 Hz Output Frequency for GA70C4023 *, 37 Amp., 0,70 kg copper	207 EUR
MR3 400/48	AC Output Reactor IP00 up to 50 Hz Output Frequency for GA70C4031, 4038, 4044. 48 Amp., 1,10 kg copper	280 EUR
MR3 400/61	AC Output Reactor IP00 up to 50 Hz Output Frequency for GA70C4060. 61 Amp., 1,50 kg copper	387 EUR

Please note that we will add a copper fee to the above mentioned products on our order confirmation. The basis for the copper price which we will invoice is

available on: <http://www.lme.com/copper.asp>. We use the following formula for the copper surcharge: ((3-month buyer\*exchange rate USD vs. EURO)/1000\*copper weight)

\* When you are using 8 kHz choose MR3 400/37.

## IP20 Box for AC Output Reactors IP00 (up to 50 Hz Output Frequency)

Ürün Kodu	Açıklama	Liste Fiyatı
IP20-BOX31	IP20 Box for AC Output Reactor MR3 400/4	57 EUR
IP20-BOX32	IP20 Box for AC Output Reactor MR3 400/10 to MR3 400/24	60 EUR
IP20-BOX33	IP20 Box for AC Output Reactor MR3 400/37	62 EUR
IP20-BOX35	IP20 Box for AC Output Reactor MR3 400/48 to MR3 400/61	70 EUR

## Inverter GA700 200 VAC Three Phase - IP20

Ürün Kodu	Açıklama	Liste Fiyatı
GA70C2004BBA	Inverter GA700, 200 V, ND: 3,5 A / 0,75 kW, HD: 3,2 A / 0,55 kW, IP20	778 EUR
GA70C2006BBA	Inverter GA700, 200 V, ND: 6 A / 1,1 kW, HD: 5 A / 0,75 kW, IP20	880 EUR
GA70C2010BBA	Inverter GA700, 200 V, ND: 9,6 A / 2,2 kW, HD: 8 A / 1,5 kW, IP20	1.007 EUR
GA70C2012BBA	Inverter GA700, 200 V, ND: 12,2 A / 3 kW, HD: 11 A / 2,2 kW, IP20	1.102 EUR
GA70C2021BBA	Inverter GA700, 200 V, ND: 21 A / 5,5 kW, HD: 17,5 A / 3,7 kW, IP20	1.208 EUR
GA70C2030BBA	Inverter GA700, 200 V, ND: 30 A / 7,5 kW, HD: 25 A / 5,5 kW, IP20	1.515 EUR
GA70C2042BBA	Inverter GA700, 200 V, ND: 42 A / 11 kW, HD: 33 A / 7,5 kW, IP20	1.773 EUR
GA70C2056BBA	Inverter GA700, 200 V, ND: 56 A / 15 kW, HD: 47 A / 11 kW, IP20	2.255 EUR
GA70C2070BBA	Inverter GA700, 200 V, ND: 70 A / 18,5 kW, HD: 60 A / 15 kW, IP20	3.161 EUR
GA70C2082BBA	Inverter GA700, 200 V, ND: 82 A / 22 kW, HD: 75 A / 18,5 kW, IP20	4.649 EUR
GA70C2110BBA	Inverter GA700, 200 V, ND: 110 A / 30 kW, HD: 88 A / 22 kW, IP20	5.112 EUR
GA70C2138BBA	Inverter GA700, 200 V, ND: 138 A / 37 kW, HD: 115 A / 30 kW, IP20	5.441 EUR
GA70C2169BBA	Inverter GA700, 200 V, ND: 169 A / 45 kW, HD: 145 A / 37 kW, IP20	6.674 EUR
GA70C2211BBA	Inverter GA700, 200 V, ND: 211 A / 55 kW, HD: 180 A / 45 kW, IP20	7.364 EUR
GA70C2257BBA	Inverter GA700, 200 V, ND: 257 A / 75 kW, HD: 215 A / 55 kW, IP20	8.783 EUR
GA70C2313BBA	Inverter GA700, 200 V, ND: 313 A / 90 kW, HD: 283 A / 75 kW, IP20	15.866 EUR
GA70C2360BBA	Inverter GA700, 200 V, ND: 360 A / 110 kW, HD: 346 A / 90 kW, IP20	17.796 EUR
GA70C2415BBA	Inverter GA700, 200 V, HD: 415 A / 110 kW, IP20	19.898 EUR

## Options for GA700 Series

Ürün Kodu	Açıklama	Liste Fiyatı
900-192-121-001	NEMA Type 1 Kit GA70x2004~2042 and 4002~4023	91 EUR
900-192-121-002	NEMA Type 1 Kit GA70x2056 and 4031~4038	95 EUR
900-195-896-001	Shield Clamp Kit GA70x2004~2042 and 4002~4023	151 EUR
900-195-896-002	Shield Clamp Kit GA70x2056 and 4031~4038	165 EUR
900-193-209-001	Heatsink External Mounting Kit GA70x2004~2042 and 4002~4023	28 EUR
900-193-209-002	Heatsink External Mounting Kit GA70x2056 and 4031~4038	31 EUR
900-193-209-003	Heatsink External Mounting Kit GA70x2070 and 4044~4060	31 EUR
900-192-933-001	Door mounting kit for keypad JVOP-KPLxxxxxx, screw mounting	31 EUR
900-192-933-002	Door mounting kit for keypad JVOP-KPLxxxxxx, stud mounting	31 EUR
JVOP-KPLEA04AAA	LED Keypad JVOP-KPLEA04AAA	64 EUR
JVOP-KPLCC04AAA	LCD Keypad with integrated Bluetooth module, JVOP-KPLCC04AAA	256 EUR
AI-A3	Analog Input card (3 inputs)	179 EUR
AO-A3	2 additional Analog Output	133 EUR
CDBR-2022D	200V Braking Transistor Unit 22kW	561 EUR
CDBR-2037D	200V Braking Transistor Unit 37kW	843 EUR
CDBR-2055D	200V Braking Transistor Unit 45kW	1.715 EUR
CDBR-2110D	200V Braking Transistor Unit 110kW	1.968 EUR
CDBR-4045D	400V Braking Transistor Unit 45kW	575 EUR
CDBR-4090D	400V Braking Transistor Unit 90kW	1.803 EUR
CDBR-4220D	400V Braking Transistor Unit 220kW	2.302 EUR
DI-A3	Digital Input (BCD Code)	109 EUR
DO-A3	Digital Output (6 open collector 2 relais)	109 EUR
JZSP-CVS06-02-E	USB connection cable for PC 2.5m	113 EUR
MANUAL	Technical Manual - Printed Version - for GA700 Series	64 EUR
PG-B3	Open Collector PG-Interface Card 50kHz	104 EUR
PG-X3	Line Driver PG-Interface Card 300kHz	104 EUR
PG-RT3	TS2640N321E64 PG-Interface Card	355 EUR
SI-C3	Comm. Interface GA700 CCLink	259 EUR
SI-EL3	Comm. Interface GA700 Powerlink	558 EUR
SI-EN3	Comm. Interface GA700 EtherNet IP	333 EUR
SI-EN3D	Comm. Interface GA700 Dual Port EtherNet IP	455 EUR
SI-EM3	Comm. Interface GA700 Modbus TCP	356 EUR
SI-EM3D	Comm. Interface GA700 Dual Port Modbus TCP	534 EUR
SI-EP3	Comm. Interface GA700 ProfiNet	498 EUR
SI-ES3	Comm. Interface GA700 EtherCAT	357 EUR
SI-N3	Comm. Interface GA700 DeviceNET	169 EUR
SI-P3	Comm. Interface GA700 ProfibusDP	361 EUR
SI-S3	Comm. Interface GA700 CANopen	187 EUR
SI-T3	Comm. Interface GA700 Mechatrolink II	242 EUR
SI-ET3	Comm. Interface GA700 Mechatrolink III	291 EUR
WV001-YEG	1m extension cable for remote Digital Operator	51 EUR



WV003-YEG	3m extension cable for remote Digital Operator	60 EUR
-----------	--	--------



## J 1000 Inverter

- @ 0,1 - 5,5kW
- @ 200VAC & 400VAC
- @ 5 dig. Input / 1 analog Input
- @ 1 analog Output / 1 Relay output
- @ V/f control

### Inverter J1000 400 VAC Three Phase - IP20

Ürün Kodu	Açıklama	Liste Fiyatı
CIMR-JC4A0001BAA	Inverter J1000, 400 V, ND: 1,2 A / 0,4 kW, HD: 1,2 A / 0,2 kW, IP20	303 EUR
CIMR-JC4A0002BAA	Inverter J1000, 400 V, ND: 2,1 A / 0,75 kW, HD: 1,8 A / 0,4 kW, IP20	334 EUR
CIMR-JC4A0004BAA	Inverter J1000, 400 V, ND: 4,1 A / 1,5 kW, HD: 3,4 A / 0,75 kW, IP20	378 EUR
CIMR-JC4A0005BAA	Inverter J1000, 400 V, ND: 5,4 A / 2,2 kW, HD: 4,8 A / 1,5 kW, IP20	423 EUR
CIMR-JC4A0007BAA	Inverter J1000, 400 V, ND: 6,9 A / 3 kW, HD: 5,5 A / 2,2 kW, IP20	508 EUR
CIMR-JC4A0009BAA	Inverter J1000, 400 V, ND: 8,8 A / 3,7 kW, HD: 7,2 A / 3 kW, IP20	557 EUR
CIMR-JC4A0011BAA	Inverter J1000, 400 V, ND: 11,1 A / 5,5 kW, HD: 9,2 A / 4 kW, IP20	619 EUR

### Inverter J1000 400 VAC Three Phase - Cold Plate

Ürün Kodu	Açıklama	Liste Fiyatı
CIMR-JC4A0001JAB	Inverter J1000, 400 V, ND: 1,2 A / 0,4 kW, HD: 1,2 A / 0,2 kW, Cold Plate	393 EUR
CIMR-JC4A0002JAB	Inverter J1000, 400 V, ND: 2,1 A / 0,75 kW, HD: 1,8 A / 0,4 kW, Cold Plate	432 EUR
CIMR-JC4A0004JAB	Inverter J1000, 400 V, ND: 4,1 A / 1,5 kW, HD: 3,4 A / 0,75 kW, Cold Plate	481 EUR
CIMR-JC4A0005JAB	Inverter J1000, 400 V, ND: 5,4 A / 2,2 kW, HD: 4,8 A / 1,5 kW, Cold Plate	530 EUR
CIMR-JC4A0007JAB	Inverter J1000, 400 V, ND: 6,9 A / 3 kW, HD: 5,5 A / 2,2 kW, Cold Plate	625 EUR
CIMR-JC4A0009JAB	Inverter J1000, 400 V, ND: 8,8 A / 3,7 kW, HD: 7,2 A / 3 kW, Cold Plate	681 EUR
CIMR-JC4A0011JAB	Inverter J1000, 400 V, ND: 11,1 A / 5,5 kW, HD: 9,2 A / 4 kW, Cold Plate	747 EUR

### EMC Line-Filters for J1000 400VAC

Ürün Kodu	Açıklama	Liste Fiyatı
FS23639-5-07	EMC Line-Filter for CIMR-JC4A0001, 0002, 0004. EN61800-3 Class C1, 07 Amp.	58 EUR
FS23639-10-07	EMC Line-Filter for CIMR-JC4A0005, 0007, 0009. EN61800-3 Class C1, 10 Amp.	73 EUR
FS23639-15-07	EMC Line-Filter for CIMR-JC4A0011. EN61800-3 Class C1, 15 Amp.	92 EUR

All filters are footmount

### Inverter J1000 200 VAC Single Phase - IP20

Ürün Kodu	Açıklama	Liste Fiyatı
CIMR-JCBA0002BAA	Inverter J1000, 200 V, ND: 1,9 A / 0,4 kW, HD: 1,6 A / 0,2 kW, IP20	168 EUR
CIMR-JCBA0003BAA	Inverter J1000, 200 V, ND: 3,5 A / 0,75 kW, HD: 3 A / 0,4 kW, IP20	190 EUR
CIMR-JCBA0006BAA	Inverter J1000, 200 V, ND: 6 A / 1,1 kW, HD: 5 A / 0,75 kW, IP20	225 EUR
CIMR-JCBA0010BAA	Inverter J1000, 200 V, ND: 9,6 A / 2,2 kW, HD: 8 A / 1,5 kW, IP20	299 EUR

### Inverter J1000 200 VAC Single Phase IP20 - Cold Plate

Ürün Kodu	Açıklama	Liste Fiyatı
CIMR-JCBA0002JAB	Inverter J1000, 200 V, ND: 1,9 A / 0,4 kW, HD: 1,6 A / 0,2 kW, Cold Plate	241 EUR
CIMR-JCBA0003JAB	Inverter J1000, 200 V, ND: 3,5 A / 0,75 kW, HD: 3 A / 0,4 kW, Cold Plate	265 EUR
CIMR-JCBA0006JAB	Inverter J1000, 200 V, ND: 6 A / 1,1 kW, HD: 5 A / 0,75 kW, Cold Plate	305 EUR
CIMR-JCBA0010JAB	Inverter J1000, 200 V, ND: 9,6 A / 2,2 kW, HD: 8 A / 1,5 kW, Cold Plate	392 EUR

## EMC Line-Filters for J1000 200VAC Single Phase

Ürün Kodu	Açıklama	Liste Fiyatı
FS23638-10-07	EMC Line-Filter for CIMR-JCBA0001, 0002, 0003. EN61800-3 Class C1, 10 Amp.	32 EUR
FS23638-20-07	EMC Line-Filter for CIMR-JCBA0006, 0010. EN61800-3 Class C1, 20 Amp.	49 EUR

All filters are footmount

## Inverter J1000 200 VAC Three Phase - IP20

Ürün Kodu	Açıklama	Liste Fiyatı
CIMR-JC2A0001BAA	Inverter J1000, 200 V, ND: 1,2 A / 0,2 kW, HD: 0,8 A / 0,1 kW, IP20	205 EUR
CIMR-JC2A0002BAA	Inverter J1000, 200 V, ND: 1,9 A / 0,4 kW, HD: 1,6 A / 0,2 kW, IP20	212 EUR
CIMR-JC2A0004BAA	Inverter J1000, 200 V, ND: 3,5 A / 0,75 kW, HD: 3 A / 0,4 kW, IP20	202 EUR
CIMR-JC2A0006BAA	Inverter J1000, 200 V, ND: 6 A / 1,1 kW, HD: 5 A / 0,75 kW, IP20	229 EUR
CIMR-JC2A0010BAA	Inverter J1000, 200 V, ND: 9,6 A / 2,2 kW, HD: 8 A / 1,5 kW, IP20	274 EUR
CIMR-JC2A0012BAA	Inverter J1000, 200 V, ND: 12 A / 3 kW, HD: 11 A / 2,2 kW, IP20	336 EUR
CIMR-JC2A0020BAA	Inverter J1000, 200 V, ND: 19,6 A / 5,5 kW, HD: 17,5 A / 4 kW, IP20	594 EUR

## Inverter J1000 200 VAC Three Phase IP20 - Cold Plate

Ürün Kodu	Açıklama	Liste Fiyatı
CIMR-JC2A0001JAB	Inverter J1000, 200 V, ND: 1,2 A / 0,2 kW, HD: 0,8 A / 0,1 kW, Cold Plate	277 EUR
CIMR-JC2A0002JAB	Inverter J1000, 200 V, ND: 1,9 A / 0,4 kW, HD: 1,6 A / 0,2 kW, Cold Plate	280 EUR
CIMR-JC2A0004JAB	Inverter J1000, 200 V, ND: 3,5 A / 0,75 kW, HD: 3 A / 0,4 kW, Cold Plate	270 EUR
CIMR-JC2A0006JAB	Inverter J1000, 200 V, ND: 6 A / 1,1 kW, HD: 5 A / 0,75 kW, Cold Plate	298 EUR
CIMR-JC2A0010JAB	Inverter J1000, 200 V, ND: 9,6 A / 2,2 kW, HD: 8 A / 1,5 kW, Cold Plate	348 EUR
CIMR-JC2A0012JAB	Inverter J1000, 200 V, ND: 12 A / 3 kW, HD: 11 A / 2,2 kW, Cold Plate	417 EUR
CIMR-JC2A0020JAB	Inverter J1000, 200 V, ND: 19,6 A / 5,5 kW, HD: 17,5 A / 4 kW, Cold Plate	684 EUR

## EMC Line-Filters for J1000 200VAC Three Phase

Ürün Kodu	Açıklama	Liste Fiyatı
FS23637-8-07	EMC Line-Filter for CIMR-JC2A0001, 0002, 0004, 0006. EN61800-3 Class C1, 10 Amp.	85 EUR
FS23637-14-07	EMC Line-Filter for CIMR-JC2A0010, 0012. EN61800-3 Class C1, 10 Amp.	104 EUR
FS23637-24-07	EMC Line-Filter for CIMR-JC2A0020. EN61800-3 Class C1, 10 Amp.	129 EUR

All filters are footmount

## Options for J1000 Series

Ürün Kodu	Açıklama	Liste Fiyatı
AI-V3/J	Potentiometer	45 EUR
EZZ08122A	DIN Rail Attachment J1000 230V 2A, 3A / 200V 1A, 2A, 4A, 6A	14 EUR
EZZ08122B	DIN Rail Attachment J1000 230V 6A, 10A, / 200V 10A, 12A / 400V 1A, 2A, 4A, 5A, 7A, 9A	14 EUR
EZZ08122C	DIN Rail Attachment J1000 200V 20A / 400V 11A	14 EUR
JVOP-181	Copy unit w/USB converter *	232 EUR
JVOP-182	LED operator Panel *	63 EUR
MANUAL	Technical Manual - Printed Version - for J1000 Series	64 EUR
SI-232/J	Ser. Comm. Interf. RS 232-C for LED Operator JVOP-182	56 EUR
SI-232/JC	Ser. Comm. Interf. RS 232-C for PC or Copy Unit JVOP-181	70 EUR
SI-485/J	Ser. Comm. Interf. RS 485 (Memobus / Modbus) for J1000	63 EUR
WV001-YEG	1m extension cable for remote Digital Operator	51 EUR
WV003-YEG	3m extension cable for remote Digital Operator	60 EUR

\* Requires SI-232/J or SI-232/JC



## V 1000 Inverter

- @ 0,1 - 15kW
- @ 200VAC & 400VAC
- @ 6 dig. Input / 1 Pulse Input / 2 analog Input / 2 Safety Inputs
- @ 1 Pulse Output / 1 Analog Output / 1 Relay output / 2 Photocoupler Output
- @ V/f / Open Loop Vector for IM (Vector for PM)

### Inverter V1000 400 VAC Three Phase - IP20 / NEMA1

Ürün Kodu	Açıklama	Liste Fiyatı
CIMR-VC4A0001BAA	Inverter V1000, 400 V, ND: 1,2 A / 0,4 kW, HD: 1,2 A / 0,2 kW, IP20	362 EUR
CIMR-VC4A0002BAA	Inverter V1000, 400 V, ND: 2,1 A / 0,75 kW, HD: 1,8 A / 0,4 kW, IP20	388 EUR
CIMR-VC4A0004BAA	Inverter V1000, 400 V, ND: 4,1 A / 1,5 kW, HD: 3,4 A / 0,75 kW, IP20	450 EUR
CIMR-VC4A0005BAA	Inverter V1000, 400 V, ND: 5,4 A / 2,2 kW, HD: 4,8 A / 1,5 kW, IP20	484 EUR
CIMR-VC4A0007BAA	Inverter V1000, 400 V, ND: 6,9 A / 3 kW, HD: 5,5 A / 2,2 kW, IP20	518 EUR
CIMR-VC4A0009BAA	Inverter V1000, 400 V, ND: 8,8 A / 3,7 kW, HD: 7,2 A / 3 kW, IP20	626 EUR
CIMR-VC4A0011BAA	Inverter V1000, 400 V, ND: 11,1 A / 5,5 kW, HD: 9,2 A / 4 kW, IP20	686 EUR
CIMR-VC4A0018FAA	Inverter V1000, 400 V, ND: 17,5 A / 7,5 kW, HD: 14,8 A / 5,5 kW, NEMA 1	816 EUR
CIMR-VC4A0023FAA	Inverter V1000, 400 V, ND: 23 A / 11 kW, HD: 18 A / 7,5 kW, NEMA 1	900 EUR
CIMR-VC4A0031FAA	Inverter V1000, 400 V, ND: 31 A / 15 kW, HD: 24 A / 11 kW, NEMA 1	1.171 EUR
CIMR-VC4A0038FAA	Inverter V1000, 400 V, ND: 38 A / 18,5 kW, HD: 31 A / 15 kW, NEMA 1	1.524 EUR

### Inverter V1000 400 VAC Three Phase - Cold Plate

Ürün Kodu	Açıklama	Liste Fiyatı
CIMR-VC4A0001JAB	Inverter V1000, 400 V, ND: 1,2 A / 0,4 kW, HD: 1,2 A / 0,2 kW, Cold Plate	448 EUR
CIMR-VC4A0002JAB	Inverter V1000, 400 V, ND: 2,1 A / 0,75 kW, HD: 1,8 A / 0,4 kW, Cold Plate	479 EUR
CIMR-VC4A0004JAB	Inverter V1000, 400 V, ND: 4,1 A / 1,5 kW, HD: 3,4 A / 0,75 kW, Cold Plate	552 EUR
CIMR-VC4A0005JAB	Inverter V1000, 400 V, ND: 5,4 A / 2,2 kW, HD: 4,8 A / 1,5 kW, Cold Plate	590 EUR
CIMR-VC4A0007JAB	Inverter V1000, 400 V, ND: 6,9 A / 3 kW, HD: 5,5 A / 2,2 kW, Cold Plate	641 EUR
CIMR-VC4A0009JAB	Inverter V1000, 400 V, ND: 8,8 A / 3,7 kW, HD: 7,2 A / 3 kW, Cold Plate	769 EUR
CIMR-VC4A0011JAB	Inverter V1000, 400 V, ND: 11,1 A / 5,5 kW, HD: 9,2 A / 4 kW, Cold Plate	845 EUR
CIMR-VC4A0018JAB	Inverter V1000, 400 V, ND: 17,5 A / 7,5 kW, HD: 14,8 A / 5,5 kW, Cold Plate	989 EUR
CIMR-VC4A0023JAB	Inverter V1000, 400 V, ND: 23 A / 11 kW, HD: 18 A / 7,5 kW, Cold Plate	1.116 EUR
CIMR-VC4A0031JAB	Inverter V1000, 400 V, ND: 31 A / 15 kW, HD: 24 A / 11 kW, Cold Plate	1.630 EUR
CIMR-VC4A0038JAB	Inverter V1000, 400 V, ND: 38 A / 18,5 kW, HD: 31 A / 15 kW, Cold Plate	2.019 EUR

### Inverter V1000 400 VAC Three Phase - IP66

Ürün Kodu	Açıklama	Liste Fiyatı
CIMR-VC4A0001HAA-0080	Inverter V1000, 400 V, ND: 1,2 A / 0,4 kW, HD: 1,2 A / 0,2 kW, IP66 with Digital Operator	847 EUR
CIMR-VC4A0002HAA-0080	Inverter V1000, 400 V, ND: 2,1 A / 0,75 kW, HD: 1,8 A / 0,4 kW, IP66 with Digital Operator	887 EUR
CIMR-VC4A0004HAA-0080	Inverter V1000, 400 V, ND: 4,1 A / 1,5 kW, HD: 3,4 A / 0,75 kW, IP66 with Digital Operator	965 EUR
CIMR-VC4A0005HAA-0080	Inverter V1000, 400 V, ND: 5,4 A / 2,2 kW, HD: 4,8 A / 1,5 kW, IP66 with Digital Operator	1.109 EUR
CIMR-VC4A0007HAA-0080	Inverter V1000, 400 V, ND: 6,9 A / 3 kW, HD: 5,5 A / 2,2 kW, IP66 with Digital Operator	1.143 EUR
CIMR-VC4A0009HAA-0080	Inverter V1000, 400 V, ND: 8,8 A / 3,7 kW, HD: 7,2 A / 3 kW, IP66 with Digital Operator	1.224 EUR
CIMR-VC4A0011HAA-0080	Inverter V1000, 400 V, ND: 11,1 A / 5,5 kW, HD: 9,2 A / 4 kW, IP66 with Digital Operator	1.341 EUR
CIMR-VC4A0018HAA-0080	Inverter V1000, 400 V, ND: 17,1 A / 7,5 kW, HD: 14,8 A / 5,5 kW, IP66 with Digital Operator	2.568 EUR
CIMR-VC4A0023HAA-0080	Inverter V1000, 400 V, ND: 23 A / 11 kW, HD: 18 A / 7,5 kW, IP66 with Digital Operator	2.590 EUR
CIMR-VC4A0031HAA-0080	Inverter V1000, 400 V, ND: 31 A / 15 kW, HD: 24 A / 11 kW, IP66 with Digital Operator	2.755 EUR
CIMR-VC4A0038HAA-0080	Inverter V1000, 400 V, ND: 38 A / 18,5 kW, HD: 31 A / 15 kW, IP66 with Digital Operator	3.062 EUR
CIMR-VC4A0001HAA-0081	Inverter V1000, 400 V, ND: 1,2 A / 0,4 kW, HD: 1,2 A / 0,2 kW, IP66 with RJ45	818 EUR

CIMR-VC4A0002HAA-0081	Inverter V1000, 400 V, ND: 2,1 A / 0,75 kW, HD: 1,8 A / 0,4 kW, IP66 with RJ45	862 EUR
CIMR-VC4A0004HAA-0081	Inverter V1000, 400 V, ND: 4,1 A / 1,5 kW, HD: 3,4 A / 0,75 kW, IP66 with RJ45	936 EUR
CIMR-VC4A0005HAA-0081	Inverter V1000, 400 V, ND: 5,4 A / 2,2 kW, HD: 4,8 A / 1,5 kW, IP66 with RJ45	1.080 EUR
CIMR-VC4A0007HAA-0081	Inverter V1000, 400 V, ND: 6,9 A / 3 kW, HD: 5,5 A / 2,2 kW, IP66 with RJ45	1.116 EUR
CIMR-VC4A0009HAA-0081	Inverter V1000, 400 V, ND: 8,8 A / 3,7 kW, HD: 7,2 A / 3 kW, IP66 with RJ45	1.197 EUR
CIMR-VC4A0011HAA-0081	Inverter V1000, 400 V, ND: 11,1 A / 5,5 kW, HD: 9,2 A / 4 kW, IP66 with RJ45	1.312 EUR
CIMR-VC4A0018HAA-0081	Inverter V1000, 400 V, ND: 17,1 A / 7,5 kW, HD: 14,8 A / 5,5 kW, IP66 with RJ45	2.537 EUR
CIMR-VC4A0023HAA-0081	Inverter V1000, 400 V, ND: 23 A / 11 kW, HD: 18 A / 7,5 kW, IP66 with RJ45	2.564 EUR
CIMR-VC4A0031HAA-0081	Inverter V1000, 400 V, ND: 31 A / 15 kW, HD: 24 A / 11 kW, IP66 with RJ45	2.727 EUR
CIMR-VC4A0038HAA-0081	Inverter V1000, 400 V, ND: 38 A / 18,5 kW, HD: 31 A / 15 kW, IP66 with RJ45	3.036 EUR

Internal filter (C1, 10m) supplied no additional filter required.

#### Inverter V1000 400 VAC Three Phase - IP20 / NEMA1 with 1000 Hz Software

Ürün Kodu	Açıklama	Liste Fiyatı
CIMR-VC4B0001BAA	Inverter V1000, 400 V, HD: 1,2 A / 0,2 kW, IP20 & 1000 Hz Software	473 EUR
CIMR-VC4B0002BAA	Inverter V1000, 400 V, HD: 1,8 A / 0,4 kW, IP20 & 1000 Hz Software	480 EUR
CIMR-VC4B0004BAA	Inverter V1000, 400 V, HD: 3,4 A / 0,75 kW, IP20 & 1000 Hz Software	508 EUR
CIMR-VC4B0005BAA	Inverter V1000, 400 V, HD: 4,8 A / 1,5 kW, IP20 & 1000 Hz Software	551 EUR
CIMR-VC4B0007BAA	Inverter V1000, 400 V, HD: 5,5 A / 2,2 kW, IP20 & 1000 Hz Software	551 EUR
CIMR-VC4B0009BAA	Inverter V1000, 400 V, HD: 7,2 A / 3 kW, IP20 & 1000 Hz Software	573 EUR
CIMR-VC4B0011BAA	Inverter V1000, 400 V, HD: 9,2 A / 4 kW, IP20 & 1000 Hz Software	628 EUR
CIMR-VC4B0018FAA	Inverter V1000, 400 V, HD: 14,8 A / 5,5 kW, NEMA1 & 1000 Hz Software	878 EUR
CIMR-VC4B0023FAA	Inverter V1000, 400 V, HD: 18 A / 7,5 kW, NEMA1 & 1000 Hz Software	967 EUR
CIMR-VC4B0031FAA	Inverter V1000, 400 V, HD: 24 A / 11 kW, NEMA1 & 1000 Hz Software	1.310 EUR
CIMR-VC4B0038FAA	Inverter V1000, 400 V, HD: 31 A / 15 kW, NEMA1 & 1000 Hz Software	1.621 EUR

#### EMC Line-Filters for V1000 400 VAC

Ürün Kodu	Açıklama	Liste Fiyatı
FS23639-5-07	EMC Line-Filter for CIMR-VC4A0001, 0002, 0004. EN61800-3 Class C1, 05 Amp.	58 EUR
FS23639-10-07	EMC Line-Filter for CIMR-VC4A0005, 0007, 0009. EN61800-3 Class C1, 10 Amp.	73 EUR
FS23639-15-07	EMC Line-Filter for CIMR-VC4A0011. EN61800-3 Class C1, 15 Amp.	92 EUR
FS23639-30-07	EMC Line-Filter for CIMR-VC4A0018, 0023. EN61800-3 Class C1, 30 Amp.	101 EUR
FS23639-50-07	EMC Line-Filter for CIMR-VC4A0031, 00038. EN61800-3 Class C1, 50 Amp.	186 EUR

All filters are footmount

#### Sinus Output-Filter IP00 for V1000 400 VAC

Ürün Kodu	Açıklama	Liste Fiyatı
SR-40004A-00	Sinus Output Filter IP00 for CIMR-VC4A0002. 04 Amp., 0,90 kg copper	127 EUR
SR-40006A-00	Sinus Output Filter IP00 for CIMR-VC4A0004, 0005. 06 Amp., 1,10 kg copper	186 EUR
SR-40008A-00	Sinus Output Filter IP00 for CIMR-VC4A0007. 08 Amp., 1,20 kg copper	208 EUR
SR-40010A-00	Sinus Output Filter IP00 for CIMR-VC4A0009. 10 Amp., 1,90 kg copper	260 EUR
SR-40016A-00	Sinus Output Filter IP00 for CIMR-VC4A0011. 16 Amp., 3,20 kg copper	337 EUR
SR-40020A-00	Sinus Output Filter IP00 for CIMR-VC4A0018. 20 Amp., 3,30 kg copper	426 EUR
SR-40024A-00	Sinus Output Filter IP00 for CIMR-VC4A0023. 24 Amp., 3,60 kg copper	503 EUR
SR-40037A-00	Sinus Output Filter IP00 for CIMR-VC4A0031. 37 Amp., 9,90 kg copper	602 EUR
SR-40048A-00	Sinus Output Filter IP00 for CIMR-VC4A0038. 48 Amp., 10,50 kg copper	683 EUR

Please note that we will add a copper fee to the above mentioned products on our order confirmation. The basis for the copper price which we will invoice is available on: <http://www.lme.com/copper.asp>. We use the following formular for the copper surcharge: ((3-month buyer\*exchange rate USD vs. EURO)/1000\*copper weight)

Limitation: for Carrier Frequency 2 kHz - 8 kHz

#### IP20 Box for Sinus Output-Filter

Ürün Kodu	Açıklama	Liste Fiyatı
IP20-BOX06	IP20 Box for Sinus Output Filter SR-40004A-00 to SR-40010A-00	208 EUR
IP20-BOX07	IP20 Box for Sinus Output Filter SR-40016A-00 to SR-40024A-00	222 EUR
IP20-BOX08	IP20 Box for Sinus Output Filter SR-40037A-00 to SR-40048A-00	246 EUR

## dV/dt Output-Filter IP00 for V1000 400 VAC

Ürün Kodu	Açıklama	Liste Fiyatı
DB-40007A-IP00	For inverter models CIMR-VC4A0001, 0002, 0004, 0005, 0007. 07 Amp., 0,50 kg copper	274 EUR
DB-40024A-IP00	For inverter models CIMR-VC4A0009, 0011, 0018, 0023. 24 Amp., 1,60 kg copper	396 EUR
DB-40045A-IP00	For inverter models CIMR-VC4A0031, 0038. 45 Amp., 3,30 kg copper	611 EUR

Please note that we will add a copper fee to the above mentioned products on our order confirmation. The basis for the copper price which we will invoice is available on: <http://www.lme.com/copper.asp>. We use the following formula for the copper surcharge: ((3-month buyer\*exchange rate USD vs. EURO)/1000\*copper weight)

## IP20 Box for dV/dt Output-Filter

Ürün Kodu	Açıklama	Liste Fiyatı
IP20-BOX31	IP20 Box for dV/dt Output Filter DB-40007A-IP00	57 EUR
IP20-BOX32	IP20 Box for dV/dt Output Filter DB-40024A-IP00	60 EUR
IP20-BOX35	IP20 Box for dV/dt Output Filter DB-40045A-IP00	70 EUR

## AC Input Reactors 4 % IP00 for V1000 400VAC

Ürün Kodu	Açıklama	Liste Fiyatı
LR3 40-4/2	AC Input Reactor 4% IP00 for CIMR-VC4A0001, 0002. 02 Amp., 0,12 kg copper	52 EUR
LR3 40-4/4	AC Input Reactor 4% IP00 for CIMR-VC4A0004. 04 Amp., 0,30 kg copper	57 EUR
LR3 40-4/6	AC Input Reactor 4% IP00 for CIMR-VC4A0005. 06 Amp., 0,31 kg copper	65 EUR
LR3 40-4/10	AC Input Reactor 4% IP00 for CIMR-VC4A0007, 0009. 10 Amp., 0,60 kg copper	84 EUR
LR3 40-4/16	AC Input Reactor 4% IP00 for CIMR-VC4A0011. 16 Amp., 0,67 kg copper	93 EUR
LR3 40-4/20	AC Input Reactor 4% IP00 for CIMR-VC4A0018. 20 Amp., 1,20 kg copper	113 EUR
LR3 40-4/25	AC Input Reactor 4% IP00 for CIMR-VC4A0023. 25 Amp., 1,52 kg copper	158 EUR
LR3 40-4/45	AC Input Reactor 4% IP00 for CIMR-VC4A0031, 0038. 45 Amp., 2,35 kg copper	222 EUR

Please note that we will add a copper fee to the above mentioned products on our order confirmation. The basis for the copper price which we will invoice is available on: <http://www.lme.com/copper.asp>. We use the following formula for the copper surcharge: ((3-month buyer\*exchange rate USD vs. EURO)/1000\*copper weight)

## IP20 Box for AC Input Reactors 4 %

Ürün Kodu	Açıklama	Liste Fiyatı
IP20-BOX31	IP20 Box for AC input reactor type LR3 40-4/2	57 EUR
IP20-BOX32	IP20 Box for AC input reactor type LR3 40-4/4 to LR3 40-4/20	60 EUR
IP20-BOX33	IP20 Box for AC input reactor type LR3 40-4/25	62 EUR
IP20-BOX35	IP20 Box for AC input reactor type LR3 40-4/45	70 EUR

## AC Input Reactors 2 % IP00 for V1000 400VAC

Ürün Kodu	Açıklama	Liste Fiyatı
ALR3 40-2/2	AC Input Reactor 2% IP00 for CIMR-VC4A0001, 0002. 02 Amp., 0,10 kg copper	53 EUR
ALR3 40-2/4	AC Input Reactor 2% IP00 for CIMR-VC4A0004. 04 Amp., 0,15 kg copper	53 EUR
ALR3 40-2/6	AC Input Reactor 2% IP00 for CIMR-VC4A0005. 06 Amp., 0,25 kg copper	57 EUR
ALR3 40-2/10	AC Input Reactor 2% IP00 for CIMR-VC4A0007, 0009. 10 Amp., 0,30 kg copper	69 EUR
ALR3 40-2/16	AC Input Reactor 2% IP00 for CIMR-VC4A0011. 16 Amp., 0,50 kg copper	77 EUR
ALR3 40-2/20	AC Input Reactor 2% IP00 for CIMR-VC4A0018. 20 Amp., 0,60 kg copper	77 EUR
ALR3 40-2/25	AC Input Reactor 2% IP00 for CIMR-VC4A0023. 25 Amp., 0,80 kg copper	88 EUR
ALR3 40-2/45	AC Input Reactor 2% IP00 for CIMR-VC4A0031, 0038. 45 Amp., 1,40 kg copper	116 EUR

Please note that we will add a copper fee to the above mentioned products on our order confirmation. The basis for the copper price which we will invoice is available on: <http://www.lme.com/copper.asp>. We use the following formula for the copper surcharge: ((3-month buyer\*exchange rate USD vs. EURO)/1000\*copper weight)

## IP20 Box for AC Input Reactors 2 %

Ürün Kodu	Açıklama	Liste Fiyatı
IP20-BOX31	IP20 Box for AC input reactor type ALR3 40-2/2 to ALR3 40-2/6	57 EUR
IP20-BOX32	IP20 Box for AC input reactor type ALR3 40-2/10 to ALR3 40-2/45	60 EUR

## Harmonic Filters for V1000 400VAC (THD-I < 5%)

Ürün Kodu	Açıklama	Liste Fiyatı
HFM-FB 7-400	Harmonic Filter (THD-I < 5%) IP00 for CIMR-VC4A0001 to 0009. 10 Amp., 3,50 kg copper	2.238 EUR
HFM-FB 13-400	Harmonic Filter (THD-I < 5%) IP00 for CIMR-VC4A0011, 0018. 19 Amp., 4,50 kg copper	2.617 EUR
HFM-FB 18-400	Harmonic Filter (THD-I < 5%) IP00 for CIMR-VC4A0023. 26 Amp., 7,00 kg copper	3.571 EUR
HFM-FB 30-400	Harmonic Filter (THD-I < 5%) IP00 for CIMR-VC4A0031, 0038. 43 Amp., 11,50 kg copper	5.102 EUR

Please note that we will add a copper fee to the above mentioned products on our order confirmation. The basis for the copper price which we will invoice is available on: <http://www.lme.com/copper.asp>. We use the following formular for the copper surcharge: ((3-month buyer\*exchange rate USD vs. EURO)/1000\*copper weight)  
IP20 Filters are available on request. Please contact your local Yaskawa representative for further information.

## AC Output Reactors IP00 for V1000 400VAC (up to 120 Hz Output Frequency)

Ürün Kodu	Açıklama	Liste Fiyatı
MDB 400/6,3	AC Output Reactor IP00 up to 120 Hz Output Frequency for CIMR-VC4A0001, 0002, 0004, 0005. 6,3 Amp., 0,70 kg copper	204 EUR
MDB 400/13	AC Output Reactor IP00 up to 120 Hz Output Frequency for CIMR-VC4A0007, 0009. 13 Amp., 0,90 kg copper	236 EUR
MDB 400/24	AC Output Reactor IP00 up to 120 Hz Output Frequency for CIMR-VC4A0011, 0018, 0023*. 24 Amp., 1,30 kg copper	371 EUR
MDB 400/46	AC Output Reactor IP00 up to 120 Hz Output Frequency for CIMR-VC4A0023*, 0031, 0038. 46 Amp., 1,70 kg copper	452 EUR

Please note that we will add a copper fee to the above mentioned products on our order confirmation. The basis for the copper price which we will invoice is available on: <http://www.lme.com/copper.asp>. We use the following formular for the copper surcharge: ((3-month buyer\*exchange rate USD vs. EURO)/1000\*copper weight)  
\* When you are using 8 kHz choose MDB 400/46.

## IP20 Box for AC Output Reactors IP00 (up to 120 Hz Output Frequency)

Ürün Kodu	Açıklama	Liste Fiyatı
IP20-BOX31	IP20 Box for AC Output Reactor MDB 400/6,3	57 EUR
IP20-BOX32	IP20 Box for AC Output Reactor MDB 400/13	60 EUR
IP20-BOX36	IP20 Box for AC Output Reactor MDB 400/24	74 EUR
IP20-BOX37	IP20 Box for AC Output Reactor MDB 400/46	81 EUR

## AC Output Reactors IP00 for V1000 400VAC (up to 50 Hz Output Frequency)

Ürün Kodu	Açıklama	Liste Fiyatı
MR3 400/4	AC Output Reactor IP00 up to 50 Hz Output Frequency for CIMR-VC4A0001, 0002. 4,0 Amp., 0,10 kg copper	92 EUR
MR3 400/10	AC Output Reactor IP00 up to 50 Hz Output Frequency for CIMR-VC4A0004, 0005, 0007, 0009. 10 Amp., 0,20 kg copper	117 EUR
MR3 400/18	AC Output Reactor IP00 up to 50 Hz Output Frequency for CIMR-VC4A0011. 18 Amp., 0,40 kg copper	143 EUR
MR3 400/24	AC Output Reactor IP00 up to 50 Hz Output Frequency for CIMR-VC4A0018, 0023*. 24 Amp., 0,50 kg copper	164 EUR
MR3 400/37	AC Output Reactor IP00 up to 50 Hz Output Frequency for CIMR-VC4A0023*. 37 Amp., 0,70 kg copper	207 EUR
MR3 400/48	AC Output Reactor IP00 up to 50 Hz Output Frequency for CIMR-VC4A0031, 0038. 48 Amp., 1,10 kg copper	280 EUR

Please note that we will add a copper fee to the above mentioned products on our order confirmation. The basis for the copper price which we will invoice is available on: <http://www.lme.com/copper.asp>. We use the following formula for the copper surcharge: ((3-month buyer\*exchange rate USD vs. EURO)/1000\*copper weight)

\* When you are using 8 kHz choose MR3 400/37.

## IP20 Box for AC Output Reactors IP00 (up to 50 Hz Output Frequency)

Ürün Kodu	Açıklama	Liste Fiyatı
IP20-BOX31	IP20 Box for AC Output Reactor MR3 400/4	57 EUR
IP20-BOX32	IP20 Box for AC Output Reactor MR3 400/10 to MR3 400/24	60 EUR
IP20-BOX33	IP20 Box for AC Output Reactor MR3 400/37	62 EUR
IP20-BOX35	IP20 Box for AC Output Reactor MR3 400/48	70 EUR

## Inverter V1000 200 VAC Single Phase - IP20

Ürün Kodu	Açıklama	Liste Fiyatı
CIMR-VCBA0001BAA	Inverter V1000, 200 V, ND: 1,2 A / 0,2 kW, HD: 0,8 A / 0,1 kW, IP20	230 EUR
CIMR-VCBA0002BAA	Inverter V1000, 200 V, ND: 1,9 A / 0,4 kW, HD: 1,6 A / 0,2 kW, IP20	238 EUR
CIMR-VCBA0003BAA	Inverter V1000, 200 V, ND: 3,3 A / 0,75 kW, HD: 3 A / 0,4 kW, IP20	249 EUR
CIMR-VCBA0006BAA	Inverter V1000, 200 V, ND: 6 A / 1,1 kW, HD: 5 A / 0,75 kW, IP20	291 EUR
CIMR-VCBA0010BAA	Inverter V1000, 200 V, ND: 9,6 A / 2,2 kW, HD: 8 A / 1,5 kW, IP20	346 EUR
CIMR-VCBA0012BAA	Inverter V1000, 200 V, ND: 12 A / 3 kW, HD: 11 A / 2,2 kW, IP20	405 EUR
CIMR-VCBA0018BAA	Inverter V1000, 200 V, HD: 17,5 A / 4 kW, IP20	506 EUR



## Inverter V1000 200 VAC Single Phase - Cold Plate

Ürün Kodu	Açıklama	Liste Fiyatı
CIMR-VCBA0001JAB	Inverter V1000, 200 V, ND: 1,2 A / 0,2 kW, HD: 0,8 A / 0,1 kW, Cold Plate	265 EUR
CIMR-VCBA0002JAB	Inverter V1000, 200 V, ND: 1,9 A / 0,4 kW, HD: 1,6 A / 0,2 kW, Cold Plate	275 EUR
CIMR-VCBA0003JAB	Inverter V1000, 200 V, ND: 3,3 A / 0,75 kW, HD: 3 A / 0,4 kW, Cold Plate	287 EUR
CIMR-VCBA0006JAB	Inverter V1000, 200 V, ND: 6 A / 1,1 kW, HD: 5 A / 0,75 kW, Cold Plate	334 EUR
CIMR-VCBA0010JAB	Inverter V1000, 200 V, ND: 9,6 A / 2,2 kW, HD: 8 A / 1,5 kW, Cold Plate	401 EUR
CIMR-VCBA0012JAB	Inverter V1000, 200 V, ND: 12 A / 3 kW, HD: 11 A / 2,2 kW, Cold Plate	463 EUR

## Inverter V1000 200 VAC Single Phase - IP66

Ürün Kodu	Açıklama	Liste Fiyatı
CIMR-VCBA0001HAA-0080	Inverter V1000, 200 V, ND: 1,2 A / 0,2 kW, HD: 0,8 A / 0,1 kW, IP66 with Digital Operator	910 EUR
CIMR-VCBA0002HAA-0080	Inverter V1000, 200 V, ND: 1,9 A / 0,4 kW, HD: 1,6 A / 0,2 kW, IP66 with Digital Operator	930 EUR
CIMR-VCBA0003HAA-0080	Inverter V1000, 200 V, ND: 3,3 A / 0,75 kW, HD: 3 A / 0,4 kW, IP66 with Digital Operator	945 EUR
CIMR-VCBA0006HAA-0080	Inverter V1000, 200 V, ND: 6 A / 1,1 kW, HD: 5 A / 0,75 kW, IP66 with Digital Operator	1.131 EUR
CIMR-VCBA0010HAA-0080	Inverter V1000, 200 V, ND: 9,6 A / 2,2 kW, HD: 8 A / 1,5 kW, IP66 with Digital Operator	1.224 EUR
CIMR-VCBA0012HAA-0080	Inverter V1000, 200 V, ND: 12 A / 3 kW, HD: 11 A / 2,2 kW, IP66 with Digital Operator	1.262 EUR
CIMR-VCBA0001HAA-0081	Inverter V1000, 200 V, ND: 1,2 A / 0,2 kW, HD: 0,8 A / 0,1 kW, IP66 with RJ45	865 EUR
CIMR-VCBA0002HAA-0081	Inverter V1000, 200 V, ND: 1,9 A / 0,4 kW, HD: 1,6 A / 0,2 kW, IP66 with RJ45	883 EUR
CIMR-VCBA0003HAA-0081	Inverter V1000, 200 V, ND: 3,3 A / 0,75 kW, HD: 3 A / 0,4 kW, IP66 with RJ45	900 EUR
CIMR-VCBA0006HAA-0081	Inverter V1000, 200 V, ND: 6 A / 1,1 kW, HD: 5 A / 0,75 kW, IP66 with RJ45	1.080 EUR
CIMR-VCBA0010HAA-0081	Inverter V1000, 200 V, ND: 9,6 A / 2,2 kW, HD: 8 A / 1,5 kW, IP66 with RJ45	1.169 EUR
CIMR-VCBA0012HAA-0081	Inverter V1000, 200 V, ND: 12 A / 3 kW, HD: 11 A / 2,2 kW, IP66 with RJ45	1.209 EUR

Internal filter supplied no additional filter required.

## Inverter V1000 200 VAC Single Phase - IP20 with 1000 Hz Software

Ürün Kodu	Açıklama	Liste Fiyatı
CIMR-VCBB0001BAA	Inverter V1000, 200 V, HD: 0,8 A / 0,1 kW, IP20 & 1000 Hz Software	690 EUR
CIMR-VCBB0002BAA	Inverter V1000, 200 V, HD: 1,6 A / 0,2 kW, IP20 & 1000 Hz Software	699 EUR
CIMR-VCBB0003BAA	Inverter V1000, 200 V, HD: 3 A / 0,4 kW, IP20 & 1000 Hz Software	712 EUR
CIMR-VCBB0006BAA	Inverter V1000, 200 V, HD: 5 A / 0,75 kW, IP20 & 1000 Hz Software	764 EUR
CIMR-VCBB0010BAA	Inverter V1000, 200 V, HD: 8 A / 1,5 kW, IP20 & 1000 Hz Software	827 EUR
CIMR-VCBB0012BAA	Inverter V1000, 200 V, HD: 11 A / 2,2 kW, IP20 & 1000 Hz Software	899 EUR

## EMC Line-Filters for V1000 200 VAC Single Phase

Ürün Kodu	Açıklama	Liste Fiyatı
FS23638-10-07	EMC Line-Filter for CIMR-VCBA0001, 0002, 0003. EN61800-3 Class C1, 10 Amp.	32 EUR
FS23638-20-07	EMC Line-Filter for CIMR-VCBA0006, 0010. EN61800-3 Class C1, 20 Amp.	49 EUR
FS23638-30-07	EMC Line-Filter for CIMR-VCBA0012. EN61800-3 Class C1, 30 Amp.	60 EUR
FS23638-40-07	EMC Line-Filter for CIMR-VCBA0018. EN61800-3 Class C1, 40 Amp.	83 EUR

All filters are footmount

## Inverter V1000 200 VAC Three Phase - IP20/NEMA1

Ürün Kodu	Açıklama	Liste Fiyatı
CIMR-VC2A0001BAA	Inverter V1000, 200 V, ND: 1,2 A / 0,2 kW, HD: 0,8 A / 0,1 kW, IP20	257 EUR
CIMR-VC2A0002BAA	Inverter V1000, 200 V, ND: 1,9 A / 0,4 kW, HD: 1,6 A / 0,2 kW, IP20	257 EUR
CIMR-VC2A0004BAA	Inverter V1000, 200 V, ND: 3,5 A / 0,75 kW, HD: 3 A / 0,4 kW, IP20	263 EUR
CIMR-VC2A0006BAA	Inverter V1000, 200 V, ND: 6 A / 1,1 kW, HD: 5 A / 0,75 kW, IP20	297 EUR
CIMR-VC2A0010BAA	Inverter V1000, 200 V, ND: 9,6 A / 2,2 kW, HD: 8 A / 1,5 kW, IP20	360 EUR
CIMR-VC2A0012BAA	Inverter V1000, 200 V, ND: 12 A / 3 kW, HD: 11 A / 2,2 kW, IP20	395 EUR
CIMR-VC2A0020BAA	Inverter V1000, 200 V, ND: 19,6 A / 5,5 kW, HD: 17,5 A / 4 kW, IP20	495 EUR
CIMR-VC2A0030FAA	Inverter V1000, 200 V, ND: 30 A / 7,5 kW, HD: 25 A / 5,5 kW, NEMA1	1.037 EUR
CIMR-VC2A0040FAA	Inverter V1000, 200 V, ND: 40 A / 11 kW, HD: 33 A / 7,5 kW, NEMA1	1.181 EUR
CIMR-VC2A0056FAA	Inverter V1000, 200 V, ND: 56 A / 15 kW, HD: 47 A / 11 kW, NEMA1	1.844 EUR
CIMR-VC2A0069FAA	Inverter V1000, 200 V, ND: 69 A / 18,5 kW, HD: 60 A / 15 kW, NEMA1	2.574 EUR

## Inverter V1000 200 VAC Three Phase - Cold Plate

Ürün Kodu	Açıklama	Liste Fiyatı
CIMR-VC2A0001JAB	Inverter V1000, 200 V, ND: 1,2 A / 0,2 kW, HD: 0,8 A / 0,1 kW, Cold Plate	288 EUR
CIMR-VC2A0002JAB	Inverter V1000, 200 V, ND: 1,9 A / 0,4 kW, HD: 1,6 A / 0,2 kW, Cold Plate	288 EUR
CIMR-VC2A0004JAB	Inverter V1000, 200 V, ND: 3,5 A / 0,75 kW, HD: 3 A / 0,4 kW, Cold Plate	292 EUR
CIMR-VC2A0006JAB	Inverter V1000, 200 V, ND: 6 A / 1,1 kW, HD: 5 A / 0,75 kW, Cold Plate	327 EUR
CIMR-VC2A0010JAB	Inverter V1000, 200 V, ND: 9,6 A / 2,2 kW, HD: 8 A / 1,5 kW, Cold Plate	396 EUR
CIMR-VC2A0012JAB	Inverter V1000, 200 V, ND: 12 A / 3 kW, HD: 11 A / 2,2 kW, Cold Plate	438 EUR
CIMR-VC2A0020JAB	Inverter V1000, 200 V, ND: 19,6 A / 5,5 kW, HD: 17,5 A / 4 kW, Cold Plate	547 EUR
CIMR-VC2A0030JAB	Inverter V1000, 200 V, ND: 30 A / 7,5 kW, HD: 25 A / 5,5 kW, Cold Plate	1.147 EUR
CIMR-VC2A0040JAB	Inverter V1000, 200 V, ND: 40 A / 11 kW, HD: 33 A / 7,5 kW, Cold Plate	1.306 EUR
CIMR-VC2A0056JAB	Inverter V1000, 200 V, ND: 56 A / 15 kW, HD: 47 A / 11 kW, Cold Plate	2.041 EUR

## EMC Line-Filters for V1000 200 VAC Three Phase

Ürün Kodu	Açıklama	Liste Fiyatı
FS23637-8-07	EMC Line-Filter for CIMR-VC2A0001, 0002, 0004, 0006. EN61800-3 Class C1, 08 Amp.	85 EUR
FS23637-14-07	EMC Line-Filter for CIMR-VC2A0010, 0012. EN61800-3 Class C1, 14 Amp.	104 EUR
FS23637-24-07	EMC Line-Filter for CIMR-VC2A0020. EN61800-3 Class C1, 24 Amp.	129 EUR
FS23637-52-07	EMC Line-Filter for CIMR-VC2A0030, 0040. EN61800-3 Class C1, 52 Amp.	254 EUR
FS23637-68-07	EMC Line-Filter for CIMR-VC2A0056. EN61800-3 Class C1, 68 Amp.	297 EUR
FS23637-80-07	EMC Line-Filter for CIMR-VC2A0069. EN61800-3 Class C1, 80 Amp.	328 EUR

All filters are footmount

## Options for V1000 Series

Ürün Kodu	Açıklama	Liste Fiyatı
EZZ020568A	Heatsink external Attachment V1000, T1000V 230V 1A, 2A / 200V 1A, 2A	28 EUR
EZZ020568B	Heatsink external Attachment V1000, T1000V 230V 3A / 200V 4A	28 EUR
EZZ020568C	Heatsink external Attachment V1000, T1000V 230V 6A / 400V 2A, 4A	28 EUR
EZZ020568D	Heatsink external Attachment V1000, T1000V 230V 10A / 200V 10A, 12A / 400V 5A, 7A, 9A	49 EUR
EZZ020568E	Heatsink external Attachment V1000, T1000V 230V 12A / 200V 20A / 400V 11A	53 EUR
EZZ020568F	Heatsink external Attachment V1000 230V 18A	102 EUR
EZZ020568G	Heatsink external Attachment V1000, T1000V 200V 6A	32 EUR
EZZ020568H	Heatsink external Attachment V1000, T1000V 230V 30A, 40A / 400V 18A, 23A	67 EUR
EZZ020568J	Heatsink external Attachment V1000, T1000V 200V 56A / 400V 31A, 38A	74 EUR
EZZ020568K	Heatsink external Attachment V1000, T1000V 200V 69A	74 EUR
EZZ020568L	Heatsink external Attachment V1000, T1000V 400V 1A	38 EUR
EUOP-V11001	IP54/65 Operator Frame	25 EUR
EZZ08122A	DIN Rail Attachment V1000 230V 1A, 2A, 3A / 200V 1A, 2A, 4A, 6A	14 EUR
EZZ08122B	DIN Rail Attachment V1000 230V 6A, 10A, / 200V 8A, 10A, 12A / 400V 1A, 2A, 4A, 5A, 7A, 9A	14 EUR
EZZ08122C	DIN Rail Attachment V1000 230V 12A / 200V 18A, 20A / 400V 11A	14 EUR
EZZ08122D	DIN Rail Attachment 230V 18A	14 EUR
JVOP-180	LCD Operator 1000 Series	133 EUR
JVOP-181	Copy unit w/USB converter	232 EUR
JVOP-182	LED Operator 1000 Series	63 EUR
MANUAL	Technical Manual - Printed Version - for V1000 Series	64 EUR
PS-V10S	ext.24V power supply upto 4kW	133 EUR
PS-V10M	ext.24V power supply 5.5-15kW	137 EUR
JVOP-TBVA03BAA	V1000 Terminal board for parallel connection of STO inputs, Dual channel STO, screw terminals	98 EUR
SI-C3/V	Comm.Interface V1000 CC Link	280 EUR
SI-EL3/V	Comm.Interface V1000 Powerlink	579 EUR
SI-EN3/V	Comm.Interface V1000 EtherNet IP	369 EUR
SI-EN3D/V	Comm. Interface V1000 Dual Port EtherNet IP	484 EUR
SI-EM3/V	Comm.Interface V1000 Modbus TCP	365 EUR
SI-EP3/V	Comm.Interface V1000 ProfiNet	556 EUR
EUOP-SI-ES3/V	Comm.Interface V1000 EtherCAT	467 EUR
SI-ES3/V	Comm.Interface V1000 EtherCAT *1	380 EUR
SI-N3/V	Comm.Interface V1000 DeviceNet	196 EUR
SI-P3/V	Comm.Interface V1000 Profibus DP	344 EUR
SI-S3/V	Comm.Interface V1000 CANopen	214 EUR
SI-T3/V	Comm.Interface V1000 Mechatrolink II	228 EUR
SI-ET3/V	Comm.Interface V1000 Mechatrolink III	351 EUR
WV001-YEG	1m extension cable for remote Digital Operator	51 EUR
WV003-YEG	3m extension cable for remote Digital Operator	60 EUR

\*1: Note: The SI-ES/V option card will replace the EUOP-SI-ES3/V card. Both cards will be available in parallel for a certain period of time. On the SI-ES3/V card a few functions work in a different way than on the EUOP-SI-ES3/V card. Therefore we recommend:

- not to mix SI-ES3/V and EUOP-SI-ES3/V cards in one project.
  - use the SI-ES3/V, NOT EUOP-SI-ES3/V for new projects.
- Information on compatibility can be obtained from our technical support.



## T 1000V Inverter

- @ 0,1 - 15kW
- @ 200VAC & 400VAC
- @ 6 dig. Input / 1 Pulse Input / 2 analog Input
- @ 1 Pulse Output / 1 Analog Output / 1 Relay output / 2 Photocoupler Output
- @ V/f / Open Loop Vector for IM (Vector for PM)

### Inverter T1000V 400 VAC Three Phase - IP20 / NEMA1

Ürün Kodu	Açıklama	Liste Fiyatı
CIMR-TC4V0001BMA	Inverter T1000V, 400 V, ND: 1,2 A / 0,4 kW, HD: 1,2 A / 0,2 kW, IP20	478 EUR
CIMR-TC4V0002BMA	Inverter T1000V, 400 V, ND: 2,1 A / 0,75 kW, HD: 1,8 A / 0,4 kW, IP20	510 EUR
CIMR-TC4V0004BMA	Inverter T1000V, 400 V, ND: 4,1 A / 1,5 kW, HD: 3,4 A / 0,75 kW, IP20	716 EUR
CIMR-TC4V0005BMA	Inverter T1000V, 400 V, ND: 5,4 A / 2,2 kW, HD: 4,8 A / 1,5 kW, IP20	864 EUR
CIMR-TC4V0007BMA	Inverter T1000V, 400 V, ND: 6,9 A / 3 kW, HD: 5,5 A / 2,2 kW, IP20	912 EUR
CIMR-TC4V0009BMA	Inverter T1000V, 400 V, ND: 8,8 A / 3,7 kW, HD: 7,2 A / 3 kW, IP20	967 EUR
CIMR-TC4V0011BMA	Inverter T1000V, 400 V, ND: 11,1 A / 5,5 kW, HD: 9,2 A / 4 kW, IP20	986 EUR
CIMR-TC4V0018AMA	Inverter T1000V, 400 V, ND: 17,5 A / 7,5 kW, HD: 14,8 A / 5,5 kW, NEMA 1	1.126 EUR
CIMR-TC4V0023AMA	Inverter T1000V, 400 V, ND: 23 A / 11 kW, HD: 18 A / 7,5 kW, NEMA 1	1.169 EUR
CIMR-TC4V0031AMA	Inverter T1000V, 400 V, ND: 31 A / 15 kW, HD: 24 A / 11 kW, NEMA 1	1.607 EUR
CIMR-TC4V0038AMA	Inverter T1000V, 400 V, ND: 38 A / 18,5 kW, HD: 31 A / 15 kW, NEMA 1	1.941 EUR

### Inverter T1000V 400 VAC Three Phase - Cold Plate

Ürün Kodu	Açıklama	Liste Fiyatı
CIMR-TC4V0001JMB	Inverter T1000V, 400 V, ND: 1,2 A / 0,4 kW, HD: 1,2 A / 0,2 kW, Cold Plate	439 EUR
CIMR-TC4V0002JMB	Inverter T1000V, 400 V, ND: 2,1 A / 0,75 kW, HD: 1,8 A / 0,4 kW, Cold Plate	472 EUR
CIMR-TC4V0004JMB	Inverter T1000V, 400 V, ND: 4,1 A / 1,5 kW, HD: 3,4 A / 0,75 kW, Cold Plate	640 EUR
CIMR-TC4V0005JMB	Inverter T1000V, 400 V, ND: 5,4 A / 2,2 kW, HD: 4,8 A / 1,5 kW, Cold Plate	1.135 EUR
CIMR-TC4V0007JMB	Inverter T1000V, 400 V, ND: 6,9 A / 3 kW, HD: 5,5 A / 2,2 kW, Cold Plate	1.165 EUR
CIMR-TC4V0009JMB	Inverter T1000V, 400 V, ND: 8,8 A / 3,7 kW, HD: 7,2 A / 3 kW, Cold Plate	1.202 EUR
CIMR-TC4V0011JMB	Inverter T1000V, 400 V, ND: 11,1 A / 5,5 kW, HD: 9,2 A / 4 kW, Cold Plate	1.230 EUR
CIMR-TC4V0018JMB	Inverter T1000V, 400 V, ND: 17,5 A / 7,5 kW, HD: 14,8 A / 5,5 kW, Cold Plate	1.255 EUR
CIMR-TC4V0023JMB	Inverter T1000V, 400 V, ND: 23 A / 11 kW, HD: 18 A / 7,5 kW, Cold Plate	1.283 EUR
CIMR-TC4V0031JMB	Inverter T1000V, 400 V, ND: 31 A / 15 kW, HD: 24 A / 11 kW, Cold Plate	1.881 EUR
CIMR-TC4V0038JMB	Inverter T1000V, 400 V, ND: 38 A / 18,5 kW, HD: 31 A / 15 kW, Cold Plate	2.276 EUR

Ürün Kodu	Açıklama	Liste Fiyatı
FS23639-5-07	EMC Line-Filter for CIMR-TC4V0001, 0002, 0004. EN61800-3 Class C1, 05 Amp.	58 EUR
FS23639-10-07	EMC Line-Filter for CIMR-TC4V0005, 0007, 0009. EN61800-3 Class C1, 10 Amp.	73 EUR
FS23639-15-07	EMC Line-Filter for CIMR-TC4V0011. EN61800-3 Class C1, 15 Amp.	92 EUR
FS23639-30-07	EMC Line-Filter for CIMR-TC4V0018, 0023. EN61800-3 Class C1, 30 Amp.	101 EUR
FS23639-50-07	EMC Line-Filter for CIMR-TC4V0031, 00038. EN61800-3 Class C1, 50 Amp.	186 EUR

## Inverter T1000V 200 VAC Single Phase - IP20

Ürün Kodu	Açıklama	Liste Fiyatı
CIMR-TCBV0001BMA	Inverter T1000V, 200 V, ND: 1,2 A / 0,2 kW, HD: 0,8 A / 0,1 kW, IP20	336 EUR
CIMR-TCBV0002BMA	Inverter T1000V, 200 V, ND: 1,9 A / 0,4 kW, HD: 1,6 A / 0,2 kW, IP20	342 EUR
CIMR-TCBV0003BMA	Inverter T1000V, 200 V, ND: 3,3 A / 0,75 kW, HD: 3 A / 0,4 kW, IP20	358 EUR
CIMR-TCBV0006BMA	Inverter T1000V, 200 V, ND: 6 A / 1,1 kW, HD: 5 A / 0,75 kW, IP20	410 EUR
CIMR-TCBV0010BMA	Inverter T1000V, 200 V, ND: 9,6 A / 2,2 kW, HD: 8 A / 1,5 kW, IP20	512 EUR
CIMR-TCBV0012BMA	Inverter T1000V, 200 V, ND: 12 A / 3 kW, HD: 11 A / 2,2 kW, IP20	585 EUR

## Inverter T1000V 200 VAC Single Phase - Cold Plate

Ürün Kodu	Açıklama	Liste Fiyatı
CIMR-TCBV0001JMB	Inverter T1000V, 200 V, ND: 1,2 A / 0,2 kW, HD: 0,8 A / 0,1 kW, Cold Plate	453 EUR
CIMR-TCBV0002JMB	Inverter T1000V, 200 V, ND: 1,9 A / 0,4 kW, HD: 1,6 A / 0,2 kW, Cold Plate	462 EUR
CIMR-TCBV0003JMB	Inverter T1000V, 200 V, ND: 3,3 A / 0,75 kW, HD: 3 A / 0,4 kW, Cold Plate	474 EUR
CIMR-TCBV0006JMB	Inverter T1000V, 200 V, ND: 6 A / 1,1 kW, HD: 5 A / 0,75 kW, Cold Plate	531 EUR
CIMR-TCBV0010JMB	Inverter T1000V, 200 V, ND: 9,6 A / 2,2 kW, HD: 8 A / 1,5 kW, Cold Plate	594 EUR
CIMR-TCBV0012JMB	Inverter T1000V, 200 V, ND: 12 A / 3 kW, HD: 11 A / 2,2 kW, Cold Plate	669 EUR

## EMC Line-Filters for T1000V 200 VAC Single Phase

Ürün Kodu	Açıklama	Liste Fiyatı
FS23638-10-07	EMC Line-Filter for CIMR-TCBV0001, 0002, 0003. EN61800-3 Class C1, 10 Amp.	32 EUR
FS23638-20-07	EMC Line-Filter for CIMR-TCBV0006, 0010. EN61800-3 Class C1, 20 Amp.	49 EUR
FS23638-30-07	EMC Line-Filter for CIMR-TCBV0012. EN61800-3 Class C1, 30 Amp.	60 EUR
FS23638-40-07	EMC Line-Filter for CIMR-TCBV0018. EN61800-3 Class C1, 40 Amp.	83 EUR

## Options for T1000V Series

Ürün Kodu	Açıklama	Liste Fiyatı
EZZ020568A	Heatsink external Attachment V1000, T1000V 230V 1A, 2A / 200V 1A, 2A	28 EUR
EZZ020568B	Heatsink external Attachment V1000, T1000V 230V 3A / 200V 4A	28 EUR
EZZ020568C	Heatsink external Attachment V1000, T1000V 230V 6A / 400V 2A, 4A	28 EUR
EZZ020568D	Heatsink external Attachment V1000, T1000V 230V 10A / 200V 10A, 12A / 400V 5A, 7A, 9A	49 EUR
EZZ020568E	Heatsink external Attachment V1000, T1000V 230V 12A / 200V 20A / 400V 11A	53 EUR
EZZ020568G	Heatsink external Attachment V1000, T1000V 200V 6A	32 EUR
EZZ020568H	Heatsink external Attachment V1000, T1000V 230V 30A, 40A / 400V 18A, 23A	67 EUR
EZZ020568J	Heatsink external Attachment V1000, T1000V 200V 56A / 400V 31A, 38A	74 EUR
EZZ020568K	Heatsink external Attachment V1000, T1000V 200V 69A	74 EUR
EZZ020568L	Heatsink external Attachment V1000, T1000V 400V 1A	38 EUR
EZZ08122A	DIN Rail Attachment	14 EUR
EZZ08122B	DIN Rail Attachment	14 EUR
EZZ08122D	DIN Rail Attachment	14 EUR
JVOP-180	LCD Operator 1000 Series	133 EUR
JVOP-181	Copy unit w/USB converter	232 EUR
JVOP-182	LED Operator 1000 Series	63 EUR
MANUAL	Technical Manual - Printed Version - for T1000V Series	64 EUR
PS-V10S	ext.24V power supply upto 4kW	133 EUR
PS-V10M	ext.24V power supply 5,5-15kW	137 EUR
SI-C3/V	Comm.Interface T1000V CC Link	280 EUR
SI-EL3/V	Comm.Interface T1000V Powerlink	579 EUR
SI-EN3/V	Comm.Interface T1000V EtherNet IP	369 EUR
SI-EM3/V	Comm.Interface T1000V Modbus TCP	365 EUR
SI-EP3/V	Comm.Interface T1000V ProfiNet	556 EUR
EUOP-SI-ES3/V	Comm.Interface T1000V EtherCAT	467 EUR
SI-ES3/V	Comm.Interface V1000 EtherCAT *1	380 EUR
SI-N3/V	Comm.Interface T1000V DeviceNet	196 EUR
SI-P3/V	Comm.Interface T1000V Profibus DP	344 EUR
SI-S3/V	Comm.Interface T1000V CANopen	214 EUR
SI-T3/V	Comm.Interface T1000V Mechatrolink II	228 EUR
WV001-YEG	1m extension cable for remote Digital Operator	51 EUR
WV003-YEG	3m extension cable for remote Digital Operator	60 EUR



\*1: Note: The SI-ES/V option card will replace the EUOP-SI-ES3/V card. Both cards will be available in parallel for a certain period of time. On the SI-ES3/V card a few functions work in a different way than on the EUOP-SI-ES3/V card. Therefore we recommend:

- a) not to mix SI-ES3/V and EUOP-SI-ES3/V cards in one project.
- b) use the SI-ES3/V, NOT EUOP-SI-ES3/V for new projects.

Information on compatibility can be obtained from our technical support.



## L 1000V Inverter

- @ 4 - 15kW
- @ 200VAC & 400VAC
- @ 7 dig. Input / 1 Pulse Input / 1 Safety Input
- @ 2 Relay Output / 1 Open Collector Output / 1 Analogue Output
- @ V/f control / Open Loop Vector / V/f with simple PG feedback
- @ SAFETY EN 61508 SIL2, ISO 13849-1 PLd
- @ EN81 one contactor solution

### Inverter L1000V 400 VAC Three Phase - IP20 / NEMA1

Ürün Kodu	Açıklama	Liste Fiyatı
CIMR-LC4V0009BAA	Inverter L1000V, 400 V, HD: 9,2 A / 4 kW, IP20	1.200 EUR
CIMR-LC4V0015FAA	Inverter L1000V, 400 V, HD: 15 A / 5,5 kW, NEMA1	1.339 EUR
CIMR-LC4V0018FAA	Inverter L1000V, 400 V, HD: 18 A / 7,5 kW, NEMA1	1.560 EUR
CIMR-LC4V0024FAA	Inverter L1000V, 400 V, HD: 24 A / 11 kW, NEMA1	2.122 EUR
CIMR-LC4V0031FAA	Inverter L1000V, 400 V, HD: 31 A / 15 kW, NEMA1	2.390 EUR

### EMC Line-Filters for L1000V 400 VAC

Ürün Kodu	Açıklama	Liste Fiyatı
FS23639-15-07	EMC Line-Filter for CIMR-LC4V0009. EN61800-3 Class C1, 15 Amp.	92 EUR
FS23639-30-07	EMC Line-Filter for CIMR-LC4V0015, 0018. EN61800-3 Class C1, 30 Amp.	101 EUR
FS23639-50-07	EMC Line-Filter for CIMR-LC4V0024, 0031. EN61800-3 Class C1, 50 Amp.	186 EUR

### Line Reactors IP00 for L1000V 400 VAC

Ürün Kodu	Açıklama	Liste Fiyatı
B 1103136	Line Reactors IP00 for CIMR-LC4V0009. 8 Amp., 1,4 kg copper	129 EUR
B 1103138	Line Reactors IP00 for CIMR-LC4V0015, 0018. 16 Amp., 2,1 kg copper	170 EUR
B 1103139	Line Reactors IP00 for CIMR-LC4V0024. 21 Amp., 3,0 kg copper	243 EUR
B 1103140	Line Reactors IP00 for CIMR-LC4V0031. 27 Amp., 4,2 kg copper	284 EUR

Please note that we will add a copper fee to the above mentioned products on our order confirmation. The basis for the copper price which we will invoice is available on: <http://www.lme.com/copper.asp>. We use the following formular for the copper surcharge: ((3-month buyer\*exchange rate USD vs. EURO)/1000\*copper weight)

### IP20 Box for Line Reactors

Ürün Kodu	Açıklama	Liste Fiyatı
IP20-Box32	IP20 Box for Line Reactor B 1103136	60 EUR
IP20-Box35	IP20 Box for Line Reactor B 1103138	70 EUR
IP20-Box36	IP20 Box for Line Reactor B 1103139	74 EUR
IP20-Box37	IP20 Box for Line Reactor B 1103140	81 EUR

### Braking Resistor 50% ED

Ürün Kodu	Açıklama	Liste Fiyatı
RH-1000W120	Braking Resistors 50% ED for CIMR-LC4V0009, 0015. 1000W, 120Ohm	149 EUR
RH-1560W040	Braking Resistors 50% ED for CIMR-LC4V0018. 1560W, 40Ohm	187 EUR
RH-2700W025	Braking Resistors 50% ED for CIMR-LC4V0024. 2700W, 25Ohm	268 EUR
RH-3700W025	Braking Resistors 50% ED for CIMR-LC4V0031. 3700W, 25Ohm	324 EUR

## Inverter L1000V 200 VAC Three Phase - IP20 / NEMA1

Ürün Kodu	Açıklama	Liste Fiyatı
CIMR-LC2V0018BAA	Inverter L1000V, 200 V, HD: 17,5 A / 4 kW, IP20	1.211 EUR
CIMR-LC2V0025FAA	Inverter L1000V, 200 V, HD: 25 A / 5,5 kW, NEMA1	1.784 EUR
CIMR-LC2V0033FAA	Inverter L1000V, 200 V, HD: 33 A / 7,5 kW, NEMA1	1.950 EUR
CIMR-LC2V0047FAA	Inverter L1000V, 200 V, HD: 47 A / 11 kW, NEMA1	2.501 EUR
CIMR-LC2V0060FAA	Inverter L1000V, 200 V, HD: 60 A / 15 kW, NEMA1	3.300 EUR

## EMC Line-Filters for L1000V 200 VAC

Ürün Kodu	Açıklama	Liste Fiyatı
FS23637-24-07	EMC Line-Filter for CIMR-LC2V0018. EN61800-3 Class C1, 24 Amp.	129 EUR
FS23637-52-07	EMC Line-Filter for CIMR-LC2V0025, 0033, 0047. EN61800-3 Class C1, 52 Amp.	254 EUR
FS23637-68-07	EMC Line-Filter for CIMR-LC2V0060. EN61800-3 Class C1, 68 Amp.	297 EUR

## Options for L1000V Series

Ürün Kodu	Açıklama	Liste Fiyatı
JVOP-180	LCD Operator 1000 Series	133 EUR
JVOP-181	Copy unit w/USB converter	232 EUR
JVOP-182	LED Operator 1000 Series	63 EUR
MANUAL	Technical Manual - Printed Version - for L1000V Series	64 EUR
WV001-YEG	1m extension cable for remote Digital Operator	51 EUR
WV003-YEG	3m extension cable for remote Digital Operator	60 EUR



## A1000 Inverter

- @ 0,4 - 630kW
- @ 200VAC & 400VAC
- @ 8 dig. Input / 1 Pulse Input / 2 Safety Inputs
- @ 1 Pulse Output / 2 Analog Output / 3 Relay Output / 1 Fault Relay / Safety Monitor
- @ V/f / Open Loop Vector / Advanced Open Loop Vector / Closed Loop Vector all for IM (Vector for PM), IM PM-, (SPM-, & IPM) motor control
- @ SAFETY EN 61508 SIL2, ISO 13849-1 PLd,

### Inverter A1000 400 VAC Three Phase - IP00 / NEMA1

Ürün Kodu	Açıklama	Liste Fiyatı
CIMR-AC4A0002FAA	Inverter A1000, 400 V, ND: 2,1 A / 0,75 kW, HD: 1,8 A / 0,55 kW, NEMA1	697 EUR
CIMR-AC4A0004FAA	Inverter A1000, 400 V, ND: 4,1 A / 1,5 kW, HD: 3,4 A / 0,75 kW, NEMA1	721 EUR
CIMR-AC4A0005FAA	Inverter A1000, 400 V, ND: 5,4 A / 2,2 kW, HD: 4,8 A / 1,5 kW, NEMA1	777 EUR
CIMR-AC4A0007FAA	Inverter A1000, 400 V, ND: 6,9 A / 3 kW, HD: 5,5 A / 2,2 kW, NEMA1	829 EUR
CIMR-AC4A0009FAA	Inverter A1000, 400 V, ND: 8,8 A / 4 kW, HD: 7,2 A / 3 kW, NEMA1	883 EUR
CIMR-AC4A0011FAA	Inverter A1000, 400 V, ND: 11,1 A / 5,5 kW, HD: 9,2 A / 4 kW, NEMA1	960 EUR
CIMR-AC4A0018FAA	Inverter A1000, 400 V, ND: 17,5 A / 7,5 kW, HD: 14,8 A / 5,5 kW, NEMA1	1.131 EUR
CIMR-AC4A0023FAA	Inverter A1000, 400 V, ND: 23 A / 11 kW, HD: 18 A / 7,5 kW, NEMA1	1.331 EUR
CIMR-AC4A0031FAA	Inverter A1000, 400 V, ND: 31 A / 15 kW, HD: 24 A / 11 kW, NEMA1	1.542 EUR
CIMR-AC4A0038FAA	Inverter A1000, 400 V, ND: 38 A / 18,5 kW, HD: 31 A / 15 kW, NEMA1	1.956 EUR
CIMR-AC4A0044FAA	Inverter A1000, 400 V, ND: 44 A / 22 kW, HD: 39 A / 18,5 kW, NEMA1	2.137 EUR
CIMR-AC4A0058AAA	Inverter A1000, 400 V, ND: 58 A / 30 kW, HD: 45 A / 22 kW, IP00	2.763 EUR
CIMR-AC4A0072AAA	Inverter A1000, 400 V, ND: 72 A / 37 kW, HD: 60 A / 30 kW, IP00	3.096 EUR
CIMR-AC4A0088AAA	Inverter A1000, 400 V, ND: 88 A / 45 kW, HD: 75 A / 37 kW, IP00	3.756 EUR
CIMR-AC4A0103AAA	Inverter A1000, 400 V, ND: 103 A / 55 kW, HD: 91 A / 45 kW, IP00	4.133 EUR
CIMR-AC4A0139AAA	Inverter A1000, 400 V, ND: 139 A / 75 kW, HD: 112 A / 55 kW, IP00	5.167 EUR
CIMR-AC4A0165AAA	Inverter A1000, 400 V, ND: 165 A / 90 kW, HD: 150 A / 75 kW, IP00	7.116 EUR
CIMR-AC4A0208AAA	Inverter A1000, 400 V, ND: 208 A / 110 kW, HD: 180 A / 90 kW, IP00	8.149 EUR
CIMR-AC4A0250AAA	Inverter A1000, 400 V, ND: 250 A / 132 kW, HD: 216 A / 110 kW, IP00	9.630 EUR
CIMR-AC4A0296AAA	Inverter A1000, 400 V, ND: 296 A / 160 kW, HD: 260 A / 132 kW, IP00	10.633 EUR
CIMR-AC4A0362AAA	Inverter A1000, 400 V, ND: 362 A / 185 kW, HD: 304 A / 160 kW, IP00	13.001 EUR
CIMR-AC4A0414AAA	Inverter A1000, 400 V, ND: 414 A / 220 kW, HD: 370 A / 185 kW, IP00	16.903 EUR
CIMR-AC4A0515AAA	Inverter A1000, 400 V, ND: 515 A / 250 kW, HD: 450 A / 220 kW, IP00	25.107 EUR
CIMR-AC4A0675AAA	Inverter A1000, 400 V, ND: 675 A / 355 kW, HD: 605 A / 315 kW, IP00	28.384 EUR
CIMR-AC4A0930AAA	Inverter A1000, 400 V, ND: 930 A / 500 kW, HD: 810 A / 450 kW, IP00	70.388 EUR
CIMR-AC4A1200AAA	Inverter A1000, 400 V, ND: 1200 A / 630 kW, HD: 1090 A / 560 kW, IP00	98.635 EUR



## Inverter A1000 400 VAC Three Phase - IP00 / NEMA1 with Crane Software

Ürün Kodu	Açıklama	Liste Fiyatı
CIMR-AC4A0002FAA-0048	Inverter A1000, 400 V, ND: 2,1 A / 0,75 kW, HD: 1,8 A / 0,55 kW, NEMA1 & Crane Software	721 EUR
CIMR-AC4A0004FAA-0048	Inverter A1000, 400 V, ND: 4,1 A / 1,5 kW, HD: 3,4 A / 0,75 kW, NEMA1 & Crane Software	744 EUR
CIMR-AC4A0005FAA-0048	Inverter A1000, 400 V, ND: 5,4 A / 2,2 kW, HD: 4,8 A / 1,5 kW, NEMA1 & Crane Software	798 EUR
CIMR-AC4A0007FAA-0048	Inverter A1000, 400 V, ND: 6,9 A / 3 kW, HD: 5,5 A / 2,2 kW, NEMA1 & Crane Software	855 EUR
CIMR-AC4A0009FAA-0048	Inverter A1000, 400 V, ND: 8,8 A / 4 kW, HD: 7,2 A / 3 kW, NEMA1 & Crane Software	905 EUR
CIMR-AC4A0011FAA-0048	Inverter A1000, 400 V, ND: 11,1 A / 5,5 kW, HD: 9,2 A / 4 kW, NEMA1 & Crane Software	986 EUR
CIMR-AC4A0018FAA-0048	Inverter A1000, 400 V, ND: 17,5 A / 7,5 kW, HD: 14,8 A / 5,5 kW, NEMA1 & Crane Software	1.154 EUR
CIMR-AC4A0023FAA-0048	Inverter A1000, 400 V, ND: 23 A / 11 kW, HD: 18 A / 7,5 kW, NEMA1 & Crane Software	1.355 EUR
CIMR-AC4A0031FAA-0048	Inverter A1000, 400 V, ND: 31 A / 15 kW, HD: 24 A / 11 kW, NEMA1 & Crane Software	1.565 EUR
CIMR-AC4A0038FAA-0048	Inverter A1000, 400 V, ND: 38 A / 18,5 kW, HD: 31 A / 15 kW, NEMA1 & Crane Software	1.979 EUR
CIMR-AC4A0044FAA-0048	Inverter A1000, 400 V, ND: 44 A / 22 kW, HD: 39 A / 18,5 kW, NEMA1 & Crane Software	2.162 EUR
CIMR-AC4A0058AAA-0048	Inverter A1000, 400 V, ND: 58 A / 30 kW, HD: 45 A / 22 kW, IP00 & Crane Software	2.788 EUR
CIMR-AC4A0072AAA-0048	Inverter A1000, 400 V, ND: 72 A / 37 kW, HD: 60 A / 30 kW, IP00 & Crane Software	3.119 EUR
CIMR-AC4A0088AAA-0048	Inverter A1000, 400 V, ND: 88 A / 45 kW, HD: 75 A / 37 kW, IP00 & Crane Software	3.778 EUR
CIMR-AC4A0103AAA-0048	Inverter A1000, 400 V, ND: 103 A / 55 kW, HD: 91 A / 45 kW, IP00 & Crane Software	4.159 EUR
CIMR-AC4A0139AAA-0048	Inverter A1000, 400 V, ND: 139 A / 75 kW, HD: 112 A / 55 kW, IP00 & Crane Software	5.193 EUR
CIMR-AC4A0165AAA-0048	Inverter A1000, 400 V, ND: 165 A / 90 kW, HD: 150 A / 75 kW, IP00 & Crane Software	7.141 EUR
CIMR-AC4A0208AAA-0048	Inverter A1000, 400 V, ND: 208 A / 110 kW, HD: 180 A / 90 kW, IP00 & Crane Software	7.540 EUR
CIMR-AC4A0250AAA-0048	Inverter A1000, 400 V, ND: 250 A / 132 kW, HD: 216 A / 110 kW, IP00 & Crane Software	10.223 EUR
CIMR-AC4A0296AAA-0048	Inverter A1000, 400 V, ND: 296 A / 160 kW, HD: 260 A / 132 kW, IP00 & Crane Software	11.285 EUR
CIMR-AC4A0362AAA-0048	Inverter A1000, 400 V, ND: 362 A / 185 kW, HD: 304 A / 160 kW, IP00 & Crane Software	13.789 EUR
CIMR-AC4A0414AAA-0048	Inverter A1000, 400 V, ND: 414 A / 220 kW, HD: 370 A / 185 kW, IP00 & Crane Software	24.646 EUR
CIMR-AC4A0515AAA-0048	Inverter A1000, 400 V, ND: 515 A / 250 kW, HD: 450 A / 220 kW, IP00 & Crane Software	29.867 EUR
CIMR-AC4A0675AAA-0048	Inverter A1000, 400 V, ND: 675 A / 355 kW, HD: 605 A / 315 kW, IP00 & Crane Software	37.682 EUR

## Inverter A1000 400 VAC Three Phase - IP00 / NEMA1 with 1000Hz Software

Ürün Kodu	Açıklama	Liste Fiyatı
CIMR-AC4B0002FAA-0064	Inverter A1000, 400 V, HD: 1,8 A / 0,55 kW, NEMA1 & 1000 Hz Software	707 EUR
CIMR-AC4B0004FAA-0064	Inverter A1000, 400 V, HD: 3,4 A / 0,75 kW, NEMA1 & 1000 Hz Software	730 EUR
CIMR-AC4B0005FAA-0064	Inverter A1000, 400 V, HD: 4,8 A / 1,5 kW, NEMA1 & 1000 Hz Software	784 EUR
CIMR-AC4B0007FAA-0064	Inverter A1000, 400 V, HD: 5,5 A / 2,2 kW, NEMA1 & 1000 Hz Software	836 EUR
CIMR-AC4B0009FAA-0064	Inverter A1000, 400 V, HD: 7,2 A / 3 kW, NEMA1 & 1000 Hz Software	887 EUR
CIMR-AC4B0011FAA-0064	Inverter A1000, 400 V, HD: 9,2 A / 4 kW, NEMA1 & 1000 Hz Software	963 EUR
CIMR-AC4B0018FAA-0064	Inverter A1000, 400 V, HD: 14,8 A / 5,5 kW, NEMA1 & 1000 Hz Software	1.131 EUR
CIMR-AC4B0023FAA-0064	Inverter A1000, 400 V, HD: 18 A / 7,5 kW, NEMA1 & 1000 Hz Software	1.331 EUR
CIMR-AC4B0031FAA-0064	Inverter A1000, 400 V, HD: 24 A / 11 kW, NEMA1 & 1000 Hz Software	1.535 EUR
CIMR-AC4B0038FAA-0064	Inverter A1000, 400 V, HD: 31 A / 15 kW, NEMA1 & 1000 Hz Software	1.939 EUR
CIMR-AC4B0044FAA-0064	Inverter A1000, 400 V, HD: 39 A / 18,5 kW, NEMA1 & 1000 Hz Software	2.118 EUR
CIMR-AC4B0058AAA-0064	Inverter A1000, 400 V, HD: 45 A / 22 kW, IP00 & 1000 Hz Software	2.733 EUR
CIMR-AC4B0072AAA-0064	Inverter A1000, 400 V, HD: 60 A / 30 kW, IP00 & 1000 Hz Software	3.057 EUR
CIMR-AC4B0088AAA-0064	Inverter A1000, 400 V, HD: 75 A / 37 kW, IP00 & 1000 Hz Software	3.704 EUR
CIMR-AC4B0103AAA-0064	Inverter A1000, 400 V, HD: 91 A / 45 kW, IP00 & 1000 Hz Software	4.079 EUR
CIMR-AC4B0139AAA-0064	Inverter A1000, 400 V, HD: 112 A / 55 kW, IP00 & 1000 Hz Software	5.090 EUR
CIMR-AC4B0165AAA-0064	Inverter A1000, 400 V, HD: 150 A / 75 kW, IP00 & 1000 Hz Software	6.998 EUR
CIMR-AC4B0208AAA-0064	Inverter A1000, 400 V, HD: 180 A / 90 kW, IP00 & 1000 Hz Software	8.013 EUR
CIMR-AC4B0250AAA-0064	Inverter A1000, 400 V, HD: 216 A / 110 kW, IP00 & 1000 Hz Software	9.465 EUR
CIMR-AC4B0296AAA-0064	Inverter A1000, 400 V, HD: 260 A / 132 kW, IP00 & 1000 Hz Software	10.449 EUR
CIMR-AC4B0362AAA-0064	Inverter A1000, 400 V, HD: 304 A / 160 kW, IP00 & 1000 Hz Software	12.770 EUR

## Inverter A1000 400 VAC Three Phase - IP54 Wall Mount

Ürün Kodu	Açıklama	Liste Fiyatı
CIMR-AC4A0044TAA	Inverter A1000, 400 V, ND: 44 A / 22 kW, HD: 39 A / 18,5 kW, IP54 Wall Mount	3.994 EUR
CIMR-AC4A0058TAA	Inverter A1000, 400 V, ND: 58 A / 30 kW, HD: 45 A / 22 kW, IP54 Wall Mount	5.031 EUR
CIMR-AC4A0072TAA	Inverter A1000, 400 V, ND: 72 A / 37 kW, HD: 60 A / 30 kW, IP54 Wall Mount	6.314 EUR
CIMR-AC4A0088TAA	Inverter A1000, 400 V, ND: 88 A / 45 kW, HD: 75 A / 37 kW, IP54 Wall Mount	8.175 EUR
CIMR-AC4A0103TAA	Inverter A1000, 400 V, ND: 103 A / 55 kW, HD: 91 A / 45 kW, IP54 Wall Mount	8.602 EUR
CIMR-AC4A0139TAA	Inverter A1000, 400 V, ND: 139 A / 75 kW, HD: 112 A / 55 kW, IP54 Wall Mount	9.675 EUR
CIMR-AC4A0165TAA	Inverter A1000, 400 V, ND: 165 A / 90 kW, HD: 150 A / 75 kW, IP54 Wall Mount	11.084 EUR

## Inverter A1000 400 VAC Three Phase - IP54 Wall Mount with Main Switch

Ürün Kodu	Açıklama	Liste Fiyatı
CIMR-AC4A0044TAA-0095	Inverter A1000, 400 V, ND: 44 A / 22 kW, HD: 39 A / 18,5 kW, IP54 Wall Mount w Main Switch	4.377 EUR
CIMR-AC4A0058TAA-0095	Inverter A1000, 400 V, ND: 58 A / 30 kW, HD: 45 A / 22 kW, IP54 Wall Mount w Main Switch	5.426 EUR
CIMR-AC4A0072TAA-0095	Inverter A1000, 400 V, ND: 72 A / 37 kW, HD: 60 A / 30 kW, IP54 Wall Mount w Main Switch	6.735 EUR
CIMR-AC4A0088TAA-0095	Inverter A1000, 400 V, ND: 88 A / 45 kW, HD: 75 A / 37 kW, IP54 Wall Mount w Main Switch	8.956 EUR
CIMR-AC4A0103TAA-0095	Inverter A1000, 400 V, ND: 103 A / 55 kW, HD: 91 A / 45 kW, IP54 Wall Mount w Main Switch	9.730 EUR
CIMR-AC4A0139TAA-0095	Inverter A1000, 400 V, ND: 139 A / 75 kW, HD: 112 A / 55 kW, IP54 Wall Mount w Main Switch	10.751 EUR
CIMR-AC4A0165TAA-0095	Inverter A1000, 400 V, ND: 165 A / 90 kW, HD: 150 A / 75 kW, IP54 Wall Mount w Main Switch	12.195 EUR

## Inverter A1000 400 VAC Three Phase - IP54 Ready

Ürün Kodu	Açıklama	Liste Fiyatı
CIMR-AC4A0044WAA	Inverter A1000, 400 V, ND: 44 A / 22 kW, HD: 39 A / 18,5 kW, IP54 Ready	2.399 EUR
CIMR-AC4A0058WAA	Inverter A1000, 400 V, ND: 58 A / 30 kW, HD: 45 A / 22 kW, IP54 Ready	3.218 EUR
CIMR-AC4A0072WAA	Inverter A1000, 400 V, ND: 72 A / 37 kW, HD: 60 A / 30 kW, IP54 Ready	3.551 EUR
CIMR-AC4A0088WAA	Inverter A1000, 400 V, ND: 88 A / 45 kW, HD: 75 A / 37 kW, IP54 Ready	4.395 EUR
CIMR-AC4A0103WAA	Inverter A1000, 400 V, ND: 103 A / 55 kW, HD: 91 A / 45 kW, IP54 Ready	4.486 EUR
CIMR-AC4A0139WAA	Inverter A1000, 400 V, ND: 139 A / 75 kW, HD: 112 A / 55 kW, IP54 Ready	5.622 EUR
CIMR-AC4A0165WAA	Inverter A1000, 400 V, ND: 165 A / 90 kW, HD: 150 A / 75 kW, IP54 Ready	7.117 EUR

## EMC Line-Filters for A1000 400VAC (UL on request)

Ürün Kodu	Açıklama	Liste Fiyatı
FB-40008A	EMC Line-Filter for CIMR-AC4A0002 to 0007. EN61800-3 Class C1 (25m) C2 (50m), 8 Amp.	105 EUR
FB-40014A	EMC Line-Filter for CIMR-AC4A0009, 0011. EN61800-3 Class C1 (25m) C2 (50m), 14 Amp.	120 EUR
FB-40025A	EMC Line-Filter for CIMR-AC4A0018, 0023. EN61800-3 Class C1 (25m) C2 (50m), 25 Amp.	149 EUR
FB-40044A	EMC Line-Filter for CIMR-AC4A0031, 0038. EN61800-3 Class C1 (25m) C2 (50m), 44 Amp.	200 EUR
FB-40060A	EMC Line-Filter for CIMR-AC4A0044, 0058. EN61800-3 Class C1 (25m) C2 (50m), 60 Amp.	251 EUR
FB-40072A	EMC Line-Filter for CIMR-AC4A0072. EN61800-3 Class C2 (50m), 72 Amp.	340 EUR
FB-40105A	EMC Line-Filter for CIMR-AC4A0088, 0103. EN61800-3 Class C2 (50m), 105 Amp.	455 EUR
FB-40170A	EMC Line-Filter for CIMR-AC4A0139, 0165. EN61800-3 Class C2 (50m), 170 Amp.	696 EUR
FB-40250A	EMC Line-Filter for CIMR-AC4A0208, 0250. EN61800-3 Class C2 (50m), 250 Amp.	800 EUR
FB-40414A	EMC Line-Filter for CIMR-AC4A0296, 0362, 0414. EN61800-3 Class C2 (50m), 414 Amp.	1.107 EUR
FB-40675A	EMC Line-Filter for CIMR-AC4A0515, 0675. EN61800-3 Class C2 (50m), 675 Amp.	1.370 EUR
FB-41200A	EMC Line-Filter for CIMR-AC4A0930, 1200. EN61800-3 Class C2 (50m), 1200 Amp.	4.611 EUR

All filters below and incl. FB-40044A are footmount.

## IT Net-Filters for A1000 400VAC

Ürün Kodu	Açıklama	Liste Fiyatı
HLD 810-500/8	IT Net-Filter for CIMR-AC4A0002, 0004, 0005, 0007. EN61800-3 Class C3 (10m), 8 Amp.	151 EUR
HLD 810-500/16	IT Net-Filter for CIMR-AC4A0009, 0011. EN61800-3 Class C3 (10m), 16 Amp.	179 EUR
HLD 810-500/30	IT Net-Filter for CIMR-AC4A0018, 0023. EN61800-3 Class C3 (10m), 30 Amp.	256 EUR
HLD 810-500/42	IT Net-Filter for CIMR-AC4A0031. EN61800-3 Class C3 (10m), 42 Amp.	324 EUR
HLD 810-500/55	IT Net-Filter for CIMR-AC4A0038, 0044. EN61800-3 Class C3 (10m), 55 Amp.	369 EUR
HLD 810-500/75	IT Net-Filter for CIMR-AC4A0058, 0072. EN61800-3 Class C3 (10m), 75 Amp.	492 EUR
HLD 810-500/100	IT Net-Filter for CIMR-AC4A0088. EN61800-3 Class C3 (10m), 100 Amp.	677 EUR
HLD 810-500/130	IT Net-Filter for CIMR-AC4A0103. EN61800-3 Class C3 (10m), 130 Amp.	789 EUR
HLD 810-500/180	IT Net-Filter for CIMR-AC4A0139, 0165. EN61800-3 Class C3 (10m), 180 Amp.	1.088 EUR
HLD 810-500/250	IT Net-Filter for CIMR-AC4A0208, 0250. EN61800-3 Class C3 (10m), 250 Amp.	1.378 EUR
HLD 803-500/415	IT Net-Filter for CIMR-AC4A0296, 0362, 0414. EN61800-3 Class C3 (10m), 415 Amp.	1.740 EUR
HLD 803-500/675	IT Net-Filter for CIMR-AC4A0515, 0675. EN61800-3 Class C3 (10m), 675 Amp.	2.071 EUR

## Sinus Output-Filter IP00 for A1000 400VAC

Ürün Kodu	Açıklama	Liste Fiyatı
SR-40004A-00	Sinus Output Filter IP00 for CIMR-AC4A0002. 04 Amp., 0,90 kg copper	127 EUR
SR-40006A-00	Sinus Output Filter IP00 for CIMR-AC4A0004, 0005. 06 Amp., 1,10 kg copper	186 EUR
SR-40008A-00	Sinus Output Filter IP00 for CIMR-AC4A0007. 08 Amp., 1,20 kg copper	208 EUR
SR-40010A-00	Sinus Output Filter IP00 for CIMR-AC4A0009. 10 Amp., 1,90 kg copper	260 EUR
SR-40016A-00	Sinus Output Filter IP00 for CIMR-AC4A0011. 16 Amp., 3,20 kg copper	337 EUR
SR-40020A-00	Sinus Output Filter IP00 for CIMR-AC4A0018. 20 Amp., 3,30 kg copper	426 EUR
SR-40024A-00	Sinus Output Filter IP00 for CIMR-AC4A0023. 24 Amp., 3,60 kg copper	503 EUR
SR-40037A-00	Sinus Output Filter IP00 for CIMR-AC4A0031. 37 Amp., 9,90 kg copper	602 EUR
SR-40048A-00	Sinus Output Filter IP00 for CIMR-AC4A0038, 0044. 48 Amp., 10,50 kg copper	683 EUR
SR-40060A-00	Sinus Output Filter IP00 for CIMR-AC4A0058. 60 Amp., 11,50 kg copper	858 EUR
SR-40075A-00	Sinus Output Filter IP00 for CIMR-AC4A0072. 75 Amp., 16,50 kg copper	953 EUR
SR-40115A-00	Sinus Output Filter IP00 for CIMR-AC4A0088, 0103. 115 Amp., 2,0 kg copper	1.711 EUR
SR-40150A-00	Sinus Output Filter IP00 for CIMR-AC4A0139. 150 Amp., 2,0 kg copper	1.736 EUR
SR-40200A-00	Sinus Output Filter IP00 for CIMR-AC4A0165. 200 Amp., 2,0 kg copper	2.143 EUR
SR-40250A-00	Sinus Output Filter IP00 for CIMR-AC4A0208, 0250. 250 Amp., 2,0 kg copper	2.639 EUR
SR-40350A-00	Sinus Output Filter IP00 for CIMR-AC4A0296. 350 Amp., 3,0 kg copper	3.134 EUR
SR-40450A-00	Sinus Output Filter IP00 for CIMR-AC4A0362, 0414. 450 Amp., 4,0 kg copper	3.289 EUR
SR-40600A-00	Sinus Output Filter IP00 for CIMR-AC4A0515. 600 Amp., 5,0 kg copper	3.851 EUR
SR-40800A-00	Sinus Output Filter IP00 for CIMR-AC4A0675. 800 Amp., 6,0 kg copper	8.529 EUR
SR-41000A-00	Sinus Output Filter IP00 for CIMR-AC4A0930. 1000 Amp., 17,0 kg copper	11.293 EUR
SR-41200A-00	Sinus Output Filter IP00 for CIMR-AC4A1200. 1200 Amp., 18,0 kg copper	13.205 EUR

Please note that we will add a copper fee to the above mentioned products on our order confirmation. The basis for the copper price which we will invoice is available on: <http://www.lme.com/copper.asp>. We use the following formula for the copper surcharge:  $((3\text{-month buyer*exchange rate USD vs. EURO})/1000 \times \text{copper weight})$

Limitation: for Carrier Frequency 2 kHz - 8 kHz

## IP20 Box for Sinus Output-Filter

Ürün Kodu	Açıklama	Liste Fiyatı
IP20-Box06	IP20 Box for Sinus Output Filter SR-40004A-00 to SR-40010A-00	208 EUR
IP20-Box07	IP20 Box for Sinus Output Filter SR-40016A-00 to SR-40024A-00	222 EUR
IP20-Box08	IP20 Box for Sinus Output Filter SR-40037A-00 to SR-40060A-00	246 EUR
IP20-Box03	IP20 Box for Sinus Output Filter SR-40075A-00 to SR-40250A-00	415 EUR
IP20-Box04	IP20 Box for Sinus Output Filter SR-40350A-00 to SR-40600A-00	451 EUR
IP20-Box05	IP20 Box for Sinus Output Filter SR-40800A-00 to SR-41200A-00	545 EUR

## dV/dt Output-Filter IP00 for A1000 400VAC

Ürün Kodu	Açıklama	Liste Fiyatı
DB-40007A-IP00	For inverter models CIMR-AC4A0002, 0004, 0005, 0007. 7 Amp., 0,50 kg copper	274 EUR
DB-40024A-IP00	For inverter models CIMR-AC4A0009, 0011, 0018, 0023. 24 Amp., 1,60 kg copper	396 EUR
DB-40045A-IP00	For inverter models CIMR-AC4A0031, 0038, 0044, 0023. 45 Amp., 3,30 kg copper	611 EUR
DB-40075A-IP00	For inverter models CIMR-AC4A0058, 0072. 75 Amp., 4,50 kg copper	877 EUR
DB-40110A-IP00	For inverter models CIMR-AC4A0088, 0103. 110 Amp., 7,00 kg copper	1.099 EUR
DB-40182A-IP00	For inverter models CIMR-AC4A0139, 0165. 182 Amp., 10,3 kg copper	1.498 EUR
DB-40250A-IP00	For inverter models CIMR-AC4A0208, 0250. 250 Amp., 15,0 kg copper	1.628 EUR
DB-40296A-IP00	For inverter models CIMR-AC4A0296. 269 Amp., 20,0 kg copper	2.126 EUR
DB-40414A-IP00	For inverter models CIMR-AC4A0362, 0414. 414 Amp., 20,0 kg copper	3.112 EUR
DB-40675A-IP00	For inverter models CIMR-AC4A0515, 0675. 675 Amp., 37,7 kg copper	5.344 EUR

Please note that we will add a copper fee to the above mentioned products on our order confirmation. The basis for the copper price which we will invoice is

available on: <http://www.lme.com/copper.asp>. We use the following formula for the copper surcharge: ((3-month buyer\*exchange rate USD vs. EURO)/1000\*copper weight)

## IP20 Box for dV/dt Output-Filter

Ürün Kodu	Açıklama	Liste Fiyatı
IP20-Box31	IP20 Box for dV/dt Output Filter DB-40007A-IP00	57 EUR
IP20-Box32	IP20 Box for dV/dt Output Filter DB-40024A-IP00	60 EUR
IP20-Box35	IP20 Box for dV/dt Output Filter DB-40045A-IP00	70 EUR
IP20-Box36	IP20 Box for dV/dt Output Filter DB-40075A-IP00	74 EUR
IP20-Box39	IP20 Box for dV/dt Output Filter DB-40110A-IP00	137 EUR
IP20-Box41	IP20 Box for dV/dt Output Filter DB-40182A-IP00 to DB-40296A-IP00	158 EUR
IP20-Box45	IP20 Box for dV/dt Output Filter DB-40414A-IP00	238 EUR
IP20-Box41	IP20 Box for dV/dt Output Filter DB-40675A-IP00	158 EUR

## AC Input Reactors 4 % IP00 for A1000 400VAC

Ürün Kodu	Açıklama	Liste Fiyatı
LR3 40-4/2	AC Input Reactor 4% IP00 for CIMR-AC4A0002. 2 Amp., 0,12 kg copper	52 EUR
LR3 40-4/4	AC Input Reactor 4% IP00 for CIMR-AC4A0004. 4 Amp., 0,30 kg copper	57 EUR
LR3 40-4/6	AC Input Reactor 4% IP00 for CIMR-AC4A0005. 6 Amp., 0,31 kg copper	65 EUR
LR3 40-4/10	AC Input Reactor 4% IP00 for CIMR-AC4A0007, 0009. 10 Amp., 0,60 kg copper	84 EUR
LR3 40-4/16	AC Input Reactor 4% IP00 for CIMR-AC4A0011. 16 Amp., 0,67 kg copper	93 EUR
LR3 40-4/20	AC Input Reactor 4% IP00 for CIMR-AC4A0018. 20 Amp., 1,20 kg copper	113 EUR
LR3 40-4/25	AC Input Reactor 4% IP00 for CIMR-AC4A0023. 25 Amp., 1,52 kg copper	158 EUR
LR3 40-4/45	AC Input Reactor 4% IP00 for CIMR-AC4A0031, 0038. 45 Amp., 2,35 kg copper	222 EUR
LR3 40-4/63	AC Input Reactor 4% IP00 for CIMR-AC4A0044, 0058. 63 Amp., 2,71 kg copper	258 EUR
LR3 40-4/70	AC Input Reactor 4% IP00 for CIMR-AC4A0072. 70 Amp., 3,15 kg copper	315 EUR
LR3 40-4/90	AC Input Reactor 4% IP00 for CIMR-AC4A0088. 90 Amp., 5,50 kg copper	520 EUR
LR3 40-4/115	AC Input Reactor 4% IP00 for CIMR-AC4A0103. 115 Amp., 5,80 kg copper	685 EUR
LR3 40-4/160	AC Input Reactor 4% IP00 for CIMR-AC4A0139, 0165. 160 Amp., 8,85 kg copper	794 EUR
LR3 40-4/200	AC Input Reactor 4% IP00 for CIMR-AC4A0208. 200 Amp., 11,0 kg copper	842 EUR
LR3 40-4/250	AC Input Reactor 4% IP00 for CIMR-AC4A0250. 250 Amp., 14,5 kg copper	923 EUR
LR3 40-4/300	AC Input Reactor 4% IP00 for CIMR-AC4A0296. 300 Amp., 16,2 kg copper	1.134 EUR
LR3 40-4/400	AC Input Reactor 4% IP00 for CIMR-AC4A0362, 0414. 400 Amp., 18,0 kg copper	1.231 EUR
LR3 40-4/500	AC Input Reactor 4% IP00 for CIMR-AC4A0515. 500 Amp., 21,0 kg copper	1.347 EUR
LR3 40-4/710	AC Input Reactor 4% IP00 for CIMR-AC4A0675. 710 Amp., 36,4 kg copper	2.368 EUR
LR3 40-4/1200	AC Input Reactor 4% IP00 for CIMR-AC4A0930, 1200. 1200 Amp., 50,0 kg copper	5.779 EUR

Please note that we will add a copper fee to the above mentioned products on our order confirmation. The basis for the copper price which we will invoice is

available on: <http://www.lme.com/copper.asp>. We use the following formula for the copper surcharge: ((3-month buyer\*exchange rate USD vs. EURO)/1000\*copper weight)

## IP20 Box for AC Input Reactors 4 %

Ürün Kodu	Açıklama	Liste Fiyatı
IP20-Box31	IP20 Box for AC input reactor type LR3 40-4/2	57 EUR
IP20-Box32	IP20 Box for AC input reactor type LR3 40-4/4 to LR3 40-4/20	60 EUR
IP20-Box33	IP20 Box for AC input reactor type LR3 40-4/25	62 EUR
IP20-Box35	IP20 Box for AC input reactor type LR3 40-4/45	70 EUR
IP20-Box36	IP20 Box for AC input reactor type LR3 40-4/63	74 EUR
IP20-Box37	IP20 Box for AC input reactor type LR3 40-4/70	81 EUR
IP20-Box39	IP20 Box for AC input reactor type LR3 40-4/90	137 EUR
IP20-Box41	IP20 Box for AC input reactor type LR3 40-4/115 to LR3 40-4/200	158 EUR
IP20-Box44	IP20 Box for AC input reactor type LR3 40-4/250 to LR3 40-4/400	222 EUR
IP20-Box45	IP20 Box for AC input reactor type LR3 40-4/500	238 EUR
IP20-Box46	IP20 Box for AC input reactor type LR3 40-4/710 to LR3 40-4/1200	253 EUR

## AC Input Reactors IP00 2 % for A1000 400VAC

Ürün Kodu	Açıklama	Liste Fiyatı
ALR3 40-2/2	AC Input Reactor 2% IP00 for CIMR-AC4A0002. 2 Amp., 0,10 kg copper	53 EUR
ALR3 40-2/4	AC Input Reactor 2% IP00 for CIMR-AC4A0004. 4 Amp., 0,15 kg copper	53 EUR
ALR3 40-2/6	AC Input Reactor 2% IP00 for CIMR-AC4A0005. 6 Amp., 0,25 kg copper	57 EUR
ALR3 40-2/10	AC Input Reactor 2% IP00 for CIMR-AC4A0007, 0009. 10 Amp., 0,30 kg copper	69 EUR
ALR3 40-2/16	AC Input Reactor 2% IP00 for CIMR-AC4A0011. 16 Amp., 0,50 kg copper	77 EUR
ALR3 40-2/20	AC Input Reactor 2% IP00 for CIMR-AC4A0018. 20 Amp., 0,60 kg copper	77 EUR
ALR3 40-2/25	AC Input Reactor 2% IP00 for CIMR-AC4A0023. 25 Amp., 0,80 kg copper	88 EUR
ALR3 40-2/45	AC Input Reactor 2% IP00 for CIMR-AC4A0031, 0038. 45 Amp., 1,40 kg copper	116 EUR
ALR3 40-2/63	AC Input Reactor 2% IP00 for CIMR-AC4A0044, 0058. 63 Amp., 2,30 kg copper	194 EUR

Please note that we will add a copper fee to the above mentioned products on our order confirmation. The basis for the copper price which we will invoice is available on: <http://www.lme.com/copper.asp>. We use the following formula for the copper surcharge: ((3-month buyer\*exchange rate USD vs. EURO)/1000\*copper weight)

## IP20 Box for AC Input Reactors 2 %

Ürün Kodu	Açıklama	Liste Fiyatı
IP20-Box31	IP20 Box for AC input reactor type ALR3 40-4/2 to ALR3 40-4/6	57 EUR
IP20-Box32	IP20 Box for AC input reactor type ALR3 40-4/10 to ALR3 40-4/45	60 EUR
IP20-Box35	IP20 Box for AC input reactor type ALR3 40-4/63	70 EUR

## Harmonic Filters (THD-I < 5%) IP00 for A1000 400VAC

Ürün Kodu	Açıklama	Liste Fiyatı
HFM-FB 7-400	Harmonic Filter (THD-I < 5%) IP00, 10 Amp., 3,50 kg copper, for CIMR-AC4A0002 to 0009	2.238 EUR
HFM-FB 13-400	Harmonic Filter (THD-I < 5%) IP00, 19 Amp., 4,50 kg copper, for CIMR-AC4A0011, 0018	2.617 EUR
HFM-FB 18-400	Harmonic Filter (THD-I < 5%) IP00, 26 Amp., 7,00 kg copper, for CIMR-AC4A0023	3.571 EUR
HFM-FB 30-400	Harmonic Filter (THD-I < 5%) IP00, 43 Amp., 11,5 kg copper, for CIMR-AC4A0031, 0038	5.102 EUR
HFM-FB 50-400	Harmonic Filter (THD-I < 5%) IP00, 72 Amp., 18,0 kg copper, for CIMR-AC4A0044, 0058, 0072	6.737 EUR
HR-40110A-00	Harmonic Filter (THD-I < 5%) IP00, 110 Amp., 9,00 kg copper, for CIMR-AC4A0088 to 0103	6.111 EUR
HR-40180A-00	Harmonic Filter (THD-I < 5%) IP00, 180 Amp., 12,0 kg copper, for CIMR-AC4A0139	7.322 EUR
HR-40200A-00	Harmonic Filter (THD-I < 5%) IP00, 200 Amp., 13,0 kg copper, for CIMR-AC4A0165	7.639 EUR
HR-40230A-00	Harmonic Filter (THD-I < 5%) IP00, 230 Amp., 4,00 kg copper, for CIMR-AC4A0208	8.538 EUR
HR-40270A-00	Harmonic Filter (THD-I < 5%) IP00, 270 Amp., 4,00 kg copper, for CIMR-AC4A0250	9.434 EUR
HR-40330A-00	Harmonic Filter (THD-I < 5%) IP00, 330 Amp., 4,00 kg copper, for CIMR-AC4A0296	10.109 EUR
HR-40400A-00	Harmonic Filter (THD-I < 5%) IP00, 400 Amp., 7,00 kg copper, for CIMR-AC4A0362	16.747 EUR
HR-40450A-00	Harmonic Filter (THD-I < 5%) IP00, 450 Amp., 8,00 kg copper, for CIMR-AC4A0414	18.064 EUR
HR-40550A-00	Harmonic Filter (THD-I < 5%) IP00, 550 Amp., 9,00 kg copper, for CIMR-AC4A0515	19.497 EUR
HR-40800A-00	Harmonic Filter (THD-I < 5%) IP00, 800 Amp., 17,0 kg copper, for CIMR-AC4A0675	25.816 EUR
HR-41000A-00	Harmonic Filter (THD-I < 5%) IP00, 1.000 Amp., 21,0 kg copper, for CIMR-AC4A0930	30.708 EUR
HR-41200A-00	Harmonic Filter (THD-I < 5%) IP00, 1.200 Amp., 24,0 kg copper, for CIMR-AC4A1200	35.381 EUR

Please note that we will add a copper fee to the above mentioned products on our order confirmation. The basis for the copper price which we will invoice is available on: <http://www.lme.com/copper.asp>. We use the following formula for the copper surcharge: ((3-month buyer\*exchange rate USD vs. EURO)/1000\*copper weight)

IP20 Filters are available on request. Please contact your local Yaskawa representative for further information.

## AC Output Reactors IP00 for A1000 400VAC (up to 120 Hz Output Frequency)

Ürün Kodu	Açıklama	Liste Fiyatı
MDB 400/6,3	AC Output Reactor IP00 up to 120 Hz Output Frequency for CIMR-AC4A0002, 0004, 0005. 6,3 Amp., 0,70 kg copper	204 EUR
MDB 400/13	AC Output Reactor IP00 up to 120 Hz Output Frequency for CIMR-AC4A0007, 0009. 13 Amp., 0,90 kg copper	236 EUR
MDB 400/24	AC Output Reactor IP00 up to 120 Hz Output Frequency for CIMR-AC4A0011, 0018, 0023*. 24 Amp., 1,30 kg copper	371 EUR
MDB 400/46	AC Output Reactor IP00 up to 120 Hz Output Frequency for CIMR-AC4A0023*, 0031, 0038. 46 Amp., 1,70 kg copper	452 EUR
MDB 400/72	AC Output Reactor IP00 up to 120 Hz Output Frequency for CIMR-AC4A0044, 0058, 0072. 72 Amp., 1,30 kg copper	452 EUR
MDB 400/110	AC Output Reactor IP00 up to 120 Hz Output Frequency for CIMR-AC4A0088, 0103. 110 Amp., 3,40 kg copper	699 EUR
MDB 400/176	AC Output Reactor IP00 up to 120 Hz Output Frequency for CIMR-AC4A0139, 0165. 176 Amp., 7,60 kg copper	1.045 EUR
MDB 400/250	AC Output Reactor IP00 up to 120 Hz Output Frequency for CIMR-AC4A0208, 0250. 250 Amp., 4,50 kg copper	1.061 EUR
MDB 400/380	AC Output Reactor IP00 up to 120 Hz Output Frequency for CIMR-AC4A0296, 0362. 380 Amp., 9,5 kg copper	1.307 EUR
MDB 400/430	AC Output Reactor IP00 up to 120 Hz Output Frequency for CIMR-AC4A0414. 430 Amp., 14,5 kg copper	1.782 EUR
MDB 400/700	AC Output Reactor IP00 up to 120 Hz Output Frequency for CIMR-AC4A0515, 0675. 700 Amp., 42,0 kg copper	3.875 EUR
MDB 400/1200	AC Output Reactor IP00 up to 120 Hz Output Frequency for CIMR-AC4A0930, 1200. 1200 Amp., 21,0 kg copper	4.041 EUR

Please note that we will add a copper fee to the above mentioned products on our order confirmation. The basis for the copper price which we will invoice is available on: <http://www.lme.com/copper.asp>. We use the following formula for the copper surcharge: ((3-month buyer\*exchange rate USD vs. EURO)/1000\*copper weight)

\* When you are using 8 kHz choose MDB 400/46.

## IP20 Box for AC Output Reactors IP00 (up to 120 Hz Output Frequency)

Ürün Kodu	Açıklama	Liste Fiyatı
IP20-Box31	IP20 Box for AC Output Reactor MDB 400/6,3	57 EUR
IP20-Box32	IP20 Box for AC Output Reactor MDB 400/13	60 EUR
IP20-Box36	IP20 Box for AC Output Reactor MDB 400/24	74 EUR
IP20-Box37	IP20 Box for AC Output Reactor MDB 400/46 to MDB 400/72	81 EUR
IP20-Box39	IP20 Box for AC Output Reactor MDB 400/110	137 EUR
IP20-Box41	IP20 Box for AC Output Reactor MDB 400/176 to MDB 400/380	158 EUR
IP20-Box44	IP20 Box for AC Output Reactor MDB 400/430	222 EUR
IP20-Box45	IP20 Box for AC Output Reactor MDB 400/700	238 EUR
IP20-Box46	IP20 Box for AC Output Reactor MDB 400/1200	253 EUR

## AC Output Reactors IP00 for A1000 400VAC (up to 50 Hz Output Frequency)

Ürün Kodu	Açıklama	Liste Fiyatı
MR3 400/4	AC Output Reactor IP00 up to 50 Hz Output Frequency for CIMR-AC4A0002. 4 Amp., 0,10 kg copper	92 EUR
MR3 400/10	AC Output Reactor IP00 up to 50 Hz Output Frequency for CIMR-AC4A0004, 0005, 0007, 0009. 10 Amp., 0,20 kg copper	117 EUR
MR3 400/18	AC Output Reactor IP00 up to 50 Hz Output Frequency for CIMR-AC4A0011. 18 Amp., 0,40 kg copper	143 EUR
MR3 400/24	AC Output Reactor IP00 up to 50 Hz Output Frequency for CIMR-AC4A0018, 0023*. 24 Amp., 0,50 kg copper	164 EUR
MR3 400/37	AC Output Reactor IP00 up to 50 Hz Output Frequency for CIMR-AC4A0023*. 37 Amp., 0,70 kg copper	207 EUR
MR3 400/48	AC Output Reactor IP00 up to 50 Hz Output Frequency for CIMR-AC4A0031, 0038. 48 Amp., 1,10 kg copper	280 EUR
MR3 400/61	AC Output Reactor IP00 up to 50 Hz Output Frequency for CIMR-AC4A0044, 0058. 61 Amp., 1,50 kg copper	387 EUR

Please note that we will add a copper fee to the above mentioned products on our order confirmation. The basis for the copper price which we will invoice is available on: <http://www.lme.com/copper.asp>. We use the following formular for the copper surcharge: ((3-month buyer\*exchange rate USD vs. EURO)/1000\*copper weight)

\* When you are using 8 kHz choose MR3 400/37.

## IP20 Box for AC Output Reactors IP00 (up to 50 Hz Output Frequency)

Ürün Kodu	Açıklama	Liste Fiyatı
IP20-Box31	IP20 Box for AC Output Reactor MR3 400/4	57 EUR
IP20-Box32	IP20 Box for AC Output Reactor MR3 400/10 to MR3 400/24	60 EUR
IP20-Box33	IP20 Box for AC Output Reactor MR3 400/37	62 EUR
IP20-Box35	IP20 Box for AC Output Reactor MR3 400/48 to MR3 400/61	70 EUR

## Inverter A1000 200 VAC Three Phase - IP00 / NEMA1

Ürün Kodu	Açıklama	Liste Fiyatı
CIMR-AC2A0004FAA	Inverter A1000, 200 V, ND: 3,5 A / 0,75 kW, HD: 3,2 A / 0,55 kW, NEMA1	790 EUR
CIMR-AC2A0006FAA	Inverter A1000, 200 V, ND: 6 A / 1,1 kW, HD: 5 A / 0,75 kW, NEMA1	891 EUR
CIMR-AC2A0010FAA	Inverter A1000, 200 V, ND: 9,6 A / 2,2 kW, HD: 8 A / 1,5 kW, NEMA1	1.019 EUR
CIMR-AC2A0012FAA	Inverter A1000, 200 V, ND: 12 A / 3 kW, HD: 11 A / 2,2 kW, NEMA1	1.114 EUR
CIMR-AC2A0021FAA	Inverter A1000, 200 V, ND: 21 A / 5,5 kW, HD: 17,5 A / 4 kW, NEMA1	1.231 EUR
CIMR-AC2A0030FAA	Inverter A1000, 200 V, ND: 30 A / 7,5 kW, HD: 25 A / 5,5 kW, NEMA1	1.543 EUR
CIMR-AC2A0040FAA	Inverter A1000, 200 V, ND: 40 A / 11 kW, HD: 33 A / 7,5 kW, NEMA1	1.805 EUR
CIMR-AC2A0056FAA	Inverter A1000, 200 V, ND: 56 A / 15 kW, HD: 47 A / 11 kW, NEMA1	2.289 EUR
CIMR-AC2A0069FAA	Inverter A1000, 200 V, ND: 69 A / 18,5 kW, HD: 60 A / 15 kW, NEMA1	3.203 EUR
CIMR-AC2A0081FAA	Inverter A1000, 200 V, ND: 81 A / 22 kW, HD: 75 A / 18,5 kW, NEMA1	4.693 EUR
CIMR-AC2A0110AAA	Inverter A1000, 200 V, ND: 110 A / 30 kW, HD: 85 A / 22 kW, IP00	5.163 EUR
CIMR-AC2A0138AAA	Inverter A1000, 200 V, ND: 138 A / 37 kW, HD: 115 A / 30 kW, IP00	5.508 EUR
CIMR-AC2A0169AAA	Inverter A1000, 200 V, ND: 169 A / 45 kW, HD: 145 A / 37 kW, IP00	6.739 EUR
CIMR-AC2A0211AAA	Inverter A1000, 200 V, ND: 211 A / 55 kW, HD: 180 A / 45 kW, IP00	7.430 EUR
CIMR-AC2A0250AAA	Inverter A1000, 200 V, ND: 250 A / 75 kW, HD: 215 A / 55 kW, IP00	8.896 EUR
CIMR-AC2A0312AAA	Inverter A1000, 200 V, ND: 312 A / 90 kW, HD: 283 A / 75 kW, IP00	15.970 EUR
CIMR-AC2A0360AAA	Inverter A1000, 200 V, ND: 360 A / 110 kW, HD: 346 A / 90 kW, IP00	17.928 EUR
CIMR-AC2A0415AAA	Inverter A1000, 200 V, ND: 415 A / 110 kW, HD: 415 A / 110 kW, IP00	20.023 EUR

## EMC Line-Filters for A1000 200VAC (UL on request)

Ürün Kodu	Açıklama	Liste Fiyatı
FB-40008A	EMC Line-Filter for CIMR-AC2A0004, 0006. EN61800-3 Class C1 (25m) C2 (50m), 8 Amp.	105 EUR
FB-40014A	EMC Line-Filter for CIMR-AC2A0010, 0012. EN61800-3 Class C1 (25m) C2 (50m), 14 Amp.	120 EUR
FB-40025A	EMC Line-Filter for CIMR-AC2A0021. EN61800-3 Class C1 (25m) C2 (50m), 25 Amp.	149 EUR
FB-40060A	EMC Line-Filter for CIMR-AC4A0030, 0040, 0056. EN61800-3 Class C1 (25m) C2 (50m), 60 Amp.	251 EUR
FB-40072A	EMC Line-Filter for CIMR-AC2A0069. EN61800-3 Class C2 (50m), 72 Amp.	340 EUR
FB-40105A	EMC Line-Filter for CIMR-AC2A0081, 0110, 0138. EN61800-3 Class C2 (50m), 105 Amp.	455 EUR
FB-40170A	EMC Line-Filter for CIMR-AC2A0169. EN61800-3 Class C2 (50m), 170 Amp.	696 EUR
FB-40250A	EMC Line-Filter for CIMR-AC2A0211, 0250, 0312. EN61800-3 Class C2 (50m), 250 Amp.	800 EUR
FB-40414A	EMC Line-Filter for CIMR-AC2A0360. EN61800-3 Class C2 (50m), 414 Amp.	1.107 EUR
FB-40675A	EMC Line-Filter for CIMR-AC2A0415. EN61800-3 Class C2 (50m), 675 Amp.	1.370 EUR

All filters below incl. FB-40044A are footmount.

## Additional available software for A1000

Ürün Kodu	Açıklama	Liste Fiyatı
A1000 Winder Software	200 V Three-Phase 0.4 to 110 kW, 400 V Three-Phase 0.4 to 300 kW	Sorunuz
A1000 ELS Software (Electronic Line Shaft Software)	200 V Three-Phase 0.4 to 110 kW, 400 V Three-Phase 0.4 to 300 kW	Sorunuz
A1000 Positioning Software	200 V Three-Phase 0.4 to 110 kW, 400 V Three-Phase 0.4 to 300 kW	Sorunuz

For these software types please get in touch with your Yaskawa contact person.

## Options for A1000 Series

Ürün Kodu	Açıklama	Liste Fiyatı
EZZ021136A	NEMA1 Kit for Inverter A1000, T1000A 200V 110A	281 EUR
EZZ021136B	NEMA1 Kit for Inverter A1000, T1000A 200V 138A	310 EUR
EZZ021136C	NEMA1 Kit for Inverter A1000, T1000A 200V 169A, 211A - 400V 139A, 165A	327 EUR
EZZ021136D	NEMA1 Kit for Inverter A1000, T1000A 200V 250A, 312A - 400V 208A	523 EUR
EZZ021136E	NEMA1 Kit for Inverter A1000, T1000A 200V 360A - 400V 250A, 296A, 362A	640 EUR
EZZ021136F	NEMA1 Kit for Inverter A1000, T1000A 400V 58A	560 EUR
EZZ021136G	NEMA1 Kit for Inverter A1000, T1000A 400V 72A	270 EUR
EZZ021136H	NEMA1 Kit for Inverter A1000, T1000A 400V 88A, 103A	270 EUR
AI-A3	Analog Input card (3 inputs)	179 EUR
AO-A3	2 additional Analog Output	133 EUR
CDBR-2022D	200V Braking Transistor Unit 22kW	561 EUR
CDBR-2037D	200V Braking Transistor Unit 37kW	843 EUR
CDBR-2055D	200V Braking Transistor Unit 37kW	1.715 EUR
CDBR-2110D	200V Braking Transistor Unit 110kW	1.968 EUR
CDBR-4045D	400V Braking Transistor Unit 45kW	575 EUR
CDBR-4090D	400V Braking Transistor Unit 90kW	1.803 EUR
CDBR-4220D	400V Braking Transistor Unit 220kW	2.302 EUR
DI-A3	Digital Input (BCD Code)	109 EUR
DO-A3	Digital Output (6 open collector 2 relays)	109 EUR
EUOP-V11001	IP54/65 Operator Frame	25 EUR
EZZ020642A	Operator Attachment IP 20 with screws	24 EUR
EZZ020642B	Operator Attachment IP 20 with nuts	18 EUR
EZZ020800A	Heatsink external Attachment A1000 200V 4A, 6A,8A, 10A, 12A - 400V 2A, 4A, 5A	70 EUR
EZZ020800B	Heatsink external Attachment A1000 200V 18A, 21A, 30A, 40A - 400V 7A, 9A,11A, 18A, 23A	70 EUR
EZZ020800C	Heatsink external Attachment A1000 200V 56A - 400V 31A, 38A	77 EUR
EZZ020800D	Heatsink external Attachment A1000 200V 69A, 81A - 400V 44A	83 EUR
EZZ021710A	Retrofit Attachment for CDBR-2022D, 2037D, 4030D, 4045D	36 EUR
EZZ021711A	External Heatsink Attachment for CDBR-2037D, 4045D, 5037D	45 EUR
JVOP-180	LCD Operator 1000 Series (standard in A1000 included)	133 EUR
JVOP-181	Copy unit w/USB converter	232 EUR
JVOP-182	LED Operator 1000 Series	63 EUR
MANUAL	Technical Manual - Printed Version - for A1000 Series	64 EUR
PG-B3	Open Collector PG-Interface Card 50kHz	104 EUR
PG-X3	Line Driver PG-Interface Card 300kHz	104 EUR
PG-RT3	TS2640N321E64 PG-Interface Card	355 EUR
PS-A10HB	Power Supply Unit 24VDC (400V)	187 EUR
PS-A10LB	Power Supply Unit 24VDC (200V)	187 EUR
SI-C3	Comm. Interface A1000 CCLink	259 EUR
SI-EL3	Comm. Interface A1000 Powerlink	558 EUR
SI-EN3	Comm.Interface A1000 EtherNet IP	333 EUR
SI-EN3D	Comm. Interface A1000 Dual Port EtherNet IP	455 EUR
SI-EM3	Comm.Interface A1000 Modbus TCP	356 EUR
SI-EM3D	Comm.Interface A1000 Dual Port Modbus TCP	534 EUR
SI-EP3	Comm.Interface A1000 ProfiNet	498 EUR
EUOP-SI-ES3	Comm. Interface A1000 EtherCAT	351 EUR
SI-ES3	Comm. Interface A1000 EtherCAT *1	357 EUR
SI-N3	Comm. Interface A1000 DeviceNET	169 EUR
SI-P3	Comm. Interface A1000 ProfibusDP	361 EUR
SI-S3	Comm. Interface A1000 CANopen	187 EUR
SI-T3	Comm. Interface A1000 Mechatrolink II	242 EUR
SI-ET3	Comm. Interface A1000 Mechatrolink III	291 EUR
WV001-YEG	1m extension cable for remote Digital Operator	51 EUR
WV003-YEG	3m extension cable for remote Digital Operator	60 EUR

\*1: Note: The SI-ES option card will replace the EUOP-SI-ES3 card. Both cards will be available in parallel for a certain period of time. On the SI-ES3 card a few functions work in a different way than on the EUOP-SI-ES3 card. Therefore we recommend:

- not to mix SI-ES3 and EUOP-SI-ES3 cards in one project.
- use the SI-ES3, NOT EUOP-SI-ES3 for new projects.

Information on compatibility can be obtained from our technical support.





## **Basic Specification (like A1000 Std)**

### **Available Product Range:**

- 208 Amp Units
- 250 Amp Units
- 296 Amp Units
- 362 Amp Units
- 414 Amp Units
- 515 Amp Units
- 675 Amp Units

### **Input:**

Input Voltage: 380~480 Vac  
Allowable voltage fluctuation: +10/-15%  
Frequency: 50/60 Hz  
Frequency fluctuation: +-5%

### **Output:**

Max. Output Frequency: 0 to 400 Hz  
Overload Capability: 150% of rated current for 60 s

### **Control I/O:**

Digital Inputs: 8, PNP/NPN (Sink/Source) switchable, default: Sink  
Digital Outputs: 1 Fault, 3 Multi-function relays,  
Analog Inputs: 2 x -10 to +10V, 11 Bit + Sign, 1 x -10 to +10V / 0 to 20 mA, Input 3 switchable as PTC input  
Pulse Input: 1 x 0 to 24V, max. 32 kHz  
Analog Outputs: 2 x -10 to +10V, 10 Bit + Sign, 4 to 20 mA selectable by Jumper  
Pulse Output: 1 x, max. 32 kHz  
Safety: 2 x Safe Disable input, STO according to ISO13849, Pld, IEC61508, SIL2  
1 x EDM output (no TUV approval), used for stirring fan lock sensor by default  
Communications: RS-422/485, Memobus protocol

### **User interface:**

- Clear text LCD operator panel JVOP-180 mounted on panel door (standard)

### **Ambient Conditions:**

Storage temperature: -20 to +60 °C  
Ambient temperature: 0 to +40 °C  
Humidity: 95% RH or less  
Vibration:  
10 to 20 Hz at 9.8 m/s<sup>2</sup>, 20 to 55 Hz at 5.9 m/s<sup>2</sup>

### **Options:**

- IP23 or IP54 panel
- EMC filter standard/IT grid
- Mains Switch with or without door handle
- Input fuses or circuit breaker
- Extension bay left or right for optional components
  - Output reactor or dV/dt filter
  - Braking choppers

## Some A1000 FS sample configurations

### Inverter A1000 400 VAC Three Phase - FS, IP23, EMC Filter

Ürün Kodu	Açıklama	Liste Fiyatı
A140208A0A0A00000	Inverter A1000 FS 400V IP23 ND 208A 110kW, HD 180A 90kW , EMC Filter	20.908 EUR
A140250A0A0A00000	Inverter A1000 FS 400V IP23 ND 250A 132kW, HD 216A 110kW , EMC Filter	22.515 EUR
A140296A0A0A00000	Inverter A1000 FS 400V IP23 ND 296A 160kW, HD 260A 132kW , EMC Filter	25.266 EUR
A140362A0A0A00000	Inverter A1000 FS 400V IP23 ND 362A 185kW, HD 304A 160kW , EMC Filter	25.988 EUR
A140414A0A0A00000	Inverter A1000 FS 400V IP23 ND 414A 220kW, HD 370A 185kW , EMC Filter	34.287 EUR
A140515A0A0A00000	Inverter A1000 FS 400V IP23 ND 515A 250kW, HD 450A 220kW , EMC Filter	46.009 EUR
A140675A0A0A00000	Inverter A1000 FS 400V IP23 ND 675A 355kW, HD 605A 315kW , EMC Filter	52.873 EUR

### Inverter A1000 400 VAC Three Phase - FS, IP23, EMC Filter, Rotary mains switch with door handle

Ürün Kodu	Açıklama	Liste Fiyatı
A140208A0AFA00000	Inverter A1000 FS 400V IP23 ND 208A 110kW, HD 180A 90kW , EMC Filter, Rotary mains switch with door handle	21.452 EUR
A140250A0AFA00000	Inverter A1000 FS 400V IP23 ND 250A 132kW, HD 216A 110kW , EMC Filter, Rotary mains switch with door handle	23.062 EUR
A140296A0AFA00000	Inverter A1000 FS 400V IP23 ND 296A 160kW, HD 260A 132kW , EMC Filter, Rotary mains switch with door handle	26.090 EUR
A140362A0AFA00000	Inverter A1000 FS 400V IP23 ND 362A 185kW, HD 304A 160kW , EMC Filter, Rotary mains switch with door handle	26.812 EUR
A140414A0AFA00000	Inverter A1000 FS 400V IP23 ND 414A 220kW, HD 370A 185kW , EMC Filter, Rotary mains switch with door handle	35.313 EUR
A140515A0AFA00000	Inverter A1000 FS 400V IP23 ND 515A 250kW, HD 450A 220kW , EMC Filter, Rotary mains switch with door handle	47.035 EUR
A140675A0AFA00000	Inverter A1000 FS 400V IP23 ND 675A 355kW, HD 605A 315kW , EMC Filter, Rotary mains switch with door handle	55.356 EUR

### Inverter A1000 400 VAC Three Phase - FS, IP23, EMC Filter, Rotary mains switch with door handle, Circuit breaker

Ürün Kodu	Açıklama	Liste Fiyatı
A140208A0ACA00000	Inverter A1000 FS 400V IP23 ND 208A 110kW, HD 180A 90kW , EMC Filter, Rotary mains switch with door handle, Circuit breaker	23.872 EUR
A140250A0ACA00000	Inverter A1000 FS 400V IP23 ND 250A 132kW, HD 216A 110kW , EMC Filter, Rotary mains switch with door handle, Circuit breaker	25.483 EUR
A140296A0ACA00000	Inverter A1000 FS 400V IP23 ND 296A 160kW, HD 260A 132kW , EMC Filter, Rotary mains switch with door handle, Circuit breaker	28.509 EUR
A140362A0ACA00000	Inverter A1000 FS 400V IP23 ND 362A 185kW, HD 304A 160kW , EMC Filter, Rotary mains switch with door handle, Circuit breaker	29.233 EUR
A140414A0ACA00000	Inverter A1000 FS 400V IP23 ND 414A 220kW, HD 370A 185kW , EMC Filter, Rotary mains switch with door handle, Circuit breaker	38.509 EUR
A140515A0ACA00000	Inverter A1000 FS 400V IP23 ND 515A 250kW, HD 450A 220kW , EMC Filter, Rotary mains switch with door handle, Circuit breaker	50.231 EUR
A140675A0ACA00000	Inverter A1000 FS 400V IP23 ND 675A 355kW, HD 605A 315kW , EMC Filter, Rotary mains switch with door handle, Circuit breaker	59.804 EUR

### Inverter A1000 400 VAC Three Phase - FS, IP54, EMC Filter

Ürün Kodu	Açıklama	Liste Fiyatı
A140208K0A0A00000	Inverter A1000 FS 400V IP54 ND 208A 110kW, HD 180A 90kW , EMC Filter	21.830 EUR
A140250K0A0A00000	Inverter A1000 FS 400V IP54 ND 250A 132kW, HD 216A 110kW , EMC Filter	23.444 EUR
A140296K0A0A00000	Inverter A1000 FS 400V IP54 ND 296A 160kW, HD 260A 132kW , EMC Filter	26.258 EUR
A140362K0A0A00000	Inverter A1000 FS 400V IP54 ND 362A 185kW, HD 304A 160kW , EMC Filter	26.992 EUR
A140414K0A0A00000	Inverter A1000 FS 400V IP54 ND 414A 220kW, HD 370A 185kW , EMC Filter	35.643 EUR
A140515K0A0A00000	Inverter A1000 FS 400V IP54 ND 515A 250kW, HD 450A 220kW , EMC Filter	47.275 EUR
A140675K0A0A00000	Inverter A1000 FS 400V IP54 ND 675A 355kW, HD 605A 315kW , EMC Filter	59.394 EUR

## Inverter A1000 400 VAC Three Phase - FS, IP54, EMC Filter, Rotary mains switch with door handle

Ürün Kodu	Açıklama	Liste Fiyatı
A140208K0AFA00000	Inverter A1000 FS 400V IP54 ND 208A 110kW, HD 180A 90kW , EMC Filter, Rotary mains switch with door handle	28.404 EUR
A140250K0AFA00000	Inverter A1000 FS 400V IP54 ND 250A 132kW, HD 216A 110kW , EMC Filter, Rotary mains switch with door handle	23.991 EUR
A140296K0AFA00000	Inverter A1000 FS 400V IP54 ND 296A 160kW, HD 260A 132kW , EMC Filter, Rotary mains switch with door handle	27.082 EUR
A140362K0AFA00000	Inverter A1000 FS 400V IP54 ND 362A 185kW, HD 304A 160kW , EMC Filter, Rotary mains switch with door handle	27.817 EUR
A140414K0AFA00000	Inverter A1000 FS 400V IP54 ND 414A 220kW, HD 370A 185kW , EMC Filter, Rotary mains switch with door handle	36.670 EUR
A140515K0AFA00000	Inverter A1000 FS 400V IP54 ND 515A 250kW, HD 450A 220kW , EMC Filter, Rotary mains switch with door handle	48.302 EUR
A140675K0AFA00000	Inverter A1000 FS 400V IP54 ND 675A 355kW, HD 605A 315kW , EMC Filter, Rotary mains switch with door handle	59.394 EUR

## Inverter A1000 400 VAC Three Phase - FS, IP54, EMC Filter, Rotary mains switch with door handle, Circuit breaker

Ürün Kodu	Açıklama	Liste Fiyatı
A140208K0ACA00000	Inverter A1000 FS 400V IP54 ND 208A 110kW, HD 180A 90kW , EMC Filter, Rotary mains switch with door handle, Circuit breaker	24.797 EUR
A140250K0ACA00000	Inverter A1000 FS 400V IP54 ND 250A 132kW, HD 216A 110kW , EMC Filter, Rotary mains switch with door handle, Circuit breaker	26.412 EUR
A140296K0ACA00000	Inverter A1000 FS 400V IP54 ND 296A 160kW, HD 260A 132kW , EMC Filter, Rotary mains switch with door handle, Circuit breaker	29.503 EUR
A140362K0ACA00000	Inverter A1000 FS 400V IP54 ND 362A 185kW, HD 304A 160kW , EMC Filter, Rotary mains switch with door handle, Circuit breaker	30.233 EUR
A140414K0ACA00000	Inverter A1000 FS 400V IP54 ND 414A 220kW, HD 370A 185kW , EMC Filter, Rotary mains switch with door handle, Circuit breaker	39.865 EUR
A140515K0ACA00000	Inverter A1000 FS 400V IP54 ND 515A 250kW, HD 450A 220kW , EMC Filter, Rotary mains switch with door handle, Circuit breaker	51.498 EUR
A140675K0ACA00000	Inverter A1000 FS 400V IP54 ND 675A 355kW, HD 605A 315kW , EMC Filter, Rotary mains switch with door handle, Circuit breaker	63.842 EUR



## T1000A Inverter

- @ 0,4 - 185kW
- @ 200VAC & 400VAC
- @ 8 dig. Input / 1 Pulse Input / 2 Safety Inputs
- @ 1 Pulse Output / 1 Analog Output / 1 Relay Output / 2 Photocoupler Output
- @ V/f / Open Loop Vector / Advanced Open Loop Vector / Closed Loop Vector all for IM (Vector for PM), IM PM-, (SPM-, & IPM) motor control
- @ SAFETY EN 61508 SIL2, ISO 13849-1 PLd,

### Inverter T1000A 400 VAC Three Phase - IP20

Ürün Kodu	Açıklama	Liste Fiyatı
CIMR-TC4A0002BMA	Inverter T1000A, 400 V, ND: 2,1 A / 0,75 kW, HD: 1,8 A / 0,4 kW, IP20	770 EUR
CIMR-TC4A0004BMA	Inverter T1000A, 400 V, ND: 4,1 A / 1,5 kW, HD: 3,4 A / 0,75 kW, IP20	795 EUR
CIMR-TC4A0005BMA	Inverter T1000A, 400 V, ND: 5,4 A / 2,2 kW, HD: 4,8 A / 1,5 kW, IP20	847 EUR
CIMR-TC4A0007BMA	Inverter T1000A, 400 V, ND: 6,9 A / 3 kW, HD: 5,5 A / 2,2 kW, IP20	1.152 EUR
CIMR-TC4A0009BMA	Inverter T1000A, 400 V, ND: 8,8 A / 3,7 kW, HD: 7,2 A / 3 kW, IP20	1.250 EUR
CIMR-TC4A0011BMA	Inverter T1000A, 400 V, ND: 11,1 A / 5,5 kW, HD: 9,2 A / 4 kW, IP20	1.262 EUR
CIMR-TC4A0018BMA	Inverter T1000A, 400 V, ND: 17,5 A / 7,5 kW, HD: 14,8 A / 5,5 kW, IP20	1.286 EUR
CIMR-TC4A0023BMA	Inverter T1000A, 400 V, ND: 23 A / 11 kW, HD: 18 A / 7,5 kW, IP20	1.356 EUR
CIMR-TC4A0031BMA	Inverter T1000A, 400 V, ND: 31 A / 15 kW, HD: 24 A / 11 kW, IP20	1.966 EUR
CIMR-TC4A0038BMA	Inverter T1000A, 400 V, ND: 38 A / 18,5 kW, HD: 31 A / 15 kW, IP20	2.119 EUR
CIMR-TC4A0044BMA	Inverter T1000A, 400 V, ND: 44 A / 22 kW, HD: 39 A / 18,5 kW, IP20	2.633 EUR
CIMR-TC4A0058BMA	Inverter T1000A, 400 V, ND: 58 A / 30 kW, HD: 45 A / 22 kW, IP20	3.154 EUR
CIMR-TC4A0072BMA	Inverter T1000A, 400 V, ND: 72 A / 37 kW, HD: 60 A / 30 kW, IP20	3.602 EUR
CIMR-TC4A0088BMA	Inverter T1000A, 400 V, ND: 88 A / 45 kW, HD: 75 A / 37 kW, IP20	4.350 EUR
CIMR-TC4A0103BMA	Inverter T1000A, 400 V, ND: 103 A / 55 kW, HD: 91 A / 45 kW, IP20	4.940 EUR
CIMR-TC4A0139CMA	Inverter T1000A, 400 V, ND: 139 A / 75 kW, HD: 112 A / 55 kW, IP20	5.922 EUR
CIMR-TC4A0165CMA	Inverter T1000A, 400 V, ND: 165 A / 90 kW, HD: 150 A / 75 kW, IP20	7.336 EUR
CIMR-TC4A0208CMA	Inverter T1000A, 400 V, ND: 208 A / 110 kW, HD: 180 A / 90 kW, IP20	8.991 EUR
CIMR-TC4A0250CMA	Inverter T1000A, 400 V, ND: 250 A / 132 kW, HD: 216 A / 110 kW, IP20	9.777 EUR
CIMR-TC4A0296CMA	Inverter T1000A, 400 V, ND: 296 A / 160 kW, HD: 260 A / 132 kW, IP20	12.731 EUR
CIMR-TC4A0362CMA	Inverter T1000A, 400 V, ND: 362 A / 185 kW, HD: 304 A / 160 kW, IP20	15.106 EUR

### Inverter T1000A 400 VAC Three Phase - Cold Plate / Finless / Fanless

Ürün Kodu	Açıklama	Liste Fiyatı
CIMR-TC4A0058JMA	Inverter T1000A, 400 V, ND: 58 A / 30 kW, HD: 45 A / 22 kW, Cold Plate	3.154 EUR
CIMR-TC4A0072JMA	Inverter T1000A, 400 V, ND: 72 A / 37 kW, HD: 60 A / 30 kW, Cold Plate	3.442 EUR
CIMR-TC4A0088JMA	Inverter T1000A, 400 V, ND: 88 A / 45 kW, HD: 75 A / 37 kW, Cold Plate	3.774 EUR
CIMR-TC4A0103JMA	Inverter T1000A, 400 V, ND: 103 A / 55 kW, HD: 91 A / 45 kW, Cold Plate	4.503 EUR
CIMR-TC4A0139JMA	Inverter T1000A, 400 V, ND: 139 A / 75 kW, HD: 112 A / 55 kW, Cold Plate	6.173 EUR
CIMR-TC4A0165JMA	Inverter T1000A, 400 V, ND: 165 A / 90 kW, HD: 150 A / 75 kW, Cold Plate	6.868 EUR

### EMC Line-Filters for T1000A 400VAC (UL on request)

Ürün Kodu	Açıklama	Liste Fiyatı
FB-40008A	EMC Line-Filter for CIMR-TC4A0002 - 0007. EN61800-3 Class C1 (25m) C2 (50m), 8 Amp.	105 EUR
FB-40014A	EMC Line-Filter for CIMR-TC4A0009, 0011. EN61800-3 Class C1 (25m) C2 (50m), 14 Amp.	120 EUR
FB-40025A	EMC Line-Filter for CIMR-TC4A0018, 0023. EN61800-3 Class C1 (25m) C2 (50m), 25 Amp.	149 EUR
FB-40044A	EMC Line-Filter for CIMR-TC4A0031, 0038. EN61800-3 Class C1 (25m) C2 (50m), 44 Amp.	200 EUR
FB-40060A	EMC Line-Filter for CIMR-TC4A0044, 0058. EN61800-3 Class C1 (25m) C2 (50m), 60 Amp.	251 EUR
FB-40072A	EMC Line-Filter for CIMR-TC4A0072. EN61800-3 Class C2 (50m), 72 Amp.	340 EUR
FB-40105A	EMC Line-Filter for CIMR-TC4A0088, 0103. EN61800-3 Class C2 (50m), 105 Amp.	455 EUR
FB-40170A	EMC Line-Filter for CIMR-TC4A0139, 0165. EN61800-3 Class C2 (50m), 170 Amp.	696 EUR
FB-40250A	EMC Line-Filter for CIMR-TC4A0208, 0250. EN61800-3 Class C2 (50m), 250 Amp.	800 EUR
FB-40414A	EMC Line-Filter for CIMR-TC4A0296, 0362. EN61800-3 Class C2 (50m), 414 Amp.	1.107 EUR

All filters below incl. FB-40044A are footmount.

## Options for T1000A Series

Ürün Kodu	Açıklama	Liste Fiyatı
EZZ021136A	NEMA1 Kit for Inverter A1000, T1000A 200V 110A	281 EUR
EZZ021136B	NEMA1 Kit for Inverter A1000, T1000A 200V 138A	310 EUR
EZZ021136C	NEMA1 Kit for Inverter A1000, T1000A 200V 169A, 211A - 400V 139A, 165A	327 EUR
EZZ021136D	NEMA1 Kit for Inverter A1000, T1000A 200V 250A, 312A - 400V 208A	523 EUR
EZZ021136E	NEMA1 Kit for Inverter A1000, T1000A 200V 360A - 400V 250A, 296A, 362A	640 EUR
EZZ021136F	NEMA1 Kit for Inverter A1000, T1000A 400V 58A	560 EUR
EZZ021136G	NEMA1 Kit for Inverter A1000, T1000A 400V 72A	270 EUR
EZZ021136H	NEMA1 Kit for Inverter A1000, T1000A 400V 88A, 103A	270 EUR
AI-A3	Analog Input card (3 inputs)	179 EUR
AO-A3	2 additional Analog Output	133 EUR
CDBR-2022D	200V Braking Transistor Unit 22kW	561 EUR
CDBR-2037D	200V Braking Transistor Unit 37kW	843 EUR
CDBR-2055D	200V Braking Transistor Unit 45kW	1.715 EUR
CDBR-2110D	200V Braking Transistor Unit 110kW	1.968 EUR
CDBR-4045D	400V Braking Transistor Unit 45kW	575 EUR
CDBR-4090D	400V Braking Transistor Unit 90kW	1.803 EUR
CDBR-4220D	400V Braking Transistor Unit 220kW	2.302 EUR
DI-A3	Digital Input (BCD Code)	109 EUR
DO-A3	Digital Output (6 open collector 2 relais)	109 EUR
EUOP-V11001	IP54/65 Operator Frame	25 EUR
EZZ020642A	Operator Attachment IP 20 with screws	24 EUR
EZZ020642B	Operator Attachment IP 20 with nuts	18 EUR
EZZ020800A	Heatsink external Attachment T1000A 200V 4A, 6A,8A, 10A, 12A - 400V 2A, 4A, 5A	70 EUR
EZZ020800B	Heatsink external Attachment T1000A 200V 18A, 21A, 30A, 40A - 400V 7A, 9A,11A, 18A, 23A	70 EUR
EZZ020800C	Heatsink external Attachment T1000A 200V 56A - 400V 31A, 38A	77 EUR
EZZ020800D	Heatsink external Attachment T1000A 200V 69A, 81A - 400V 44A	83 EUR
EZZ021710A	Retrofit Attachment for CDBR-2022D, 2037D, 4030D, 4045D	36 EUR
EZZ021711A	External Heatsink Attachment for CDBR-2037D, 4045D, 5037D	45 EUR
JVOP-180	LCD Operator 1000 Series (standard in T1000A included)	133 EUR
JVOP-181	Copy unit w/USB converter	232 EUR
JVOP-182	LED Operator 1000 Series	63 EUR
MANUAL	Technical Manual - Printed Version - for T1000A Series	64 EUR
PG-B3	Open Collector PG-Interface 50kHz	104 EUR
PG-X3	Line Driver PG-Interface 300kHz	104 EUR
PS-A10HB	Power Supply Unit 24VDC (400V)	187 EUR
PS-A10LB	Power Supply Unit 24VDC (200V)	187 EUR
SI-C3	Comm. Interface T1000A CCLink	259 EUR
SI-EL3	Comm. Interface T1000A Powerlink	558 EUR
SI-EN3	Comm.Interface T1000A EtherNet IP	333 EUR
SI-EM3	Comm.Interface T1000A Modbus TCP	356 EUR
SI-EM3D	Comm.Interface T1000A Dual Port Modbus TCP	534 EUR
SI-EP3	Comm.Interface T1000A ProfiNet	498 EUR
EUOP-SI-ES3	Comm. Interface T1000A EtherCAT	351 EUR
SI-ES3	Comm. Interface A1000 EtherCAT *1	357 EUR
SI-N3	Comm. Interface T1000A DeviceNET	169 EUR
SI-P3	Comm. Interface T1000A ProfibusDP	361 EUR
SI-S3	Comm. Interface T1000A CANopen	187 EUR
SI-T3	Comm. Interface T1000A Mechatrolink II	242 EUR
WV001-YEG	1m extension cable for remote Digital Operator	51 EUR
WV003-YEG	3m extension cable for remote Digital Operator	60 EUR

\*1: Note: The SI-ES option card will replace the EUOP-SI-ES3 card. Both cards will be available in parallel for a certain period of time. On the SI-ES3 card a few functions work in a different way than on the EUOP-SI-ES3 card. Therefore we recommend:

- not to mix SI-ES3 and EUOP-SI-ES3 cards in one project.
- use the SI-ES3, NOT EUOP-SI-ES3 for new projects.

Information on compatibility can be obtained from our technical support.



## L1000A Inverter

- @ 4 - 75kW (200VAC -45 kW)
- @ 200VAC & 400VAC
- @ 8 dig. Input / 2 Analogue Inputs / 2 Safety Inputs
- @ 1 Pulse Output / 2 Analog Output / 3 Relay Output / 1 Fault Relay / Safety Monitor
- @ V/f / Open Loop Vector / Closed Loop Vector for IM & PM
- @ Integrated EN81-A3 compliant brake monitoring function
- @ DCP3-Interface for easy serial connection with lift control
- @ DCP4-Interface and CANLift is in preparation
- @ Supports most common encoder protocols: HTL, TTL, Resolver, EnDat, Hiperface
- @ Safety Standard: STO (Safe Torque Off) according to EN ISO 13849-1, Cat. 3, PL e; IEC EN 61508 SIL3

### Inverter L1000A 400 VAC Three Phase - IP20, with SiL3 STO

Ürün Kodu	Açıklama	Liste Fiyatı
CIMR-LC4F0005BAC	Inverter L1000A, 400 V, HD: 4,4 A / 1,5 kW, IP20, with SiL3 STO	1.799 EUR
CIMR-LC4F0006BAC	Inverter L1000A, 400 V, HD: 6,0 A / 2,2 kW, IP20, with SiL3 STO	1.978 EUR
CIMR-LC4F0009BAC	Inverter L1000A, 400 V, HD: 9,2 A / 4 kW, IP20, with SiL3 STO	1.654 EUR
CIMR-LC4F0015BAC	Inverter L1000A, 400 V, HD: 14,8 A / 5,5 kW, IP20, with SiL3 STO	1.799 EUR
CIMR-LC4F0018BAC	Inverter L1000A, 400 V, HD: 18 A / 7,5 kW, IP20, with SiL3 STO	1.861 EUR
CIMR-LC4F0024BAC	Inverter L1000A, 400 V, HD: 24 A / 11 kW, IP20, with SiL3 STO	2.457 EUR
CIMR-LC4F0031BAC	Inverter L1000A, 400 V, HD: 31 A / 15 kW, IP20, with SiL3 STO	3.159 EUR
CIMR-LC4F0039BAC	Inverter L1000A, 400 V, HD: 39 A / 18 kW, IP20, with SiL3 STO	3.745 EUR
CIMR-LC4F0045BAC	Inverter L1000A, 400 V, HD: 45 A / 22 kW, IP20, with SiL3 STO	4.316 EUR
CIMR-LC4F0060BAC	Inverter L1000A, 400 V, HD: 60 A / 30 kW, IP20, with SiL3 STO	6.084 EUR
CIMR-LC4F0075BAC	Inverter L1000A, 400 V, HD: 75 A / 37 kW, IP20, with SiL3 STO	7.557 EUR
CIMR-LC4F0091BAC	Inverter L1000A, 400 V, HD: 91 A / 45 kW, IP20, with SiL3 STO	7.945 EUR
CIMR-LC4F0112CAC	Inverter L1000A, 400 V, HD: 112 A / 55 kW, IP20, with SiL3 STO	8.450 EUR
CIMR-LC4F0150CAC	Inverter L1000A, 400 V, HD: 150 A / 75 kW, IP20, with SiL3 STO	10.261 EUR
CIMR-LC4F0180CAC	Inverter L1000A, 400 V, HD: 180 A / 90 kW, IP20, with SiL3 STO	16.101 EUR
CIMR-LC4F0216CAC	Inverter L1000A, 400 V, HD: 216 A / 110 kW, IP20, with SiL3 STO	18.672 EUR

### Inverter L1000A 400 VAC Three Phase - IP20, with SiL3 STO and A3/DCP3

Ürün Kodu	Açıklama	Liste Fiyatı
CIMR-LC4F0005BAC-9130	Inverter L1000A, 400 V, HD: 4,4 A / 1,5 kW, IP20, with SiL3 STO and A3/DCP3	1.889 EUR
CIMR-LC4F0006BAC-9130	Inverter L1000A, 400 V, HD: 6,0 A / 2,2 kW, IP20, with SiL3 STO and A3/DCP3	2.077 EUR
CIMR-LC4F0009BAC-9130	Inverter L1000A, 400 V, HD: 9,2 A / 4 kW, IP20, with SiL3 STO and A3/DCP3	1.849 EUR
CIMR-LC4F0015BAC-9130	Inverter L1000A, 400 V, HD: 14,8 A / 5,5 kW, IP20, with SiL3 STO and A3/DCP3	2.052 EUR
CIMR-LC4F0018BAC-9130	Inverter L1000A, 400 V, HD: 18 A / 7,5 kW, IP20, with SiL3 STO and A3/DCP3	2.121 EUR
CIMR-LC4F0024BAC-9130	Inverter L1000A, 400 V, HD: 24 A / 11 kW, IP20, with SiL3 STO and A3/DCP3	2.726 EUR
CIMR-LC4F0031BAC-9130	Inverter L1000A, 400 V, HD: 31 A / 15 kW, IP20, with SiL3 STO and A3/DCP3	3.433 EUR
CIMR-LC4F0039BAC-9130	Inverter L1000A, 400 V, HD: 39 A / 18 kW, IP20, with SiL3 STO and A3/DCP3	4.059 EUR
CIMR-LC4F0045BAC-9130	Inverter L1000A, 400 V, HD: 45 A / 22 kW, IP20, with SiL3 STO and A3/DCP3	4.650 EUR
CIMR-LC4F0060BAC-9130	Inverter L1000A, 400 V, HD: 60 A / 30 kW, IP20, with SiL3 STO and A3/DCP3	6.429 EUR
CIMR-LC4F0075BAC-9130	Inverter L1000A, 400 V, HD: 75 A / 37 kW, IP20, with SiL3 STO and A3/DCP3	7.935 EUR
CIMR-LC4F0091BAC-9130	Inverter L1000A, 400 V, HD: 91 A / 45 kW, IP20, with SiL3 STO and A3/DCP3	8.342 EUR
CIMR-LC4F0112CAC-9130	Inverter L1000A, 400 V, HD: 112 A / 55 kW, IP20, with SiL3 STO and A3/DCP3	8.872 EUR
CIMR-LC4F0150CAC-9130	Inverter L1000A, 400 V, HD: 150 A / 75 kW, IP20, with SiL3 STO and A3/DCP3	10.774 EUR
CIMR-LC4F0180CAC-9130	Inverter L1000A, 400 V, HD: 180 A / 90 kW, IP20, with SiL3 STO and A3/DCP3	16.745 EUR
CIMR-LC4F0216CAC-9130	Inverter L1000A, 400 V, HD: 216 A / 110 kW, IP20, with SiL3 STO and A3/DCP3	19.419 EUR

### EMC Line-Filters for L1000A 400VAC (UL on request)

Ürün Kodu	Açıklama	Liste Fiyatı
FB-40008A	EMC Line-Filter for CIMR-LC4F0005. EN61800-3 Class C1, 8 Amp.	105 EUR
FB-40014A	EMC Line-Filter for CIMR-LC4F0006, 0009. EN61800-3 Class C1, 14 Amp.	120 EUR
FB-40025A	EMC Line-Filter for CIMR-LC4F0015, 0018. EN61800-3 Class C1, 25 Amp.	149 EUR
FB-40044A	EMC Line-Filter for CIMR-LC4F0024, 0031. EN61800-3 Class C1, 44 Amp.	200 EUR
FB-40060A	EMC Line-Filter for CIMR-LC4F0039, 0045. EN61800-3 Class C1, 60 Amp.	251 EUR
FB-40072A	EMC Line-Filter for CIMR-LC4F0060. EN61800-3 Class C1, 72 Amp.	340 EUR
FB-40105A	EMC Line-Filter for CIMR-LC4F0075, 0091. EN61800-3 Class C1, 105 Amp.	455 EUR
FB-40170A	EMC Line-Filter for CIMR-LC4F0112, 0150. EN61800-3 Class C1, 170 Amp.	696 EUR

## Line Reactors IP00 for L1000A 400 VAC

Ürün Kodu	Açıklama	Liste Fiyatı
B 1103136	Line Reactor IP00 for CIMR-LC4F0005, 0006, 0009. 8 Amp., 1,4 kg copper	129 EUR
B 1103138	Line Reactor IP00 for CIMR-LC4F0015, 0018. 16 Amp., 2,1 kg copper	170 EUR
B 1103139	Line Reactor IP00 for CIMR-LC4F0024. 21 Amp., 3,0 kg copper	243 EUR
B 1103140	Line Reactor IP00 for CIMR-LC4F0031. 27 Amp., 4,2 kg copper	284 EUR
B 1103141	Line Reactor IP00 for CIMR-LC4F0039, 0045. 38 Amp., 6,0 kg copper	513 EUR
B 1103142	Line Reactor IP00 for CIMR-LC4F0060, 0075. 65 Amp., 9,9 kg copper	671 EUR
B 0910013	Line Reactor IP00 for CIMR-LC4F0091, 0112. 96 Amp., 15,3 kg copper	931 EUR
B 1411053	Line Reactor IP00 for CIMR-LC4F0150, 0180. 155 Amp., 20,0 kg copper	2.449 EUR
B 0910013	Line Reactor IP00 for CIMR-LC4F0216. 96 Amp., 15,3 kg copper It is mandatory to use 2 pcs of the mentioned filter and switch them parallel.	931 EUR

Please note that we will add a copper fee to the above mentioned products on our order confirmation. The basis for the copper price which we will invoice is available on: <http://www.lme.com/copper.asp>. We use the following formula for the copper surcharge: ((3-month buyer\*exchange rate USD vs. EURO)/1000\*copper weight)

## IP20 Box for Line Reactors

Ürün Kodu	Açıklama	Liste Fiyatı
IP20-Box32	IP20 Box for Line Reactor type B 1103136	60 EUR
IP20-Box35	IP20 Box for Line Reactor type B 1103138	70 EUR
IP20-Box36	IP20 Box for Line Reactor type B 1103139	74 EUR
IP20-Box37	IP20 Box for Line Reactor type B 1103140	81 EUR
IP20-Box39	IP20 Box for Line Reactor type B 1103141, B 1103142	137 EUR
IP20-Box42	IP20 Box for Line Reactor type B 0910013	179 EUR
IP20-Box44	IP20 Box for Line Reactor type B 1411053	222 EUR

## Braking Resistor 50% ED

Ürün Kodu	Açıklama	Liste Fiyatı
RH-1000W120	Braking Resistor 50% ED for CIMR-LC4F0005, 0006, 0009, 0015. 1000W, 120Ohm	149 EUR
RH-1560W040	Braking Resistor 50% ED for CIMR-LC4F0018. 1560W, 40Ohm	187 EUR
RH-2700W025	Braking Resistor 50% ED for CIMR-LC4F0024. 2700W, 25Ohm	268 EUR
RH-3700W025	Braking Resistor 50% ED for CIMR-LC4F0031. 3700W, 25Ohm	324 EUR
RH-4800W022	Braking Resistor 50% ED for CIMR-LC4F0039. 4800W, 22Ohm	414 EUR
RH-6000W022	Braking Resistor 50% ED for CIMR-LC4F0045. 6000W, 22Ohm	494 EUR
RH-7500W023	Braking Resistor 50% ED for CIMR-LC4F0060. 7500W, 23Ohm	557 EUR

## Inverter L1000A 200 VAC Three Phase - IP20

Ürün Kodu	Açıklama	Liste Fiyatı
CIMR-LC2A0008BAC	Inverter L1000A, 200 V, HD: 7.5 A / 1.5 kW, IP20	1.647 EUR
CIMR-LC2A0011BAC	Inverter L1000A, 200 V, HD: 11 A / 2,2 kW, IP20	1.727 EUR
CIMR-LC2A0018BAC	Inverter L1000A, 200 V, HD: 17,5 A / 4 kW, IP20	1.913 EUR
CIMR-LC2A0025BAC	Inverter L1000A, 200 V, HD: 25 A / 5,5 kW, IP20	2.264 EUR
CIMR-LC2A0033BAC	Inverter L1000A, 200 V, HD: 33 A / 7,5 kW, IP20	2.547 EUR
CIMR-LC2A0047BAC	Inverter L1000A, 200 V, HD: 47 A / 11 kW, IP20	3.198 EUR
CIMR-LC2A0060BAC	Inverter L1000A, 200 V, HD: 60 A / 15 kW, IP20	4.488 EUR
CIMR-LC2A0075BAC	Inverter L1000A, 200 V, HD: 75 A / 18 kW, IP20	6.437 EUR
CIMR-LC2A0085BAC	Inverter L1000A, 200 V, HD: 85 A / 22 kW, IP20	7.877 EUR
CIMR-LC2A0115BAC	Inverter L1000A, 200 V, HD: 115 A / 30 kW, IP20	8.579 EUR
CIMR-LC2A0145CAC	Inverter L1000A, 200 V, HD: 145 A / 37 kW, IP20	10.391 EUR
CIMR-LC2A0180CAC	Inverter L1000A, 200 V, HD: 180 A / 45 kW, IP20	11.474 EUR
CIMR-LC2A0215CAC	Inverter L1000A, 200 V, HD: 215 A / 55 kW, IP20	20.110 EUR
CIMR-LC2A0283CAC	Inverter L1000A, 200 V, HD: 283 A / 75 kW, IP20	Sorunuz
CIMR-LC2A0346CAC	Inverter L1000A, 200 V, HD: 346 A / 90 kW, IP20	28.140 EUR
CIMR-LC2A0415CAC	Inverter L1000A, 200 V, HD: 415 A / 110 kW, IP20	31.432 EUR

## Options for L1000A Series

Ürün Kodu	Açıklama	Liste Fiyatı
AO-A3	2 additional Analog Output	133 EUR
CDBR-2022D	200V Braking Transistor Unit 22kW	561 EUR
CDBR-2037D	200V Braking Transistor Unit 37kW	843 EUR
CDBR-2055D	200V Braking Transistor Unit 45kW	1.715 EUR
CDBR-2110D	200V Braking Transistor Unit 110kW	1.968 EUR
CDBR-4045D	400V Braking Transistor Unit 45kW	575 EUR
CDBR-4090D	400V Braking Transistor Unit 90kW	1.803 EUR
CDBR-4220D	400V Braking Transistor Unit 220kW	2.302 EUR
DI-A3	Digital Input (BCD Code)	109 EUR
DO-A3	Digital Output (6 open collector 2 relays)	109 EUR
EZZ020642A	Operator Attachment IP 20 with screws	24 EUR
EZZ020642B	Operator Attachment IP 20 with nuts	18 EUR
EZZ021710A	Retrofit Attachment for CDBR-2022D, 2037D, 4030D, 4045D	36 EUR
EZZ021711A	External Heatsink Attachment for CDBR-2037D, 4045D, 5037D	45 EUR
EUOP-V11001	IP54/65 Operator Frame	25 EUR
JVOP-180	LCD Operator 1000 Series (is as standard in L1000 included)	133 EUR
JVOP-181	Copy unit wUSB converter	232 EUR
JVOP-182	LED Operator 1000 Series	63 EUR
MANUAL	Technical Manual - Printed Version - for L1000A Series	64 EUR
PG-B3	Open Collector PG-Interface Card 50kHz	104 EUR
PG-X3	Line Driver PG-Interface Card 300kHz	104 EUR
PG-E3	ERN1387 PG-Interface Card	207 EUR
PG-F3	EnDat Encoder PG-Interface Card	207 EUR
PG-RT3	TS2640N321E64 PG-Interface Card	355 EUR
PS-A10HB	Power Supply Unit 24VDC (400V)	187 EUR
PS-A10LB	Power Supply Unit 24VDC (200V)	187 EUR
SI-S3	Comm. Interface CANopen	187 EUR
WV001-YEG	1m extension cable for remote Digital Operator	51 EUR
WV003-YEG	3m extension cable for remote Digital Operator	60 EUR





## Liftmotor MSYP-Series

- @ 240 kg to 2.500 kg
- @ Gearless synchronmotor
- @ Speed: up to 2,5 m/s
- @ Combination with Yaskawa Lift Inverter L1000A recommended
- @ Packaging: carton on euro palette, dimension: 800 x 600 x 550mm, Packaging weight: appr. 15 kgs
- @ Variations on rated speed, applied load or roping possible - upon request

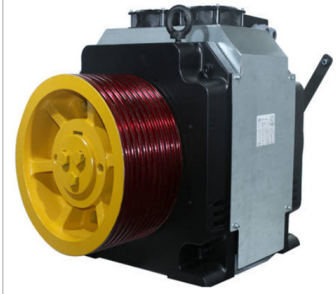

### MSYP-160 Roping = 1:1, Speed = 1m/s

Ürün Kodu	Açıklama	Liste Fiyatı
MSYP160.25-20240080	Lift Motor Q=240kg@80 (1m/s) 1:1; traction sheave Dia 240 mm; 5 grooves for rope dia 6,5mm, rated power 1,5 kW 5,2A@eta shaft 80%	7.241 EUR
MSYP160.30-20320080	Lift Motor Q=320kg@80 (1m/s) 1:1; traction sheave Dia 240 mm; 7 grooves for rope dia 6,5mm, rated power 2 kW 7,1A@eta shaft 80%	7.607 EUR
MSYP160.40-20400080	Lift Motor Q=400kg@80 (1m/s) 1:1; traction sheave Dia 240 mm; 7 grooves for rope dia 6,5mm, rated power 2,5 kW 8,1A@eta shaft 80%	8.260 EUR
MSYP160.50-20480080	Lift Motor Q=480kg@80 (1m/s) 1:1; traction sheave Dia 240 mm; 10 grooves for rope dia 6,5mm, rated power 3 kW 8,9A@eta shaft 80%	9.281 EUR
MSYP160.60-20630080	Lift Motor Q=630kg@80 (1m/s) 1:1; traction sheave Dia 240 mm; 10 grooves for rope dia 6,5mm, rated power 3,9 kW 12,1A@eta shaft 80%	9.972 EUR
MSYP160.40-20320060	Lift Motor Q=320kg@60 (1m/s) 1:1; traction sheave Dia 320 mm; 6 grooves for rope dia 8mm, rated power 2 kW 6,7A@eta shaft 80%	8.381 EUR
MSYP160.60-20480060	Lift Motor Q=480kg@60 (1m/s) 1:1; traction sheave Dia 320 mm; 6 grooves for rope dia 8mm, rated power 3 kW 10,6A@eta shaft 80%	9.982 EUR

### MSYP-160 Roping = 2:1, Speed = 1m/s

Ürün Kodu	Açıklama	Liste Fiyatı
MSYP160.20-20320160	Lift Motor Q=320kg@160 (1m/s) 2:1; traction sheave Dia 240 mm; 5 grooves for rope dia 6,5mm, rated power 2 kW 5,6A@eta shaft 80%	6.756 EUR
MSYP160.20-20400160	Lift Motor Q=400kg@160 (1m/s) 2:1; traction sheave Dia 240 mm; 5 grooves for rope dia 6,5mm, rated power 2,5 kW 7,9A@eta shaft 80%	6.756 EUR
MSYP160.25-20480160	Lift Motor Q=480kg@160 (1m/s) 2:1; traction sheave Dia 240 mm; 5 grooves for rope dia 6,5mm, rated power 3 kW 8,8A@eta shaft 80%	7.241 EUR
MSYP160.30-20630160	Lift Motor Q=630kg@160 (1m/s) 2:1; traction sheave Dia 240 mm; 7 grooves for rope dia 6,5mm, rated power 3,9 kW 11,9A@eta shaft 80%	7.607 EUR
MSYP160.50-20100160	Lift Motor Q=1000kg@160 (1m/s) 2:1; traction sheave Dia 240 mm; 10 grooves for rope dia 6,5mm, rated power 6,1 kW 16,8A@eta shaft 80%	9.281 EUR
MSYP160.60-20125160	Lift Motor Q=1250kg@160 (1m/s) 2:1; traction sheave Dia 240 mm; 10 grooves for rope dia 6,5mm, rated power 7,7 kW 21A@eta shaft 80%	9.972 EUR
MSYP160.30-20480120	Lift Motor Q=480kg@120 (1m/s) 2:1; traction sheave Dia 320 mm; 6 grooves for rope dia 8mm, rated power 3 kW 9,2A@eta shaft 80%	7.728 EUR
MSYP160.40-20630120	Lift Motor Q=630kg@120 (1m/s) 2:1; traction sheave Dia 320 mm; 6 grooves for rope dia 8mm, rated power 3,9 kW 10,9A@eta shaft 80%	8.381 EUR
MSYP160.50-20800120	Lift Motor Q=800kg@120 (1m/s)2:1; traction sheave Dia 320 mm; 6 grooves for rope dia 8mm, rated power 4,9 kW A@eta shaft 80%	9.177 EUR
MSYP160.60-20100120	Lift Motor Q=1000kg@120 (1m/s) 2:1; traction sheave Dia 320 mm; 6 grooves for rope dia 8mm, rated power 6,1 kW 18,4A@eta shaft 80%	9.982 EUR

## MSYP-160 Roping = 1:1, Speed = 1,6m/s

Ürün Kodu	Açıklama	Liste Fiyatı
MSYP160.25-20240128	Lift Motor Q=240kg@128 (1,6m/s)1:1; traction sheave Dia 240 mm; 5 grooves for rope dia 6,5mm, rated power 2,4 kW A@eta shaft 80%	7.241 EUR
MSYP160.30-20320128	Lift Motor Q=320kg@128 (1,6m/s)1:1; traction sheave Dia 240 mm; 7 grooves for rope dia 6,5mm, rated power 3,1 kW A@eta shaft 80%	7.607 EUR
MSYP160.40-20400128	Lift Motor Q=400kg@128 (1,6m/s)1:1; traction sheave Dia 240 mm; 7 grooves for rope dia 6,5mm, rated power 3,9 kW A@eta shaft 80%	8.260 EUR
MSYP160.50-20480128	Lift Motor Q=480kg@128 (1,6m/s)1:1; traction sheave Dia 240 mm; 10 grooves for rope dia 6,5mm, rated power 4,7 kW A@eta shaft 80%	9.281 EUR
MSYP160.60-20630128	Lift Motor Q=630kg@128 (1,6m/s)1:1; traction sheave Dia 240 mm; 10 grooves for rope dia 6,5mm, rated power 6,2 kW A@eta shaft 80%	9.972 EUR
MSYP160.40-20320096	Lift Motor Q=320kg@96 (1,6m/s) 1:1; traction sheave Dia 320 mm; 6 grooves for rope dia 8mm, rated power 3,1 kW A@eta shaft 80%	8.381 EUR
MSYP160.60-20480096	Lift Motor Q=480kg@96 (1,6m/s) 1:1; traction sheave Dia 320 mm; 6 grooves for rope dia 8mm, rated power 4,7 kW A@eta shaft 80%	9.982 EUR

## MSYP-160 Roping = 2:1, Speed = 1,6m/s

Ürün Kodu	Açıklama	Liste Fiyatı
MSYP160.20-20320255	Lift Motor Q=320kg@255 (1,6m/s)2:1; traction sheave Dia 240 mm; 5 grooves for rope dia 6,5mm, rated power 3,1 kW A@eta shaft 80%	6.756 EUR
MSYP160.20-20400255	Lift Motor Q=400kg@255 (1,6m/s)2:1; traction sheave Dia 240 mm; 5 grooves for rope dia 6,5mm, rated power 3,9 kW A@eta shaft 80%	6.756 EUR
MSYP160.25-20480255	Lift Motor Q=480kg@255 (1,6m/s)2:1; traction sheave Dia 240 mm; 5 grooves for rope dia 6,5mm, rated power 4,7 kW A@eta shaft 80%	7.241 EUR
MSYP160.30-20630255	Lift Motor Q=630kg@255 (1,6m/s)2:1; traction sheave Dia 240 mm; 7 grooves for rope dia 6,5mm, rated power 6,2 kW A@eta shaft 80%	7.607 EUR
MSYP160.50-20100255	Lift Motor Q=1000kg@255 (1,6m/s)2:1; traction sheave Dia 240 mm; 10 grooves for rope dia 6,5mm, rated power 9,8 kW A@eta shaft 80%	9.281 EUR
MSYP160.60-20125255	Lift Motor Q=1250kg@255 (1,6m/s)2:1; traction sheave Dia 240 mm; 10 grooves for rope dia 6,5mm, rated power 12,3 kW A@eta shaft 80%	9.972 EUR
MSYP160.30-20480191	Lift Motor Q=480kg@191 (1,6m/s) 2:1; traction sheave Dia 320 mm; 6 grooves for rope dia 8mm, rated power 4,7 kW 12,2A@eta shaft 80%	7.728 EUR
MSYP160.40-20630191	Lift Motor Q=630kg@191 (1,6m/s) 2:1; traction sheave Dia 320 mm; 6 grooves for rope dia 8mm, rated power 6,2 kW 14,6A@eta shaft 80%	8.381 EUR
MSYP160.50-20800191	Lift Motor Q=800kg@191 (1,6m/s) 2:1; traction sheave Dia 320 mm; 6 grooves for rope dia 8mm, rated power 7,8 kW A@eta shaft 80%	9.177 EUR
MSYP160.60-20100191	Lift Motor Q=1000kg@191 (1,6m/s) 2:1; traction sheave Dia 320 mm; 6 grooves for rope dia 8mm, rated power 9,8 kW 23,3A@eta shaft 80%	9.982 EUR

## MSYP-225 Roping = 1:1, Max Travel = 30m, Speed = 1m/s

Ürün Kodu	Açıklama	Liste Fiyatı
MSYP225.28-20630060	Lift Motor Q=630kg@60 1:1; traction sheave Dia 320 mm; 10 grooves for rope dia 8mm, rated power 4,4 kW 16A@eta shaft 70%, max travel 30m (1m/s, 40%ED, 180starts, 150%overload, 66% Equivalent constant torque)	20.149 EUR
MSYP225.44-20800060	Lift Motor Q=800kg@60 1:1; traction sheave Dia 320 mm; 10 grooves for rope dia 8mm, rated power 5,6 kW 15,75A@eta shaft 70%, max travel 30m (1m/s, 40%ED, 180starts, 150%overload, 66% Equivalent constant torque)	22.225 EUR
MSYP225.52-20100060	Lift Motor Q=1000kg@60 1:1; traction sheave Dia 320 mm; 10 grooves for rope dia 8mm, rated power 7 kW 21A@eta shaft 70%, max travel 30m (1m/s, 40%ED, 180starts, 150%overload, 66% Equivalent constant torque)	23.820 EUR
MSYP225.60-20125060	Lift Motor Q=1250kg@60 1:1; traction sheave Dia 320 mm; 10 grooves for rope dia 8mm, rated power 9 kW 26,5A@eta shaft 70%, max travel 30m (1m/s, 40%ED, 180starts, 150%overload, 66% Equivalent constant torque)	27.094 EUR
MSYP225.52-20800048	Lift Motor Q=800kg@48 1:1; traction sheave Dia 400 mm; 10 grooves for rope dia 10mm, rated power 5,6 kW 16,8A@eta shaft 70%, max travel 30m (1m/s, 40%ED, 180starts, 150%overload, 66% Equivalent constant torque)	25.006 EUR
MSYP225.60-20100048	Lift Motor Q=1000kg@48 1:1; traction sheave Dia 400 mm; 10 grooves for rope dia 10mm, rated power 7 kW 22A@eta shaft 70%, max travel 30m (1m/s, 40%ED, 180starts, 150%overload, 66% Equivalent constant torque)	27.358 EUR

## MSYP-225 Roping = 2:1, Max Travel = 30m, Speed = 1m/s

Ürün Kodu	Açıklama	Liste Fiyatı
MSYP225.44-20125120	Lift Motor Q=1250kg@120 2:1; traction sheave Dia 320 mm; 10 grooves for rope dia 8mm, rated power 8,8 kW 19A@eta shaft 70%, max travel 30m (1m/s, 40%ED, 180starts, 150%overload, 66% Equivalent constant torque)	22.225 EUR
MSYP225.44-20160120	Lift Motor Q=1600kg@120 2:1; traction sheave Dia 320 mm; 10 grooves for rope dia 8mm, rated power 11,2 kW 28A@eta shaft 70%, max travel 30m (1m/s, 40%ED, 180starts, 150%overload, 66% Equivalent constant torque)	22.225 EUR
MSYP225.52-20200120	Lift Motor Q=2000kg@120 2:1; traction sheave Dia 320 mm; 10 grooves for rope dia 8mm, rated power 14 kW 35A@eta shaft 70%, max travel 30m (1m/s, 40%ED, 180starts, 150%overload, 66% Equivalent constant torque)	23.820 EUR
MSYP225.64-20250120	Lift Motor Q=2500kg@120 2:1; traction sheave Dia 320 mm; 10 grooves for rope dia 8mm, rated power 17,5 kW 44A@eta shaft 70%, max travel 30m (1m/s, 40%ED, 180starts, 150%overload, 66% Equivalent constant torque)	29.339 EUR
MSYP225.52-20160096	Lift Motor Q=1600kg@96 2:1; traction sheave Dia 400 mm; 10 grooves for rope dia 10mm, rated power 11,2 kW 20,5A@eta shaft 70%, max travel 30m (1m/s, 40%ED, 180starts, 150%overload, 66% Equivalent constant torque)	25.006 EUR
MSYP225.64-20200096	Lift Motor Q=2000kg@96 2:1; traction sheave Dia 400 mm; 10 grooves for rope dia 10mm, rated power 14 kW 35,5A@eta shaft 70%, max travel 30m (1m/s, 40%ED, 180starts, 150%overload, 66% Equivalent constant torque)	29.542 EUR

## MSYP-225 Roping = 1:1, Max Travel = 75m, Speed = 1,6m/s

Ürün Kodu	Açıklama	Liste Fiyatı
MSYP225.44-20630095	Lift Motor Q=630kg@95,4 1:1; traction sheave Dia 320 mm; 10 grooves for rope dia 8mm, rated power 7,1 kW 16,5A@eta shaft 70%, travel height Max. 75m (1,6m/s, 50%ED, 240starts, 150%overload, 76% Equivalent constant torque)	22.225 EUR
MSYP225.44-20800095	Lift Motor Q=800kg@95,4 1:1; traction sheave Dia 320 mm; 10 grooves for rope dia 8mm, rated power 9 kW 23,5A@eta shaft 70%, travel height Max. 75m (1,6m/s, 50%ED, 240starts, 150%overload, 76% Equivalent constant torque)	22.225 EUR
MSYP225.60-20100095	Lift Motor Q=1000kg@95,4 1:1; traction sheave Dia 320 mm; 10 grooves for rope dia 8mm, rated power 11,3 kW 27A@eta shaft 70%, travel height Max. 75m (1,6m/s, 50%ED, 240starts, 150%overload, 76% Equivalent constant torque)	25.161 EUR
MSYP225.72-20125095	Lift Motor Q=1250kg@95,4 1:1; traction sheave Dia 320 mm; 10 grooves for rope dia 8mm, rated power 14,1 kW 34A@eta shaft 70%, travel height Max. 75m (1,6m/s, 50%ED, 240starts, 150%overload, 76% Equivalent constant torque)	31.104 EUR
MSYP225.60-20800076	Lift Motor Q=800kg@76,2 1:1; traction sheave Dia 400 mm; 10 grooves for rope dia 10mm, rated power 9 kW 22A@eta shaft 70%, travel height Max. 75m (1,6m/s, 50%ED, 240starts, 150%overload, 76% Equivalent constant torque)	25.424 EUR
MSYP225.68-20100076	Lift Motor Q=1000kg@76,2 1:1; traction sheave Dia 400 mm; 10 grooves for rope dia 10mm, rated power 11,3 kW 28A@eta shaft 70%, travel height Max. 75m (1,6m/s, 50%ED, 240starts, 150%overload, 76% Equivalent constant torque)	30.411 EUR

## MSYP-225 Roping = 2:1, Max Travel = 75m, Speed = 1,6m/s

Ürün Kodu	Açıklama	Liste Fiyatı
MSYP225.44-20125191	Lift Motor Q=1250kg@191 2:1; traction sheave Dia 320 mm; 10 grooves for rope dia 8mm, rated power 14 kW 30,5A@eta shaft 70%, travel height Max. 75m (1,6m/s, 50%ED, 240starts, 150%overload, 76% Equivalent constant torque)	22.225 EUR
MSYP225.52-20160191	Lift Motor Q=1600kg@191 2:1; traction sheave Dia 320 mm; 10 grooves for rope dia 8mm, rated power 18 kW 38A@eta shaft 70%, travel height Max. 75m (1,6m/s, 50%ED, 240starts, 150%overload, 76% Equivalent constant torque)	23.820 EUR
MSYP225.60-20200191	Lift Motor Q=2000kg@191 2:1; traction sheave Dia 320 mm; 10 grooves for rope dia 8mm, rated power 22,4 kW 49A@eta shaft 70%, travel height Max. 75m (1,6m/s, 50%ED, 240starts, 150%overload, 76% Equivalent constant torque)	25.161 EUR
MSYP225.72-20250191	Lift Motor Q=2500kg@191 2:1; traction sheave Dia 320 mm; 10 grooves for rope dia 8mm, rated power 28 kW 63A@eta shaft 70%, travel height Max. 75m (1,6m/s, 50%ED, 240starts, 150%overload, 76% Equivalent constant torque)	31.104 EUR
MSYP225.60-20160153	Lift Motor Q=1600kg@153 2:1; traction sheave Dia 400 mm; 10 grooves for rope dia 10mm, rated power 17,9 kW 41,5A@eta shaft 70%, travel height Max. 75m (1,6m/s, 50%ED, 240starts, 150%overload, 76% Equivalent constant torque)	25.424 EUR
MSYP225.72-20200153	Lift Motor Q=2000kg@153 2:1; traction sheave Dia 400 mm; 10 grooves for rope dia 10mm, rated power 22,4 kW 51A@eta shaft 70%, travel height Max. 75m (1,6m/s, 50%ED, 240starts, 150%overload, 76% Equivalent constant torque)	31.362 EUR

## MSYP-225 Roping = 1:1, Max Travel = 130m, Speed = 2m/s

Ürün Kodu	Açıklama	Liste Fiyatı
MSYP225.44-20630120	Lift Motor Q=630kg@120 1:1; traction sheave Dia 320 mm; 10 grooves for rope dia 8mm, rated power 9 kW 21A@eta shaft 70%, travel height Max. 130m (2m/s, 50%ED, 240starts, 180%overload, 80% Equivalent constant torque)	22.225 EUR
MSYP225.44-20800120	Lift Motor Q=800kg@120 1:1; traction sheave Dia 320 mm; 10 grooves for rope dia 8mm, rated power 11,3 kW 31A@eta shaft 70%, travel height Max. 130m (2m/s, 50%ED, 240starts, 180%overload, 80% Equivalent constant torque)	22.225 EUR
MSYP225.60-20100120	Lift Motor Q=1000kg@120 1:1; traction sheave Dia 320 mm; 10 grooves for rope dia 8mm, rated power 14 kW 35,5A@eta shaft 70%, travel height Max. 130m (2m/s, 50%ED, 240starts, 180%overload, 80% Equivalent constant torque)	25.161 EUR
MSYP225.60-20800095	Lift Motor Q=800kg@95,4 1:1; traction sheave Dia 400 mm; 10 grooves for rope dia 10mm, rated power 11,2 kW 29A@eta shaft 70%, travel height Max. 130m (2m/s, 50%ED, 240starts, 180%overload, 80% Equivalent constant torque)	25.424 EUR

## MSYP-225 Roping = 2:1, Max Travel = 130m, Speed = 2m/s

Ürün Kodu	Açıklama	Liste Fiyatı
MSYP225.52-20125239	Lift Motor Q=1250kg@239 2:1; traction sheave Dia 320 mm; 10 grooves for rope dia 8mm, rated power 17,5 kW 37,5A@eta shaft 70%, travel height Max. 130m (2m/s, 50%ED, 240starts, 180%overload, 80% Equivalent constant torque)	23.820 EUR
MSYP225.60-20160239	Lift Motor Q=1600kg@239 2:1; traction sheave Dia 320 mm; 10 grooves for rope dia 8mm, rated power 22,5 kW 48,1A@eta shaft 70%, travel height Max. 130m (2m/s, 50%ED, 240starts, 180%overload, 80% Equivalent constant torque)	25.161 EUR
MSYP225.64-20200239	Lift Motor Q=2000kg@239 2:1; traction sheave Dia 320 mm; 10 grooves for rope dia 8mm, rated power 28 kW 66,5A@eta shaft 70%, travel height Max. 130m (2m/s, 50%ED, 240starts, 180%overload, 80% Equivalent constant torque)	27.405 EUR
MSYP225.60-20125191	Lift Motor Q=1250kg@191 2:1; traction sheave Dia 400 mm; 10 grooves for rope dia 10mm, rated power 17,6 kW 38,5A@eta shaft 70%, travel height Max. 130m (2m/s, 50%ED, 240starts, 180%overload, 80% Equivalent constant torque)	25.424 EUR
MSYP225.68-20160191	Lift Motor Q=1600kg@191 2:1; traction sheave Dia 400 mm; 10 grooves for rope dia 10mm, rated power 22,4 kW 49,5A@eta shaft 70%, travel height Max. 130m (2m/s, 50%ED, 240starts, 180%overload, 80% Equivalent constant torque)	28.479 EUR

## MSYP-225 Roping = 1:1, Max Travel = 130m, Speed = 2,5m/s

Ürün Kodu	Açıklama	Liste Fiyatı
MSYP225.44-20630150	Lift Motor Q=630kg@150 1:1; traction sheave Dia 320 mm; 10 grooves for rope dia 8mm, rated power 11 kW 26A@eta shaft 70%, travel height Max. 130m (2,5m/s, 50%ED, 240starts, 180%overload, 85% Equivalent constant torque)	22.225 EUR
MSYP225.52-20800150	Lift Motor Q=800kg@150 1:1; traction sheave Dia 320 mm; 10 grooves for rope dia 8mm, rated power 14 kW 34,5A@eta shaft 70%, travel height Max. 130m (2,5m/s, 50%ED, 240starts, 180%overload, 85% Equivalent constant torque)	23.820 EUR
MSYP225.64-20100150	Lift Motor Q=1000kg@150 1:1; traction sheave Dia 320 mm; 10 grooves for rope dia 8mm, rated power 17,5 kW 40,6A@eta shaft 70%, travel height Max. 130m (2,5m/s, 50%ED, 240starts, 180%overload, 85% Equivalent constant torque)	27.405 EUR
MSYP225.64-20800120	Lift Motor Q=800kg@120 1:1; traction sheave Dia 400 mm; 10 grooves for rope dia 10mm, rated power 14 kW 35A@eta shaft 70%, travel height Max. 130m (2,5m/s, 50%ED, 240starts, 180%overload, 85% Equivalent constant torque)	27.670 EUR

## MSYP-225 Roping = 2:1, Max Travel = 130m, Speed = 2,5m/s

Ürün Kodu	Açıklama	Liste Fiyatı
MSYP225.52-20125299	Lift Motor Q=1250kg@299 2:1; traction sheave Dia 320 mm; 10 grooves for rope dia 8mm, rated power 22 kW 47A@eta shaft 70%, travel height Max. 130m (2,5m/s, 50%ED, 240starts, 180%overload, 85% Equivalent constant torque)	23.820 EUR
MSYP225.60-20160299	Lift Motor Q=1600kg@299 2:1; traction sheave Dia 320 mm; 10 grooves for rope dia 8mm, rated power 28 kW 62,5A@eta shaft 70%, travel height Max. 130m (2,5m/s, 50%ED, 240starts, 180%overload, 85% Equivalent constant torque)	25.161 EUR
MSYP225.72-20200299	Lift Motor Q=2000kg@299 2:1; traction sheave Dia 320 mm; 10 grooves for rope dia 8mm, rated power 35 kW A@eta shaft 70%, travel height Max. 130m (2,5m/s, 50%ED, 240starts, 180%overload, 85% Equivalent constant torque)	29.167 EUR
MSYP225.60-20125239	Lift Motor Q=1250kg@239 2:1; traction sheave Dia 400 mm; 10 grooves for rope dia 10mm, rated power 22 kW 47A@eta shaft 70%, travel height Max. 130m (2,5m/s, 50%ED, 240starts, 180%overload, 85% Equivalent constant torque)	25.424 EUR
MSYP225.72-20160239	Lift Motor Q=1600kg@239 2:1; traction sheave Dia 400 mm; 10 grooves for rope dia 10mm, rated power 28 kW 59A@eta shaft 70%, travel height Max. 130m (2,5m/s, 50%ED, 240starts, 180%overload, 85% Equivalent constant torque)	29.430 EUR

## Options for MSYP Lift Motors

Ürün Kodu	Açıklama	Liste Fiyatı
Add -H to the motor code	Traction sheave Ø320 Hardened	118 EUR
Add -MBR to the motor code	Manual Brake Release Device	234 EUR



## R1000 Regenerative Braking Package

- @ Package consists of R1000 Regenerative Braking Unit and 1% reactor
- @ 400VAC
- @ 3,5 - 300kW
- @ Power factor > 0.9 at full load
- @ Switching Method 120° block switching
- @ Load / Overload
  - 150% load for 30 s,
  - 100% load for 60 s with 25%
  - 80% continuous
- @ CE, UL, cUL, RoHS

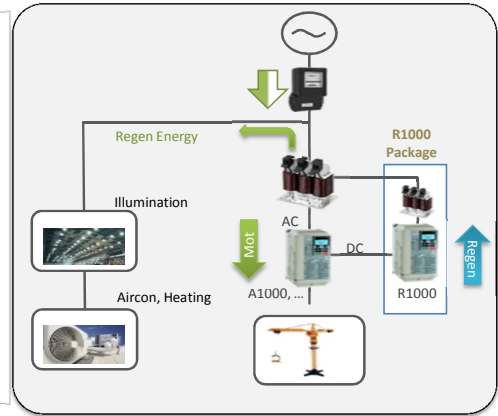

R1000 Regenerative Braking Package 400V incl. 1% Reactor in IP00

Ürün Kodu	Açıklama	Liste Fiyatı
R1KIT40003AAAAA	Regen Braking Unit R1000, 400 V, 3,5 kW, incl. 1% reactor, 0,20 kg copper	1.955 EUR
R1KIT40005AAAAA	Regen Braking Unit R1000, 400 V, 5,0 kW, incl. 1% reactor, 0,20 kg copper	1.995 EUR
R1KIT40007AAAAA	Regen Braking Unit R1000, 400 V, 7,0 kW, incl. 1% reactor, 0,30 kg copper	2.052 EUR
R1KIT40010AAAAA	Regen Braking Unit R1000, 400 V, 10 kW, incl. 1% reactor, 0,35 kg copper	2.272 EUR
R1KIT40014AAAAA	Regen Braking Unit R1000, 400 V, 14 kW, incl. 1% reactor, 0,40 kg copper	2.531 EUR
R1KIT40017AAAAA	Regen Braking Unit R1000, 400 V, 17 kW, incl. 1% reactor, 0,40 kg copper	2.951 EUR
R1KIT40020AAAAA	Regen Braking Unit R1000, 400 V, 20 kW, incl. 1% reactor, 0,45 kg copper	3.298 EUR
R1KIT40028AAAAA	Regen Braking Unit R1000, 400 V, 28 kW, incl. 1% reactor, 0,60 kg copper	3.977 EUR
R1KIT40035AAAAA	Regen Braking Unit R1000, 400 V, 35 kW, incl. 1% reactor, 0,65 kg copper	4.450 EUR
R1KIT40043AAAAA	Regen Braking Unit R1000, 400 V, 43 kW, incl. 1% reactor, 1,25 kg copper	5.216 EUR
R1KIT40053AAAAA	Regen Braking Unit R1000, 400 V, 53 kW, incl. 1% reactor, 1,25 kg copper	6.736 EUR
R1KIT40073AAAAA	Regen Braking Unit R1000, 400 V, 73 kW, incl. 1% reactor, 1,70 kg copper	8.104 EUR
R1KIT40105AAAAA	Regen Braking Unit R1000, 400 V, 105 kW, incl. 1% reactor, 2,00 kg copper	10.008 EUR
R1KIT40150AAAAA	Regen Braking Unit R1000, 400 V, 150 kW, incl. 1% reactor, 5,60 kg copper	11.030 EUR
R1KIT40210AAAAA	Regen Braking Unit R1000, 400 V, 210 kW, incl. 1% reactor, 6,30 kg copper	17.761 EUR
R1KIT40300AAAAA	Regen Braking Unit R1000, 400 V, 300 kW, incl. 1% reactor, 6,70 kg copper	20.043 EUR

Please note that we will add a copper fee to the above mentioned products on our order confirmation. The basis for the copper price which we will invoice is available on: <http://www.lme.com/copper.asp>. We use the following formula for the copper surcharge: ((3-month buyer\*exchange rate USD vs. EURO)/1000\*copper weight)

### Price-Adder for IP20 cover for 1% reactor in R1000-Kit

Ürün Kodu	Açıklama	Liste Fiyatı
R1KIT40003-0020XXBXX	Adder for IP20 cover for 1% reactor. R1000 Kit 3,5kW to 20kW	75 EUR
R1KIT40028-0043XXBXX	Adder for IP20 cover for 1% reactor. R1000 Kit 28kW to 43kW	80 EUR
R1KIT40053XXBXX	Adder for IP20 cover for 1% reactor. R1000 Kit 53kW	83 EUR
R1KIT40073-0105XXBXX	Adder for IP20 cover for 1% reactor. R1000 Kit 73kW to 105kW	94 EUR
R1KIT40150-0300XXBXX	Adder for IP20 cover for 1% reactor. R1000 Kit 150kW to 300kW	183 EUR

Ürün Kodu	Açıklama	Liste Fiyatı
LR3 40-4/2	AC Input Reactor 4% for R1000 package with AC4A0002. 2 Amp., 0,12 kg copper	52 EUR
LR3 40-4/4	AC Input Reactor 4% for R1000 package with AC4A0004, 4 Amp., 0,28 kg copper	57 EUR
LR3 40-4/6	AC Input Reactor 4% for R1000 package with AC4A0005, 6 Amp., 0,31 kg copper	65 EUR
LR3 40-4/10	AC Input Reactor 4% for R1000 package with AC4A0007, 0009, 10 Amp., 0,60 kg copper	84 EUR
LR3 40-4/16	AC Input Reactor 4% for R1000 package with AC4A0011. 16 Amp., 0,67 kg copper	93 EUR
LR3 40-4/20	AC Input Reactor 4% for R1000 package with AC4A0018. 20 Amp., 1,14 kg copper	113 EUR
LR3 40-4/25	AC Input Reactor 4% for R1000 package with AC4A0023. 25 Amp., 1,52 kg copper	158 EUR
LR3 40-4/45	AC Input Reactor 4% for R1000 package with AC4A0031, 0038. 45 Amp., 2,35 kg copper	222 EUR
LR3 40-4/63	AC Input Reactor 4% for R1000 package with AC4A0044, 0058. 63 Amp., 2,71 kg copper	258 EUR
LR3 40-4/70	AC Input Reactor 4% for R1000 package with AC4A0072. 70 Amp., 3,15 kg copper	315 EUR
LR3 40-4/90	AC Input Reactor 4% for R1000 package with AC4A0088. 90 Amp., 5,15 kg copper	520 EUR
LR3 40-4/115	AC Input Reactor 4% for R1000 package with AC4A0103. 115 Amp., 5,80 kg copper	685 EUR
LR3 40-4/160	AC Input Reactor 4% for R1000 package with AC4A0139, 0165. 160 Amp., 8,85 kg copper	794 EUR
LR3 40-4/200	AC Input Reactor 4% for R1000 package with AC4A0208. 200 Amp., 11,0 kg copper	842 EUR
LR3 40-4/250	AC Input Reactor 4% for R1000 package with AC4A0250. 250 Amp., 14,5 kg copper	923 EUR
LR3 40-4/300	AC Input Reactor 4% for R1000 package with AC4A0296. 300 Amp., 16,2 kg copper	1.134 EUR
LR3 40-4/400	AC Input Reactor 4% for R1000 package with AC4A0362, 0414. 400 Amp., 18,0 kg copper	1.231 EUR
LR3 40-4/500	AC Input Reactor 4% for R1000 package with AC4A0515. 500 Amp., 21,0 kg copper	1.347 EUR
LR3 40-4/710	AC Input Reactor 4% for R1000 package with AC4A0675. 710 Amp., 36,4 kg copper	2.368 EUR
LR3 40-4/1200	AC Input Reactor 4% for R1000 package with AC4A0930, 1200. 1200 Amp., 50,0 kg copper	5.779 EUR

Please note that we will add a copper fee to the above mentioned products on our order confirmation. The basis for the copper price which we will invoice is available on: <http://www.lme.com/copper.asp>. We use the following formular for the copper surcharge: ((3-month buyer\*exchange rate USD vs. EURO)/1000\*copper weight)

#### IP20 Box for AC Input Reactors 4 %

Ürün Kodu	Açıklama	Liste Fiyatı
IP20-BOX31	IP20 Box for AC input reactor type LR3 40-4/2	57 EUR
IP20-BOX32	IP20 Box for AC input reactor type LR3 40-4/4 to LR3 40-4/20	60 EUR
IP20-BOX33	IP20 Box for AC input reactor type LR3 40-4/25	62 EUR
IP20-BOX35	IP20 Box for AC input reactor type LR3 40-4/45	70 EUR
IP20-BOX36	IP20 Box for AC input reactor type LR3 40-4/63	74 EUR
IP20-BOX37	IP20 Box for AC input reactor type LR3 40-4/70	81 EUR
IP20-BOX39	IP20 Box for AC input reactor type LR3 40-4/90	137 EUR
IP20-BOX41	IP20 Box for AC input reactor type LR3 40-4/115 to LR3 40-4/200	158 EUR
IP20-BOX44	IP20 Box for AC input reactor type LR3 40-4/250 to LR3 40-4/400	222 EUR
IP20-BOX45	IP20 Box for AC input reactor type LR3 40-4/500	238 EUR
IP20-BOX46	IP20 Box for AC input reactor type LR3 40-4/710 to LR3 40-4/1200	253 EUR

#### EMC Filter for A1000

Ürün Kodu	Açıklama	Liste Fiyatı
HLD 110-500/8	EMC Filter for R1000 package with A1000 0002 to 0007	133 EUR
HLD 110-500/12	EMC Filter for R1000 package with A1000 0009	141 EUR
HLD 110-500/16	EMC Filter for R1000 package with A1000 0011	148 EUR
HLD 110-500/30	EMC Filter for R1000 package with A1000 0018, 0023	218 EUR
HLD 110-500/42	EMC Filter for R1000 package with A1000 0031, 0038	236 EUR

## Power Coordinating Reactor for L1000A in combination with R1000 - AC Input Reactor 8% IP00

Ürün Kodu	Açıklama	Liste Fiyatı
B 1103136	AC Input Reactor 8%, IP00, for R1000 package with L1000 0005 to 0009	129 EUR
B 1103138	AC Input Reactor 8%, IP00, for R1000 package with L1000 0015, 0018	170 EUR
B 1103139	AC Input Reactor 8%, IP00, for R1000 package with L1000 0024	243 EUR
B 1103140	AC Input Reactor 8%, IP00, for R1000 package with L1000 0031	284 EUR
B 1103141	AC Input Reactor 8%, IP00, for R1000 package with L1000 0039, 0045	513 EUR
B 1103142	AC Input Reactor 8%, IP00, for R1000 package with L1000 0060, 0075	671 EUR
B 0910013	AC Input Reactor 8%, IP00, for R1000 package with L1000 0091, 0112	931 EUR
B 1411053	AC Input Reactor 8%, IP00, for R1000 package with L1000 0150, 0180	2.449 EUR
B 0910013	AC Input Reactor 8%, IP00, for R1000 package with L1000 0216 <b>It is mandatory to use 2 pcs of the mentioned filter and switch them parallel.</b>	931 EUR

Please note that we will add a copper fee to the above mentioned products on our order confirmation. The basis for the copper price which we will invoice is available on: <http://www.lme.com/copper.asp>. We use the following formula for the copper surcharge: ((3-month buyer\*exchange rate USD vs. EURO)/1000\*copper weight)

## IP20 Box for AC Input Reactor

Ürün Kodu	Açıklama	Liste Fiyatı
IP20-BOX32	IP20 Box for Line Reactor type B 1103136	60 EUR
IP20-BOX35	IP20 Box for Line Reactor type B 1103138	70 EUR
IP20-BOX36	IP20 Box for Line Reactor type B 1103139	74 EUR
IP20-BOX37	IP20 Box for Line Reactor type B 1103140	81 EUR
IP20-BOX39	IP20 Box for Line Reactor type B 1103141, B 1103142	137 EUR
IP20-BOX42	IP20 Box for Line Reactor type B 0910013	179 EUR
IP20-BOX44	IP20 Box for Line Reactor type B 1411053	222 EUR

## EMC Filter

Ürün Kodu	Açıklama	Liste Fiyatı
HLD 110-500/8	EMC Filter for R1000 package with L1000 0005, 0006	133 EUR
HLD 110-500/12	EMC Filter for R1000 package with L1000 0009	141 EUR
HLD 110-500/16	EMC Filter for R1000 package with L1000 0015	148 EUR
HLD 110-500/30	EMC Filter for R1000 package with L1000 0018, 0024	218 EUR
HLD 110-500/42	EMC Filter for R1000 package with L1000 0031	236 EUR

## Options for R1000 Series

Ürün Kodu	Açıklama	Liste Fiyatı
AO-A3	2 additional Analog Output	133 EUR
DO-A3	Digital Output (6 open collector and 2 relays)	109 EUR
EUOP-V11001	IP54/65 Operator Frame	25 EUR
EZZ020642A	Operator Attachment IP 20 with screws	24 EUR
EZZ020642B	Operator Attachment IP 20 with nuts	18 EUR
EZZ020800B	Attachment for External Heatsink R1000 400V & 200V 3.5-7 kW	70 EUR
EZZ020800C	Attachment for External Heatsink R1000 400V & 200V 10-14 kW	77 EUR
EZZ020800D	Attachment for External Heatsink R1000 400V & 200V 17-28 kW	83 EUR
JVOP-180	LCD Operator 1000 Series	133 EUR
JVOP-181	Copy unit w/USB converter	232 EUR
JVOP-182	LED Operator 1000 Series	63 EUR
PS-A10HB	Power Supply Unit 24VDC (400V)	187 EUR
PS-A10LB	Power Supply Unit 24VDC (200V)	187 EUR
SI-T3	Comm. Interface Mechatrolink II	242 EUR
WV001-YEG	1m extension cable for remote Digital Operator	51 EUR
WV003-YEG	3m extension cable for remote Digital Operator	60 EUR



## D 1000 Converter Package

- @ Package consists of D1000 and LCL Filter Module
- optional: EMC Filter
- @ 200VAC & 400VAC
- @ 5.0 - 630kW (200VAC - 130kW)
- @ Input power factor of 0.99 min. (for rated operation)
- @ CE, RoHS compliant

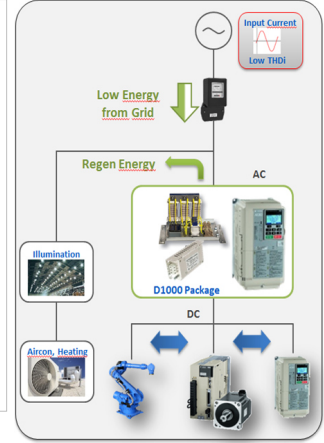

D1000 Converter Package 400V incl. LCL Filter Module in IP00 - without EMC Filter

Ürün Kodu	Açıklama	Liste Fiyatı
D1KIT40005ABAAB	Converter D1000, 400 V, 5.0 kW, incl. LCL Filter Module - without EMC Filter	2.616 EUR
D1KIT40010ABAAB	Converter D1000, 400 V, 10 kW, incl. LCL Filter Module - without EMC Filter	3.073 EUR
D1KIT40020ABAAB	Converter D1000, 400 V, 20 kW, incl. LCL Filter Module - without EMC Filter	4.127 EUR
D1KIT40030ABAAB	Converter D1000, 400 V, 30 kW, incl. LCL Filter Module - without EMC Filter	5.892 EUR
D1KIT40040ABAAB	Converter D1000, 400 V, 40 kW, incl. LCL Filter Module - without EMC Filter	6.191 EUR
D1KIT40060ABAAB	Converter D1000, 400 V, 60 kW, incl. LCL Filter Module - without EMC Filter	9.766 EUR
D1KIT40100ABAAB	Converter D1000, 400 V, 100 kW, incl. LCL Filter Module - without EMC Filter	12.097 EUR
D1KIT40130ABAAB	Converter D1000, 400 V, 130 kW, incl. LCL Filter Module - without EMC Filter	15.667 EUR
D1KIT40185ABAAB	Converter D1000, 400 V, 185 kW, incl. LCL Filter Module - without EMC Filter	20.342 EUR
D1KIT40270ABAAB	Converter D1000, 400 V, 270 kW, incl. LCL Filter Module - without EMC Filter	36.804 EUR
D1KIT40370ABAAB	Converter D1000, 400 V, 370 kW, incl. LCL Filter Module - without EMC Filter	45.942 EUR
D1KIT40630ABAAB	Converter D1000, 400 V, 630 kW, incl. LCL Filter Module - without EMC Filter	84.315 EUR

Protection class: D1000 ≤ 20kW = IP20; D1000 >20kW = IP00; LCL Filter Module = IP00

D1000 Converter Package 400V incl. LCL Filter Module and EMC Filter

Ürün Kodu	Açıklama	Liste Fiyatı
D1KIT40005AAAAB	Converter D1000, 400 V, 5.0 kW, incl. LCL Filter Module and EMC Filter	2.788 EUR
D1KIT40010AAAAB	Converter D1000, 400 V, 10 kW, incl. LCL Filter Module and EMC Filter	3.241 EUR
D1KIT40020AAAAB	Converter D1000, 400 V, 20 kW, incl. LCL Filter Module and EMC Filter	4.376 EUR
D1KIT40030AAAAB	Converter D1000, 400 V, 30 kW, incl. LCL Filter Module and EMC Filter	6.215 EUR
D1KIT40040AAAAB	Converter D1000, 400 V, 40 kW, incl. LCL Filter Module and EMC Filter	6.519 EUR
D1KIT40060AAAAB	Converter D1000, 400 V, 60 kW, incl. LCL Filter Module and EMC Filter	10.793 EUR
D1KIT40100AAAAB	Converter D1000, 400 V, 100 kW, incl. LCL Filter Module and EMC Filter	13.127 EUR
D1KIT40130AAAAB	Converter D1000, 400 V, 130 kW, incl. LCL Filter Module and EMC Filter	17.356 EUR
D1KIT40185AAAAB	Converter D1000, 400 V, 185 kW, incl. LCL Filter Module and EMC Filter	22.032 EUR
D1KIT40270AAAAB	Converter D1000, 400 V, 270 kW, incl. LCL Filter Module and EMC Filter	40.543 EUR
D1KIT40370AAAAB	Converter D1000, 400 V, 370 kW, incl. LCL Filter Module and EMC Filter	53.678 EUR
D1KIT40630AAAAB	Converter D1000, 400 V, 630 kW, incl. LCL Filter Module and EMC Filter	97.348 EUR

Protection class: D1000 ≤ 20kW = IP20; D1000 >20kW = IP00; LCL Filter Module = IP00; EMC Filter = IP00

Price-Adder for IP20 cover for LCL Filter Module in D1000-Kit (available up to 40kW only)

Ürün Kodu	Açıklama	Liste Fiyatı
D1KIT40005XXBXX	Adder for IP20 cover for LCL Filter Module. D1000 Kit 5kW	234 EUR
D1KIT40010-0020XXBXX	Adder for IP20 cover for LCL Filter Module. D1000 Kit 10kW to 20kW	243 EUR
D1KIT40030-0040XXBXX	Adder for IP20 cover for LCL Filter Module. D1000 Kit 30kW to 40kW	296 EUR



## D1000 Converter Package 200V incl. Input Reactor and Harmonic Filter - without EMC Filter

Ürün Kodu	Açıklama	Liste Fiyatı
D1KIT20005ABAAA	Converter D1000, 200 V, 5.0 kW, incl. Input Reactor and Harmonic Filter	3.545 EUR
D1KIT20010ABAAA	Converter D1000, 200 V, 10 kW, incl. Input Reactor and Harmonic Filter	4.314 EUR
D1KIT20020ABAAA	Converter D1000, 200 V, 20 kW, incl. Input Reactor and Harmonic Filter	6.376 EUR
D1KIT20030ABAAA	Converter D1000, 200 V, 30 kW, incl. Input Reactor and Harmonic Filter	8.819 EUR
D1KIT20050ABAAA	Converter D1000, 200 V, 50 kW, incl. Input Reactor and Harmonic Filter	12.272 EUR
D1KIT20065ABAAA	Converter D1000, 200 V, 65 kW, incl. Input Reactor and Harmonic Filter	16.629 EUR
D1KIT20090ABAAA	Converter D1000, 200 V, 90 kW, incl. Input Reactor and Harmonic Filter	19.651 EUR
D1KIT20130ABAAA	Converter D1000, 200 V, 130 kW, incl. Input Reactor and Harmonic Filter	28.089 EUR

Protection class: D1000 ≤ 20kW = IP20; D1000 >20kW = IP00; Input Reactor = IP00; Harmonic Filter = IP00

## Options for D1000 Series

Ürün Kodu	Açıklama	Liste Fiyatı
AO-A3	2 additional Analog Output	133 EUR
DO-A3	Digital Output (6 open collector and 2 relays)	109 EUR
EUOP-V11001	IP54/65 Operator Frame	25 EUR
EZZ020642A	Operator Attachment IP 20 with screws	24 EUR
EZZ020642B	Operator Attachment IP 20 with nuts	18 EUR
EZZ020800C	Heatsink external Attachment D1000 400V & 200V 0005kW & 0010kW	77 EUR
EZZ020800D	Heatsink external Attachment D1000 400V & 200V 0020kW	83 EUR
JVOP-180	LCD Operator 1000 Series (standard in A1000 included)	133 EUR
JVOP-181	Copy unit w/USB converter	232 EUR
JVOP-182	LED Operator 1000 Series	63 EUR
PS-A10HB	Power Supply Unit 24VDC (400V)	187 EUR
SI-T3	Comm. Interface Mechatrolink II	242 EUR
WV001-YEG	1m extension cable for remote Digital Operator	51 EUR
WV003-YEG	3m extension cable for remote Digital Operator	60 EUR



## U1000 Converter

- @ Input Voltage: 380 to 480 Vac, 200 to 240 Vac, -15 to +10% tolerance (500 Vac for models without built-in EMC filter)
- @ Input Frequency: 50/60 Hz, +/-3% tolerance
- @ Allowable Supply voltage Imbalance: < 2%
- @ Over Load: HD: 150% for 1 min. / ND: 120% for 1 m
- @ Carrier Frequency: 4 kHz (up to 10 kHz with derating)
- @ Max. Output Voltage: 87% of Vin (low harmonic mode) / 95% of Vin (high voltage mode)
- @ Max. Output Frequency: 400 Hz
- @ THDi at Input: < 5%
- @ Input Power Factor: > 0.98
- @ Degree of Protection: IP00; NEMA1 optional

### Matrix Converter U1000 400 VAC Three Phase - IP00 - with build-in EMC Filter (C2)

Ürün Kodu	Açıklama	Liste Fiyatı
CIMR-UC4E0011AAA	Converter U1000, 400 V, ND: 11 A, HD: 9,6 A, IP00, with EMC Filter (C2)	4.329 EUR
CIMR-UC4E0014AAA	Converter U1000, 400 V, ND: 14 A, HD: 11 A, IP00, with EMC Filter (C2)	4.528 EUR
CIMR-UC4E0021AAA	Converter U1000, 400 V, ND: 21 A, HD: 14 A, IP00, with EMC Filter (C2)	4.801 EUR
CIMR-UC4E0027AAA	Converter U1000, 400 V, ND: 27 A, HD: 21 A, IP00, with EMC Filter (C2)	5.117 EUR
CIMR-UC4E0034AAA	Converter U1000, 400 V, ND: 34 A, HD: 27 A, IP00, with EMC Filter (C2)	5.511 EUR
CIMR-UC4E0040AAA	Converter U1000, 400 V, ND: 40 A, HD: 34 A, IP00, with EMC Filter (C2)	7.674 EUR
CIMR-UC4E0052AAA	Converter U1000, 400 V, ND: 52 A, HD: 40 A, IP00, with EMC Filter (C2)	8.459 EUR
CIMR-UC4E0065AAA	Converter U1000, 400 V, ND: 65 A, HD: 52 A, IP00, with EMC Filter (C2)	9.522 EUR
CIMR-UC4E0077AAA	Converter U1000, 400 V, ND: 77 A, HD: 65 A, IP00, with EMC Filter (C2)	10.624 EUR
CIMR-UC4E0096AAA	Converter U1000, 400 V, ND: 96 A, HD: 77 A, IP00, with EMC Filter (C2)	12.353 EUR
CIMR-UC4E0124AAA	Converter U1000, 400 V, ND: 124 A, HD: 96 A, IP00, with EMC Filter (C2)	13.535 EUR
CIMR-UC4E0156AAA	Converter U1000, 400 V, ND: 156 A, HD: 124 A, IP00, with EMC Filter (C2)	20.661 EUR
CIMR-UC4E0180AAA	Converter U1000, 400 V, ND: 180 A, HD: 156 A, IP00, with EMC Filter (C2)	24.400 EUR
CIMR-UC4E0216AAA	Converter U1000, 400 V, ND: 216 A, HD: 180 A, IP00, with EMC Filter (C2)	32.030 EUR
CIMR-UC4E0240AAA	Converter U1000, 400 V, ND: 240 A, HD: 216 A, IP00, with EMC Filter (C2)	35.180 EUR
CIMR-UC4E0302AAA	Converter U1000, 400 V, ND: 302 A, HD: 240 A, IP00, with EMC Filter (C2)	40.766 EUR
CIMR-UC4E0361AAA	Converter U1000, 400 V, ND: 361 A, HD: 302 A, IP00, with EMC Filter (C2)	44.661 EUR
CIMR-UC4E0414AAA	Converter U1000, 400 V, ND: 414 A, HD: 361 A, IP00, with EMC Filter (C2)	48.990 EUR

### Matrix Converter U1000 400 VAC Three Phase - IP00 - without EMC filter

Ürün Kodu	Açıklama	Liste Fiyatı
CIMR-UC4A0011AAA	Converter U1000, 400 V, ND: 11 A, HD: 9,6 A, IP00	3.935 EUR
CIMR-UC4A0014AAA	Converter U1000, 400 V, ND: 14 A, HD: 11 A, IP00	4.130 EUR
CIMR-UC4A0021AAA	Converter U1000, 400 V, ND: 21 A, HD: 14 A, IP00	4.329 EUR
CIMR-UC4A0027AAA	Converter U1000, 400 V, ND: 27 A, HD: 21 A, IP00	4.719 EUR
CIMR-UC4A0034AAA	Converter U1000, 400 V, ND: 34 A, HD: 27 A, IP00	5.117 EUR
CIMR-UC4A0040AAA	Converter U1000, 400 V, ND: 40 A, HD: 34 A, IP00	6.491 EUR
CIMR-UC4A0052AAA	Converter U1000, 400 V, ND: 52 A, HD: 40 A, IP00	7.084 EUR
CIMR-UC4A0065AAA	Converter U1000, 400 V, ND: 65 A, HD: 52 A, IP00	8.068 EUR
CIMR-UC4A0077AAA	Converter U1000, 400 V, ND: 77 A, HD: 65 A, IP00	9.048 EUR
CIMR-UC4A0096AAA	Converter U1000, 400 V, ND: 96 A, HD: 77 A, IP00	10.505 EUR
CIMR-UC4A0124AAA	Converter U1000, 400 V, ND: 124 A, HD: 96 A, IP00	11.490 EUR
CIMR-UC4A0156AAA	Converter U1000, 400 V, ND: 156 A, HD: 124 A, IP00	17.116 EUR
CIMR-UC4A0180AAA	Converter U1000, 400 V, ND: 180 A, HD: 156 A, IP00	20.071 EUR
CIMR-UC4A0216AAA	Converter U1000, 400 V, ND: 216 A, HD: 180 A, IP00	26.047 EUR
CIMR-UC4A0240AAA	Converter U1000, 400 V, ND: 240 A, HD: 216 A, IP00	29.199 EUR
CIMR-UC4A0302AAA	Converter U1000, 400 V, ND: 302 A, HD: 240 A, IP00	32.779 EUR
CIMR-UC4A0361AAA	Converter U1000, 400 V, ND: 361 A, HD: 302 A, IP00	35.141 EUR
CIMR-UC4A0414AAA	Converter U1000, 400 V, ND: 414 A, HD: 361 A, IP00	38.290 EUR
CIMR-UC4A0477AAA	Converter U1000, 400 V, ND: 477 A, HD: 414 A, IP00 <sup>1</sup>	79.850 EUR
CIMR-UC4A0590AAA	Converter U1000, 400 V, ND: 590 A, HD: 477 A, IP00 <sup>1</sup>	83.008 EUR
CIMR-UC4A0720AAA	Converter U1000, 400 V, ND: 720 A, HD: 590 A, IP00 <sup>1 2</sup>	90.645 EUR
CIMR-UC4A0900AAA	Converter U1000, 400 V, ND: 900 A, HD: 720 A, IP00 <sup>1 2</sup>	91.156 EUR
CIMR-UC4A0930AAA	Converter U1000, 400 V, ND: 930 A, HD: 900 A, IP00 <sup>1 2</sup>	94.720 EUR

<sup>1</sup> External EMC filters must be used in order to keep CE compliance. Please refer to the related filters in the Options table.

## Matrix Converter U1000 200 VAC Three Phase - IP00 - with build-in EMC Filter (C2)

Ürün Kodu	Açıklama	Liste Fiyatı
CIMR-UC2E0028AAA	Converter U1000, 200 V, ND: 28 A, HD: 22 A, IP00, with EMC Filter (C2)	5.497 EUR
CIMR-UC2E0042AAA	Converter U1000, 200 V, ND: 42 A, HD: 28 A, IP00, with EMC Filter (C2)	7.686 EUR
CIMR-UC2E0054AAA	Converter U1000, 200 V, ND: 54 A, HD: 42 A, IP00, with EMC Filter (C2)	8.451 EUR
CIMR-UC2E0068AAA	Converter U1000, 200 V, ND: 68 A, HD: 54 A, IP00, with EMC Filter (C2)	9.518 EUR
CIMR-UC2E0081AAA	Converter U1000, 200 V, ND: 81 A, HD: 68 A, IP00, with EMC Filter (C2)	10.640 EUR
CIMR-UC2E0104AAA	Converter U1000, 200 V, ND: 104 A, HD: 81 A, IP00, with EMC Filter (C2)	12.367 EUR
CIMR-UC2E0130AAA	Converter U1000, 200 V, ND: 130 A, HD: 104 A, IP00, with EMC Filter (C2)	13.542 EUR
CIMR-UC2E0154AAA	Converter U1000, 200 V, ND: 154 A, HD: 130 A, IP00, with EMC Filter (C2)	20.667 EUR
CIMR-UC2E0192AAA	Converter U1000, 200 V, ND: 192 A, HD: 154 A, IP00, with EMC Filter (C2)	24.381 EUR
CIMR-UC2E0248AAA	Converter U1000, 200 V, ND: 248 A, HD: 192 A, IP00, with EMC Filter (C2)	32.016 EUR

## Matrix Converter U1000 200 VAC Three Phase - IP00 - without EMC filter

Ürün Kodu	Açıklama	Liste Fiyatı
CIMR-UC2A0028AAA	Converter U1000, 200 V, ND: 28 A, HD: 22 A, IP00	5.143 EUR
CIMR-UC2A0042AAA	Converter U1000, 200 V, ND: 42 A, HD: 28 A, IP00	6.515 EUR
CIMR-UC2A0054AAA	Converter U1000, 200 V, ND: 54 A, HD: 42 A, IP00	7.073 EUR
CIMR-UC2A0068AAA	Converter U1000, 200 V, ND: 68 A, HD: 54 A, IP00	8.041 EUR
CIMR-UC2A0081AAA	Converter U1000, 200 V, ND: 81 A, HD: 68 A, IP00	9.060 EUR
CIMR-UC2A0104AAA	Converter U1000, 200 V, ND: 104 A, HD: 81 A, IP00	10.484 EUR
CIMR-UC2A0130AAA	Converter U1000, 200 V, ND: 130 A, HD: 104 A, IP00	11.504 EUR
CIMR-UC2A0154AAA	Converter U1000, 200 V, ND: 154 A, HD: 130 A, IP00	17.104 EUR
CIMR-UC2A0192AAA	Converter U1000, 200 V, ND: 192 A, HD: 154 A, IP00	20.054 EUR
CIMR-UC2A0248AAA	Converter U1000, 200 V, ND: 248 A, HD: 192 A, IP00	26.060 EUR

## Options for U1000 Series

Ürün Kodu	Açıklama	Liste Fiyatı
AI-A3	Analog Input card (3 inputs)	179 EUR
AO-A3	2 additional Analog Output	133 EUR
B84143B1000S080	External EMC Line-Filter for U1000 CIMR-UC4A0477, 0590. EN61800-3 Class C2, 1000 Amp.	3.226 EUR
B84143B1600S080	External EMC Line-Filter for U1000 CIMR-UC4A0720 to 0930. EN61800-3 Class C2, 1600 Amp.	4.919 EUR
DI-A3	Digital Input (BCD Code)	109 EUR
DO-A3	Digital Output (6 open collector 2 relais)	109 EUR
EUOP-V11001	IP54/65 Operator Frame	25 EUR
EUJ711830	External LCL Filter for U1000 CIMR-UC4A0720.	31.901 EUR
EUJ711840	External LCL Filter for U1000 CIMR-UC4A0900.	32.802 EUR
EUJ711850	External LCL Filter for U1000 CIMR-UC4A0930.	33.701 EUR
EZZ020642A	Operator Attachment IP 20 with screws	24 EUR
EZZ020642B	Operator Attachment IP 20 with nuts	18 EUR
EZZ022706A	External Heatsink Mounting Kit for Converter U1000 400V 11A, 14A, 21A, 27A, 34A. 200V 28A.	35 EUR
EZZ022706B	External Heatsink Mounting Kit for Converter U1000 400V 40A, 52A, 65A, 77A. 200V 42A, 54A, 68A, 81A.	35 EUR
EZZ022706C	External Heatsink Mounting Kit for Converter U1000 400V 96A, 124A. 200V 104A, 130A.	70 EUR
EZZ022706D	External Heatsink Mounting Kit for Converter U1000 400V 156A, 180A. 200V 154A, 192A.	127 EUR
EZZ022706E	External Heatsink Mounting Kit for Converter U1000 400V 216A, 240A. 200V 248A.	70 EUR
EZZ022706F	External Heatsink Mounting Kit for Converter U1000 400V 302A, 361A, 414A	89 EUR
EZZ022745A	NEMA1 Kit for Converter U1000 400V 11A, 14A, 21A, 27A, 34A. 200V 28A.	124 EUR
EZZ022745B	NEMA1 Kit for Converter U1000 400V 40A, 52A, 65A, 77A. 200V 42A, 54A, 68A, 81A.	165 EUR
EZZ022745C	NEMA1 Kit for Converter U1000 400V 96A, 124A. 200V 104A, 130A.	183 EUR
EZZ022745D	NEMA1 Kit for Converter U1000 400V 156A, 180A. 200V 154A, 192A.	370 EUR
EZZ022745E	NEMA1 Kit for Converter U1000 400V 216A, 240A. 200V 248A.	386 EUR
EZZ022745F	NEMA1 Kit for Converter U1000 400V 302A, 361A, 414A	531 EUR
JVOP-180	LCD Operator 1000 Series (standard in U1000 included)	133 EUR
JVOP-181	Copy unit w/USB converter	232 EUR
JVOP-182	LED Operator 1000 Series	63 EUR
MANUAL	Technical Manual - Printed Version - for U1000 Series	64 EUR
PS-U10H	PS-U10H OP PWR.SPLY-CARD,24V,400V	203 EUR
PG-B3	Open Collector PG-Interface 50kHz	104 EUR
PG-X3	Line Driver PG-Interface 300kHz	104 EUR
PG-F3	EnDat Encoder Interface Card	207 EUR
SI-C3	Comm. Interface U1000 CCLink	259 EUR
SI-EL3	Comm. Interface U1000 Powerlink	558 EUR
SI-EN3	Comm.Interface U1000 EtherNet IP	333 EUR
SI-EN3D	Comm. Interface U1000 Dual Port EtherNet IP	455 EUR
SI-EM3	Comm.Interface U1000 Modbus TCP	356 EUR
SI-EM3D	Comm.Interface U1000 Dual Port Modbus TCP	534 EUR
SI-EP3	Comm.Interface U1000 ProfiNet	498 EUR
EUOP-SI-ES3	Comm. Interface U1000 EtherCAT	351 EUR
SI-ES3	Comm. Interface A1000 EtherCAT *1	357 EUR
SI-N3	Comm. Interface U1000 DeviceNET	169 EUR
SI-P3	Comm. Interface U1000 ProfibusDP	361 EUR
SI-S3	Comm. Interface U1000 CANopen	187 EUR
SI-T3	Comm. Interface U1000 Mechatrolink II	242 EUR
WV001-YEG	1m extension cable for remote Digital Operator	51 EUR
WV003-YEG	3m extension cable for remote Digital Operator	60 EUR

\*1: Note: The SI-ES option card will replace the EUOP-SI-ES3 card. Both cards will be available in parallel for a certain period of time. On the SI-ES3 card a few functions work in a different way than on the EUOP-SI-ES3 card. Therefore we recommend:

- not to mix SI-ES3 and EUOP-SI-ES3 cards in one project.
- use the SI-ES3, NOT EUOP-SI-ES3 for new projects.

Information on compatibility can be obtained from our technical support.



## V1000 MMD - Decentral Inverter

- @ 1,1kW - 4kW (HD)
- @ Basic specifications from V1000 inverter
- @ IP65 protection class
- @ C1 EMC filter integrated
- @ Integrated control panel with large buttons
- @ PLC – functionality directly programmable in the Inverter
- @ Mountable on different motors through adapter
- @ Wallmount possible
- @ All Fieldbus from V1000 series are applicable



### V1000 MMD - Decentral Inverter with built in Keypad

Ürün Kodu	Açıklama	Liste Fiyatı
V1MCA40004AAAAAAAA	V1000 MMD, 4 A, 1.1 kW (HD), with built in Keypad	1.294 EUR
V1MCA40005AAAAAAAA	V1000 MMD, 5 A, 1.5 kW (HD), with built in Keypad	1.395 EUR
V1MCA40007AAAAAAAA	V1000 MMD, 7 A, 2.2 kW (HD), with built in Keypad	1.411 EUR
V1MCA40009AAAAAAAA	V1000 MMD, 9 A, 3 kW (HD), with built in Keypad	1.399 EUR
V1MCA40011AAAAAAAA	V1000 MMD, 11 A, 4 kW (HD), with built in Keypad	1.478 EUR

A mounting collar is a mandatory accessory for fixing the inverter to a wall or a motor.

### V1000 MMD - Decentral Inverter without Keypad

Ürün Kodu	Açıklama	Liste Fiyatı
V1MCA40004BAAAAAAAA	V1000 MMD, 4 A, 1.1 kW (HD), without Keypad	1.156 EUR
V1MCA40005BAAAAAAAA	V1000 MMD, 5 A, 1.5 kW (HD), without Keypad	1.258 EUR
V1MCA40007BAAAAAAAA	V1000 MMD, 7 A, 2.2 kW (HD), without Keypad	1.272 EUR
V1MCA40009BAAAAAAAA	V1000 MMD, 9 A, 3 kW (HD), without Keypad	1.261 EUR
V1MCA40011BAAAAAAAA	V1000 MMD, 11 A, 4 kW (HD), without Keypad	1.338 EUR

A mounting collar is a mandatory accessory for fixing the inverter to a wall or a motor.

### Variants of V1000 MMD

Ürün Kodu	Açıklama	Liste Fiyatı
V1MCA4xxxxxBxxxxx	Adder for Potentiometer/switch left	147 EUR
V1MCA4xxxxxCxxxxx	Adder for Potentiometer/switch right	147 EUR

### Options for V1000 MMD

Ürün Kodu	Açıklama	Liste Fiyatı
EUOP-V11015	Mounting Collar for SPRiPM Motor	105 EUR
EUOP-V11016	MMD Wall Mount Kit	203 EUR
EUOP-V11017	Mounting Collar for Motor (mounting holes for terminal box to be drilled by customer)	105 EUR



## SPRIpM iE4 Motor

- @ 1,5 - 4 kW
- @ 1.500 rpm or 3.000 rpm
- @ B3 foot mount or B5 flange mount motors
- @ Degree of Protection: IP55

### SPRIpM iE4 Motor, 1.500 rpm, B3 foot mount

Ürün Kodu	Açıklama	Liste Fiyatı
M071M015BJA00000A0000C	SPRIpM Motor, 1,5 kW, 1.500 rpm, B3 foot mount, use with CIMR-V1MCA40005 drive	468 EUR
M080M022BJA00000A0000C	SPRIpM Motor, 2,2 kW, 1.500 rpm, B3 foot mount, use with CIMR-V1MCA40007 drive	654 EUR
M090L040BJA00000A0000C	SPRIpM Motor, 4,0 kW, 1.500 rpm, B3 foot mount, use with CIMR-V1MCA40011 drive	877 EUR

### SPRIpM iE4 Motor, 3.000 rpm, B3 foot mount

Ürün Kodu	Açıklama	Liste Fiyatı
M071M015BMA00000A0000C	SPRIpM Motor, 1,5 kW, 3.000 rpm, B3 foot mount, use with CIMR-V1MCA40005 drive	440 EUR
M071M022BMA00000A0000C	SPRIpM Motor, 2,2 kW, 3.000 rpm, B3 foot mount, use with CIMR-V1MCA40007 drive	448 EUR
M071M040BMA00000A0000C	SPRIpM Motor, 4,0 kW, 3.000 rpm, B3 foot mount, use with CIMR-V1MCA40011 drive	529 EUR

### SPRIpM iE4 Motor, 1.500 rpm, B5 flange mount

Ürün Kodu	Açıklama	Liste Fiyatı
M071M015BJC00000A0000C	SPRIpM Motor, 1,5 kW, 1.500 rpm, B5 flange mount, use with CIMR-V1MCA40005 drive	494 EUR
M080M022BJC00000A0000C	SPRIpM Motor, 2,2 kW, 1.500 rpm, B5 flange mount, use with CIMR-V1MCA40007 drive	681 EUR
M090L040BJC00000A0000C	SPRIpM Motor, 4,0 kW, 1.500 rpm, B5 flange mount, use with CIMR-V1MCA40011 drive	911 EUR

### SPRIpM iE4 Motor, 3.000 rpm, B5 flange mount

Ürün Kodu	Açıklama	Liste Fiyatı
M071M015BMC00000A0000C	SPRIpM Motor, 1,5 kW, 3.000 rpm, B5 flange mount, use with CIMR-V1MCA40005 drive	462 EUR
M071M022BMC00000A0000C	SPRIpM Motor, 2,2 kW, 3.000 rpm, B5 flange mount, use with CIMR-V1MCA40007 drive	475 EUR
M071M040BMC00000A0000C	SPRIpM Motor, 4,0 kW, 3.000 rpm, B5 flange mount, use with CIMR-V1MCA40011 drive	554 EUR

### Options for V1000 Series

Ürün Kodu	Açıklama	Liste Fiyatı
JVOP-181	Copy unit w/USB converter	232 EUR
MANUAL	Technical Manual - Printed Version - for V1000 Series	64 EUR
SI-C3/V	Comm.Interface V1000 CC Link	280 EUR
SI-EL3/V	Comm.Interface V1000 Powerlink	579 EUR
SI-EN3/V	Comm.Interface V1000 EtherNet IP	369 EUR
SI-EN3D/V	Comm. Interface V1000 Dual Port EtherNet IP	484 EUR
SI-EM3/V	Comm.Interface V1000 Modbus TCP	365 EUR
SI-EP3/V	Comm.Interface V1000 ProfiNet	556 EUR
EUOP-SI-ES3/V	Comm.Interface V1000 EtherCAT	467 EUR
SI-ES3/V	Comm.Interface V1000 EtherCAT *1	380 EUR
SI-N3/V	Comm.Interface V1000 DeviceNet	196 EUR
SI-P3/V	Comm.Interface V1000 Profibus DP	344 EUR
SI-S3/V	Comm.Interface V1000 CANopen	214 EUR
SI-T3/V	Comm.Interface V1000 Mechatrolink II	228 EUR
SI-ET3/V	Comm.Interface V1000 Mechatrolink III	351 EUR

\*1: Note: The SI-ES/V option card will replace the EUOP-SI-ES3/V card. Both cards will be available in parallel for a certain period of time. On the SI-ES3/V card a few functions work in a different way than on the EUOP-SI-ES3/V card. Therefore we recommend:

- a) not to mix SI-ES3/V and EUOP-SI-ES3/V cards in one project.
- b) use the SI-ES3/V, NOT EUOP-SI-ES3/V for new projects.

Information on compatibility can be obtained from our technical support.



## SPRiPM Package - V1000

- @ Package consists of SPRiPM Motor, Inverter V1000, EMC Filter
- @ Output power: 1,5 - 18,5 kW, Motor speed: 1.500 rpm / 3.000 rpm
- @ Voltage 400 V
- @ Motor frame sizes: 71 to 132 according IEC regulation, Motor protection IP55
- @ Packages available with IP20 or IP66 V1000 inverters
- @ Efficiency: Higher than requirements of IE4, Motor mounting: B3 / B5

### SPRiPM Package (Motor & Inverter & EMC Filter), 1.500 rpm, foot mount B3 motor - with IP20/NEMA1 inverter

Ürün Kodu	Açıklama	Liste Fiyatı
SPVB4A1P5BNAAAAAAAAAAAA	SPRiPM Package 1.500 rpm, 1,5 kW	1.112 EUR
SPVB4A2P2BNAAAAAAAAAAAA	SPRiPM Package 1.500 rpm, 2,2 kW	1.345 EUR
SPVB4A4P0BNAAAAAAAAAAAA	SPRiPM Package 1.500 rpm, 4,0 kW	1.775 EUR
SPVF4A5P5BNAAAAAAAAAAAA	SPRiPM Package 1.500 rpm, 5,5 kW	2.209 EUR
SPVF4A7P5BNCAAAAAAAAAAAAA	SPRiPM Package 1.500 rpm, 7,5 kW	2.571 EUR
SPVF4A011BNAAAAAAAAAAAA	SPRiPM Package 1.500 rpm, 11 kW	4.517 EUR
SPVF4A015BNAAAAAAAAAAAA	SPRiPM Package 1.500 rpm, 15 kW	5.063 EUR
SPVF4A018BNAAAAAAAAAAAA	SPRiPM Package 1.500 rpm, 18,5 kW	5.238 EUR

### SPRiPM Package (Motor & Inverter & EMC Filter), 3.000 rpm, foot mount B3 motor - with IP20/NEMA1 inverter

Ürün Kodu	Açıklama	Liste Fiyatı
SPVB4A1P5ANAAAAAAAAAAAA	SPRiPM Package 3.000 rpm, 1,5 kW	1.084 EUR
SPVB4A2P2ANAAAAAAAAAAAA	SPRiPM Package 3.000 rpm, 2,2 kW	1.130 EUR
SPVB4A4P0ANAAAAAAAAAAAA	SPRiPM Package 3.000 rpm, 4,0 kW	1.407 EUR
SPVF4A5P5ANAAAAAAAAAAAA	SPRiPM Package 3.000 rpm, 5,5 kW	1.933 EUR
SPVF4A7P5ANAAAAAAAAAAAA	SPRiPM Package 3.000 rpm, 7,5 kW	2.257 EUR
SPVF4A011ANAAAAAAAAAAAA	SPRiPM Package 3.000 rpm, 11 kW	2.662 EUR
SPVF4A015ANCAAAAAAAAAAAAA	SPRiPM Package 3.000 rpm, 15 kW	3.340 EUR
SPVF4A018ANAAAAAAAAAAAA	SPRiPM Package 3.000 rpm, 18,5 kW	4.891 EUR

### SPRiPM Package (Motor & Inverter & EMC Filter), 1.500 rpm, flange mount B5 motor - with IP20/NEMA1 inverter

Ürün Kodu	Açıklama	Liste Fiyatı
SPVB4A1P5BNBAAAAAAAAAAAA	SPRiPM Package 1.500 rpm, 1,5 kW	1.140 EUR
SPVB4A2P2BNBAAAAAAAAAAAA	SPRiPM Package 1.500 rpm, 2,2 kW	1.376 EUR
SPVB4A4P0BNBAAAAAAAAAAAA	SPRiPM Package 1.500 rpm, 4,0 kW	1.811 EUR
SPVF4A5P5BNBAAAAAAAAAAAA	SPRiPM Package 1.500 rpm, 5,5 kW	2.320 EUR
SPVF4A7P5BNDBAAAAAAAAAAAA	SPRiPM Package 1.500 rpm, 7,5 kW	2.627 EUR
SPVF4A011BNBAAAAAAAAAAAA	SPRiPM Package 1.500 rpm, 11 kW	4.587 EUR
SPVF4A015BNBAAAAAAAAAAAA	SPRiPM Package 1.500 rpm, 15 kW	5.137 EUR
SPVF4A018BNBAAAAAAAAAAAA	SPRiPM Package 1.500 rpm, 18,5 kW	5.314 EUR

### SPRiPM Package (Motor & Inverter & EMC Filter), 3.000 rpm, flange mount B5 motor - with IP20/NEMA1 inverter

Ürün Kodu	Açıklama	Liste Fiyatı
SPVB4A1P5ANBAAAAAAAAAAAA	SPRiPM Package 3.000 rpm, 1,5 kW	1.104 EUR
SPVB4A2P2ANBAAAAAAAAAAAA	SPRiPM Package 3.000 rpm, 2,2 kW	1.157 EUR
SPVB4A4P0ANBAAAAAAAAAAAA	SPRiPM Package 3.000 rpm, 4,0 kW	1.434 EUR
SPVF4A5P5ANBAAAAAAAAAAAA	SPRiPM Package 3.000 rpm, 5,5 kW	1.973 EUR
SPVF4A7P5ANBAAAAAAAAAAAA	SPRiPM Package 3.000 rpm, 7,5 kW	2.315 EUR
SPVF4A011ANBAAAAAAAAAAAA	SPRiPM Package 3.000 rpm, 11 kW	2.718 EUR
SPVF4A015ANDAAAAAAAAAAAA	SPRiPM Package 3.000 rpm, 15 kW	3.396 EUR
SPVF4A018ANBAAAAAAAAAAAA	SPRiPM Package 3.000 rpm, 18,5 kW	5.329 EUR



**SPRIIP Package (Motor & Inverter & EMC Filter), 1.500 rpm, foot mount B3 motor - with IP66 inverter**

Ürün Kodu	Açıklama	Liste Fiyatı
SPVH4A1P5BNAAAAAAAAAAAA	SPRIIP Package 1.500 rpm, 1,5 kW	1.542 EUR
SPVH4A2P2BNAAAAAAAAAAAA	SPRIIP Package 1.500 rpm, 2,2 kW	1.768 EUR
SPVH4A4P0BNAAAAAAAAAAAA	SPRIIP Package 1.500 rpm, 4,0 kW	2.189 EUR
SPVH4A5P5BNAAAAAAAAAAAA	SPRIIP Package 1.500 rpm, 5,5 kW	3.670 EUR
SPVH4A7P5BNCAAAAAAAAAAAAA	SPRIIP Package 1.500 rpm, 7,5 kW	3.964 EUR
SPVH4A011BNAAAAAAAAAAAA	SPRIIP Package 1.500 rpm, 11 kW	5.704 EUR
SPVH4A015BNAAAAAAAAAAAA	SPRIIP Package 1.500 rpm, 15 kW	6.163 EUR
SPVH4A018BNAAAAAAAAAAAA	SPRIIP Package 1.500 rpm, 18,5 kW	6.335 EUR

**SPRIIP Package (Motor & Inverter & EMC Filter), 3.000 rpm, foot mount B3 motor - with IP66 inverter**

Ürün Kodu	Açıklama	Liste Fiyatı
SPVH4A1P5ANAAAAAAAAAAAA	SPRIIP Package 3.000 rpm, 1,5 kW	1.512 EUR
SPVH4A2P2ANAAAAAAAAAAAA	SPRIIP Package 3.000 rpm, 2,2 kW	1.552 EUR
SPVH4A4P0ANAAAAAAAAAAAA	SPRIIP Package 3.000 rpm, 4,0 kW	1.824 EUR
SPVH4A5P5ANAAAAAAAAAAAA	SPRIIP Package 3.000 rpm, 5,5 kW	3.393 EUR
SPVH4A7P5ANAAAAAAAAAAAA	SPRIIP Package 3.000 rpm, 7,5 kW	3.650 EUR
SPVH4A011ANAAAAAAAAAAAA	SPRIIP Package 3.000 rpm, 11 kW	3.849 EUR
SPVH4A015ANCAAAAAAAAAAAAA	SPRIIP Package 3.000 rpm, 15 kW	4.435 EUR
SPVH4A018ANAAAAAAAAAAAA	SPRIIP Package 3.000 rpm, 18,5 kW	5.990 EUR

**SPRIIP Package (Motor & Inverter & EMC Filter), 1.500 rpm, flange mount B5 motor - with IP66 inverter**

Ürün Kodu	Açıklama	Liste Fiyatı
SPVH4A1P5BNBAAAAAAAAAAAA	SPRIIP Package 1.500 rpm, 1,5 kW	1.568 EUR
SPVH4A2P2BNBAAAAAAAAAAAA	SPRIIP Package 1.500 rpm, 2,2 kW	1.798 EUR
SPVH4A4P0BNBAAAAAAAAAAAA	SPRIIP Package 1.500 rpm, 4,0 kW	2.226 EUR
SPVH4A5P5BNBAAAAAAAAAAAA	SPRIIP Package 1.500 rpm, 5,5 kW	3.728 EUR
SPVH4A7P5BNDAAAAAAAAAAAA	SPRIIP Package 1.500 rpm, 7,5 kW	4.017 EUR
SPVH4A011BNBAAAAAAAAAAAA	SPRIIP Package 1.500 rpm, 11 kW	5.772 EUR
SPVH4A015BNBAAAAAAAAAAAA	SPRIIP Package 1.500 rpm, 15 kW	6.234 EUR
SPVH4A018BNBAAAAAAAAAAAA	SPRIIP Package 1.500 rpm, 18,5 kW	6.410 EUR

**SPRIIP Package (Motor & Inverter & EMC Filter), 3.000 rpm, flange mount B5 motor - with IP66 inverter**

Ürün Kodu	Açıklama	Liste Fiyatı
SPVH4A1P5ANBAAAAAAAAAAAA	SPRIIP Package 3.000 rpm, 1,5 kW	1.535 EUR
SPVH4A2P2ANBAAAAAAAAAAAA	SPRIIP Package 3.000 rpm, 2,2 kW	1.578 EUR
SPVH4A4P0ANBAAAAAAAAAAAA	SPRIIP Package 3.000 rpm, 4,0 kW	1.851 EUR
SPVH4A5P5ANBAAAAAAAAAAAA	SPRIIP Package 3.000 rpm, 5,5 kW	3.434 EUR
SPVH4A7P5ANBAAAAAAAAAAAA	SPRIIP Package 3.000 rpm, 7,5 kW	3.704 EUR
SPVH4A011ANBAAAAAAAAAAAA	SPRIIP Package 3.000 rpm, 11 kW	3.906 EUR
SPVH4A015ANDAAAAAAAAAAAA	SPRIIP Package 3.000 rpm, 15 kW	4.494 EUR
SPVH4A018ANBAAAAAAAAAAAA	SPRIIP Package 3.000 rpm, 18,5 kW	6.058 EUR



## Options for V1000 Series

Ürün Kodu	Açıklama	Liste Fiyatı
EZZ020568D	Heatsink external Attachment V1000, T1000V 230V 10A / 200V 10A, 12A / 400V 5A, 7A, 9A	49 EUR
EZZ020568E	Heatsink external Attachment V1000, T1000V 230V 12A / 200V 20A / 400V 11A	53 EUR
EZZ020568H	Heatsink external Attachment V1000, T1000V 230V 30A, 40A / 400V 18A, 23A	67 EUR
EZZ020568J	Heatsink external Attachment V1000, T1000V 200V 56A / 400V 31A, 38A	74 EUR
EZZ08122B	DIN Rail Attachment V1000 400V 1A, 2A, 4A, 5A, 7A, 9A	14 EUR
EZZ08122C	DIN Rail Attachment V1000 400V 11A	14 EUR
JVOP-180	LCD Operator 1000 Series	133 EUR
JVOP-181	Copy unit w/USB converter	232 EUR
JVOP-182	LED Operator 1000 Series	63 EUR
PS-V10S	ext.24V power supply upto 4kW	133 EUR
PS-V10M	ext.24V power supply 5,5-15kW	137 EUR
SI-C3/V	Comm.Interface V1000 CC Link	280 EUR
SI-EL3/V	Comm.Interface V1000 Powerlink	579 EUR
SI-EN3/V	Comm.Interface V1000 EtherNet IP	369 EUR
SI-EM3/V	Comm.Interface V1000 Modbus TCP	365 EUR
SI-EP3/V	Comm.Interface V1000 ProfiNet	556 EUR
EUOP-SI-ES3/V	Comm.Interface V1000 EtherCat	467 EUR
SI-ES3/V	Comm.Interface V1000 EtherCAT *1	380 EUR
SI-N3/V	Comm.Interface V1000 DeviceNet	196 EUR
SI-P3/V	Comm.Interface V1000 Profibus DP	344 EUR
SI-S3/V	Comm.Interface V1000 CANopen	214 EUR
SI-T3/V	Comm.Interface V1000 Mechatrolink II	228 EUR
WV001-YEG	1m extension cable for remote Digital Operator	51 EUR
WV003-YEG	3m extension cable for remote Digital Operator	60 EUR

\*1: Note: The SI-ES/V option card will replace the EUOP-SI-ES3/V card. Both cards will be available in parallel for a certain period of time. On the SI-ES3/V card a few functions work in a different way than on the EUOP-SI-ES3/V card. Therefore we recommend:

- not to mix SI-ES3/V and EUOP-SI-ES3/V cards in one project.
- use the SI-ES3/V, NOT EUOP-SI-ES3/V for new projects.

Information on compatibility can be obtained from our technical support.



## SPRI PM Package - A1000

- @ Package consists of SPRI PM Motor, Inverter A1000, EMC Filter
- @ Output power: 1,5 - 45,0 kW, Motor speed: 1.500 rpm / 3.000 rpm
- @ Voltage 400 V
- @ Motor frame sizes: 71 to 180 according IEC regulation, Motor protection IP55
- @ Packages available in IP00/NEMA1/IP54 A1000 inverters
- @ Efficiency: Higher than requirements of IE4, Motor mounting: B3 / B5
- @ Motor regulations: CE, RoHS

### SPRI PM Package (Motor & Inverter & EMC Filter), 1.500 rpm, foot mount B3 motor - with IP20/NEMA1 inverter

Ürün Kodu	Açıklama	Liste Fiyatı
SPAF4A1P5BNAAAAAAAAAA	SPRI PM Package 1.500 rpm, 1,5 kW	1.383 EUR
SPAF4A2P2BNAAAAAAAAAA	SPRI PM Package 1.500 rpm, 2,2 kW	1.629 EUR
SPAF4A4P0BNAAAAAAAAAA	SPRI PM Package 1.500 rpm, 4,0 kW	2.006 EUR
SPAF4A5P5BNAAAAAAAAAA	SPRI PM Package 1.500 rpm, 5,5 kW	2.517 EUR
SPAF4A7P5BNCAAAAAAAAAA	SPRI PM Package 1.500 rpm, 7,5 kW	2.981 EUR
SPAF4A011BNAAAAAAAAAA	SPRI PM Package 1.500 rpm, 11 kW	4.820 EUR
SPAF4A015BNAAAAAAAAAA	SPRI PM Package 1.500 rpm, 15 kW	5.394 EUR
SPAF4A018BNAAAAAAAAAA	SPRI PM Package 1.500 rpm, 18,5 kW	5.788 EUR
SPAA4A022BNAAAAAAAAAA	SPRI PM Package 1.500 rpm, 22 kW	8.710 EUR
SPAA4A030BNAAAAAAAAAA	SPRI PM Package 1.500 rpm, 30 kW	10.096 EUR
SPAA4A037BNAAAAAAAAAA	SPRI PM Package 1.500 rpm, 37 kW	12.039 EUR
SPAA4A045BNAAAAAAAAAA	SPRI PM Package 1.500 rpm, 45 kW	14.593 EUR

### SPRI PM Package (Motor & Inverter & EMC Filter), 3.000 rpm, foot mount B3 motor - with IP00/NEMA1 inverter

Ürün Kodu	Açıklama	Liste Fiyatı
SPAF4A1P5ANAAAAAAAAAA	SPRI PM Package 3.000 rpm, 1,5 kW	1.353 EUR
SPAF4A2P2ANAAAAAAAAAA	SPRI PM Package 3.000 rpm, 2,2 kW	1.413 EUR
SPAF4A4P0ANAAAAAAAAAA	SPRI PM Package 3.000 rpm, 4,0 kW	1.640 EUR
SPAF4A5P5ANAAAAAAAAAA	SPRI PM Package 3.000 rpm, 5,5 kW	2.239 EUR
SPAF4A7P5ANAAAAAAAAAA	SPRI PM Package 3.000 rpm, 7,5 kW	2.667 EUR
SPAF4A011ANAAAAAAAAAA	SPRI PM Package 3.000 rpm, 11 kW	2.965 EUR
SPAF4A015ANCAAAAAAAAAA	SPRI PM Package 3.000 rpm, 15 kW	3.667 EUR
SPAF4A018ANAAAAAAAAAA	SPRI PM Package 3.000 rpm, 18,5 kW	5.444 EUR
SPAA4A022ANAAAAAAAAAA	SPRI PM Package 3.000 rpm, 22 kW	6.716 EUR
SPAA4A030ANAAAAAAAAAA	SPRI PM Package 3.000 rpm, 30 kW	8.776 EUR
SPAA4A037ANAAAAAAAAAA	SPRI PM Package 3.000 rpm, 37 kW	9.701 EUR

### SPRI PM Package (Motor & Inverter & EMC Filter), 1.500 rpm, flange mount B5 motor - with IP00/NEMA1 inverter

Ürün Kodu	Açıklama	Liste Fiyatı
SPAF4A1P5BNBAAAAAAAAAA	SPRI PM Package 1.500 rpm, 1,5 kW	1.410 EUR
SPAF4A2P2BNBAAAAAAAAAA	SPRI PM Package 1.500 rpm, 2,2 kW	1.659 EUR
SPAF4A4P0BNBAAAAAAAAAA	SPRI PM Package 1.500 rpm, 4,0 kW	2.044 EUR
SPAF4A5P5BNBAAAAAAAAAA	SPRI PM Package 1.500 rpm, 5,5 kW	2.571 EUR
SPAF4A7P5BNDAAAAAAAAAA	SPRI PM Package 1.500 rpm, 7,5 kW	3.040 EUR
SPAF4A011BNBAAAAAAAAAA	SPRI PM Package 1.500 rpm, 11 kW	4.888 EUR
SPAF4A015BNBAAAAAAAAAA	SPRI PM Package 1.500 rpm, 15 kW	5.469 EUR
SPAF4A018BNBAAAAAAAAAA	SPRI PM Package 1.500 rpm, 18,5 kW	5.866 EUR
SPAA4A022BNBAAAAAAAAAA	SPRI PM Package 1.500 rpm, 22 kW	8.878 EUR
SPAA4A030BNBAAAAAAAAAA	SPRI PM Package 1.500 rpm, 30 kW	10.278 EUR
SPAA4A037BNBAAAAAAAAAA	SPRI PM Package 1.500 rpm, 37 kW	12.340 EUR

**SPRiPM Package (Motor & Inverter & EMC Filter), 3.000 rpm, flange mount B5 motor - with IP00/NEMA1 inverter**

Ürün Kodu	Açıklama	Liste Fiyatı
SPAF4A1P5ANBAAAAAAAAA	SPRiPM Package 3.000 rpm, 1,5 kW	1.373 EUR
SPAF4A2P2ANBAAAAAAAAA	SPRiPM Package 3.000 rpm, 2,2 kW	1.441 EUR
SPAF4A4P0ANBAAAAAAAAA	SPRiPM Package 3.000 rpm, 4,0 kW	1.667 EUR
SPAF4A5P5ANBAAAAAAAAA	SPRiPM Package 3.000 rpm, 5,5 kW	2.278 EUR
SPAF4A7P5ANBAAAAAAAAA	SPRiPM Package 3.000 rpm, 7,5 kW	2.726 EUR
SPAF4A011ANBAAAAAAAAA	SPRiPM Package 3.000 rpm, 11 kW	3.022 EUR
SPAF4A015ANDAAAAAAAAA	SPRiPM Package 3.000 rpm, 15 kW	3.724 EUR
SPAF4A018ANBAAAAAAAAA	SPRiPM Package 3.000 rpm, 18,5 kW	5.511 EUR
SPAA4A022ANBAAAAAAAAA	SPRiPM Package 3.000 rpm, 22 kW	6.793 EUR
SPAA4A030ANBAAAAAAAAA	SPRiPM Package 3.000 rpm, 30 kW	8.943 EUR
SPAA4A037ANBAAAAAAAAA	SPRiPM Package 3.000 rpm, 37 kW	9.873 EUR



**SPRiPM Package (Motor & Inverter & EMC Filter), 1.500 rpm, foot mount B3 motor - with IP54 inverter**

Ürün Kodu	Açıklama	Liste Fiyatı
SPAW4A022BNAAAAAAAAA	SPRiPM Package 1.500 rpm, 22 kW	10.736 EUR
SPAW4A030BNAAAAAAAAA	SPRiPM Package 1.500 rpm, 30 kW	13.122 EUR
SPAW4A037BNAAAAAAAAA	SPRiPM Package 1.500 rpm, 37 kW	16.405 EUR
SPAW4A045BNAAAAAAAAA	SPRiPM Package 1.500 rpm, 45 kW	19.315 EUR

**SPRiPM Package (Motor & Inverter & EMC Filter), 3.000 rpm, foot mount B3 motor - with IP54 inverter**

Ürün Kodu	Açıklama	Liste Fiyatı
SPAW4A022ANAAAAAAAAA	SPRiPM Package 3.000 rpm, 22 kW	8.743 EUR
SPAW4A030ANAAAAAAAAA	SPRiPM Package 3.000 rpm, 30 kW	11.800 EUR
SPAW4A037ANAAAAAAAAA	SPRiPM Package 3.000 rpm, 37 kW	14.064 EUR

**SPRiPM Package (Motor & Inverter & EMC Filter), 1.500 rpm, flange mount B5 motor - with IP54 inverter**

Ürün Kodu	Açıklama	Liste Fiyatı
SPAW4A022BNBAAAAAAAAA	SPRiPM Package 1.500 rpm, 22 kW	10.903 EUR
SPAW4A030BNBAAAAAAAAA	SPRiPM Package 1.500 rpm, 30 kW	13.301 EUR
SPAW4A037BNBAAAAAAAAA	SPRiPM Package 1.500 rpm, 37 kW	16.703 EUR

**SPRiPM Package (Motor & Inverter & EMC Filter), 3.000 rpm, flange mount B5 motor - with IP54 inverter**

Ürün Kodu	Açıklama	Liste Fiyatı
SPAW4A022ANBAAAAAAAAA	SPRiPM Package 3.000 rpm, 22 kW	8.821 EUR
SPAW4A030ANBAAAAAAAAA	SPRiPM Package 3.000 rpm, 30 kW	11.965 EUR
SPAW4A037ANBAAAAAAAAA	SPRiPM Package 3.000 rpm, 37 kW	14.239 EUR

## Options for A1000 Series

Ürün Kodu	Açıklama	Liste Fiyatı
EZZ021136F	NEMA1 Kit for Inverter A1000, T1000A 400V 58A	560 EUR
EZZ021136G	NEMA1 Kit for Inverter A1000, T1000A 400V 72A	270 EUR
EZZ021136H	NEMA1 Kit for Inverter A1000, T1000A 400V 88A, 103A	270 EUR
AI-A3	Analog Input card (3 inputs)	179 EUR
AO-A3	2 additional Analog Output	133 EUR
CDBR-4045D	400V Braking Transistor Unit 45kW	575 EUR
CDBR-4090D	400V Braking Transistor Unit 90kW	1.803 EUR
CDBR-4220D	400V Braking Transistor Unit 220kW	2.302 EUR
DI-A3	Digital Input (BCD Code)	109 EUR
DO-A3	Digital Output (6 open collector 2 relais)	109 EUR
EUOP-V11001	IP54/65 Operator Frame	25 EUR
EZZ020642A	Operator Attachment IP 20 with screws	24 EUR
EZZ020642B	Operator Attachment IP 20 with nuts	18 EUR
EZZ020800A	Heatsink external Attachment A1000 400V 5A	70 EUR
EZZ020800B	Heatsink external Attachment A1000 400V 7A, 9A,11A, 18A, 23A	70 EUR
EZZ020800C	Heatsink external Attachment A1000 400V 31A, 38A	77 EUR
EZZ020800D	Heatsink external Attachment A1000 400V 44A	83 EUR
EZZ021710A	Retrofit Attachment for CDBR-4030D, 4045D	36 EUR
EZZ021711A	External Heatsink Attachment for CDBR-4045D	45 EUR
JVOP-180	LCD Operator 1000 Series (standard in A1000 included)	133 EUR
JVOP-181	Copy unit w/USB converter	232 EUR
JVOP-182	LED Operator 1000 Series	63 EUR
PS-A10HB	Power Supply Unit 24VDC (400V)	187 EUR
SI-C3	Comm. Interface A1000 CCLink	259 EUR
SI-EL3	Comm. Interface A1000 Powerlink	558 EUR
SI-EN3	Comm. Interface A1000 EtherNet IP	333 EUR
SI-EM3	Comm. Interface A1000 Modbus TCP	356 EUR
SI-EM3D	Comm.Interface A1000 Dual Port Modbus TCP	534 EUR
SI-EP3	Comm. Interface A1000 ProfiNet	498 EUR
EUOP-SI-ES3	Comm. Interface A1000 EtherCAT	351 EUR
SI-ES3	Comm. Interface A1000 EtherCAT *1	357 EUR
SI-N3	Comm. Interface A1000 DeviceNET	169 EUR
SI-P3	Comm. Interface A1000 ProfibusDP	361 EUR
SI-S3	Comm. Interface A1000 CANopen	187 EUR
SI-T3	Comm. Interface A1000 Mechatrolink II	242 EUR
WV001-YEG	1m extension cable for remote Digital Operator	51 EUR
WV003-YEG	3m extension cable for remote Digital Operator	60 EUR

\*1: Note: The SI-ES option card will replace the EUOP-SI-ES3 card. Both cards will be available in parallel for a certain period of time. On the SI-ES3 card a few functions work in a different way than on the EUOP-SI-ES3 card. Therefore we recommend:

- not to mix SI-ES3 and EUOP-SI-ES3 cards in one project.
- use the SI-ES3, NOT EUOP-SI-ES3 for new projects.

Information on compatibility can be obtained from our technical support.

## EtherCAT Starter KIT Yaskawa & VIPA



Components of the EtherCAT Starter Kit:	
A	CPU 315SN/EC PLC
B	USB Stick with Software and Manuals
C	IM 053-1EC00 Communication Interface
D	2 EtherCAT Cables
E	Grounding Cable
F	Cables for USB Copy Unit
G	USB Copy Unit
H	V1000 EtherCAT Communication Option
I	V1000 Inverter Drive

### EtherCAT Starter Kit Yaskawa & VIPA

Ürün Kodu	Açıklama	NET FİYAT
800-5DK30	EtherCAT Starter Kit Yaskawa & VIPA *Fiyat Nettir*	1508 EUR

### Content

- 1x VIPA CPU 315SN/EC
- 1x VIPA IM 053EC - EtherCAT-Slave
- 1x VIPA CM 001 Potential Distributor 4xDC 24 V, 4xDC 0 V clamps
- 1x VIPA SM 021 Digital Input (DI 8xDC 24V)
- 1x VIPA SM 021 Digital Input (DI 4xDC 24V)
- 1x VIPA SM 022 Digital Output (DO 4xDC 24V, 0,5A)
- 1x VIPA SM 031 Analog Input (AI 2x12Bit, U)
- 1x VIPA SM 032 Analog Output (AO 2x12Bit, U)
- 1x YASKAWA V1000 Drive, 230V Single Phase, 1 A
- 1x YASKAWA EtherCAT option card for V1000
- 1x USB Converter/Copy unit incl. USB cable and connection cable to drive
- 1x USB stick (contents: Quick setup guide, EtherCAT Kit Flyer, Manuals, PC Software, Links)
- 2x EtherCAT cable 1m
- 1x Ethernet cable PC-CPU
- 1x DIN profile rail 35mm for SLIO components
- 1x Flyer SPEED7 Studio
- 1x License Key for SPEED7 Studio
- 1x Robust carrying case

## Resistors

### Resistors 40 % ED

Ürün Kodu	Açıklama	Liste Fiyatı
RH-0100W330	Braking Resistor 100W, 330Ohm; 40% ED	36 EUR
RH-0100W830	Braking Resistor 100W, 830Ohm; 40% ED	36 EUR
RH-0260W120	Braking Resistor 260W, 120Ohm; 40% ED	45 EUR
RH-0260W135	Braking Resistor 260W, 135Ohm; 40% ED	45 EUR
RH-0260W270	Braking Resistor 260W, 270Ohm; 40% ED	45 EUR
RH-0390W070	Braking Resistor 390W, 70Ohm; 40% ED	50 EUR
RH-0520W120	Braking Resistor 520W, 120Ohm; 40% ED	53 EUR
RH-0780W040	Braking Resistor 780W, 40Ohm; 40% ED	133 EUR
RH-1000W120	Braking Resistor 1000W, 120Ohm; 40% ED	149 EUR
RH-1560W040	Braking Resistor 1560W, 40Ohm; 40% ED	187 EUR
RH-2700W025	Braking Resistor 2700W, 25Ohm; 40% ED	268 EUR
RH-3700W025	Braking Resistor 3700W, 25Ohm; 40% ED	324 EUR
RH-4800W022	Braking Resistor 4800W, 22Ohm; 40% ED	414 EUR
RH-6000W022	Braking Resistor 6000W, 22Ohm; 40% ED	494 EUR
RH-7500W023	Braking Resistor 7500W, 23Ohm; 40% ED	557 EUR
RH-9600W015	Braking Resistor 9600W, 15Ohm; 40% ED	764 EUR

### Resistors 40 % ED with Thermosensor & UL

Ürün Kodu	Açıklama	Liste Fiyatı
RH-0100W330-UL-T	Braking Resistor 100W, 330Ohm; 40% ED with Thermosensor & UL	42 EUR
RH-0100W830-UL-T	Braking Resistor 100W, 830Ohm; 40% ED with Thermosensor & UL	42 EUR
RH-0260W135-UL-T	Braking Resistor 260W, 135Ohm; 40% ED with Thermosensor & UL	53 EUR
RH-0260W270-UL-T	Braking Resistor 260W, 270Ohm; 40% ED with Thermosensor & UL	53 EUR
RH-0390W070-UL-T	Braking Resistor 390W, 70Ohm; 40% ED with Thermosensor & UL	56 EUR
RH-0520W120-UL-T	Braking Resistor 520W, 120Ohm; 40% ED with Thermosensor & UL	60 EUR
RH-0780W040-UL-T	Braking Resistor 780W, 40Ohm; 40% ED with Thermosensor & UL	149 EUR
RH-1000W120-UL-T	Braking Resistor 1000W, 120Ohm; 40% ED with Thermosensor & UL	187 EUR
RH-1560W040-UL-T	Braking Resistor 1560W, 40Ohm; 40% ED with Thermosensor & UL	224 EUR
RH-2700W025-UL-T	Braking Resistor 2700W, 25Ohm; 40% ED with Thermosensor & UL	306 EUR
RH-3700W025-UL-T	Braking Resistor 3700W, 25Ohm; 40% ED with Thermosensor & UL	361 EUR
RH-4800W022-UL-T	Braking Resistor 4800W, 22Ohm; 40% ED with Thermosensor & UL	452 EUR
RH-6000W022-UL-T	Braking Resistor 6000W, 22Ohm; 40% ED with Thermosensor & UL	533 EUR
RH-7500W023-UL-T	Braking Resistor 7500W, 23Ohm; 40% ED with Thermosensor & UL	595 EUR
RH-9600W015-UL-T	Braking Resistor 9600W, 15Ohm; 40% ED with Thermosensor & UL	803 EUR

### Resistors 10 % ED

Ürün Kodu	Açıklama	Liste Fiyatı
RH-0780W040-10	Braking Resistor 780W, 40Ohm; 10% ED	45 EUR
RH-1560W040-10	Braking Resistor 1560W, 40Ohm; 10% ED	50 EUR
RH-4800W022-10	Braking Resistor 4800W, 22Ohm; 10% ED	187 EUR
RH-6000W022-10	Braking Resistor 6000W, 22Ohm; 10% ED	193 EUR
RH-9600W015-10	Braking Resistor 9600W, 15Ohm; 10% ED	324 EUR
RH-29000W3P8-10	Braking Resistor 29kW, 3,80Ohm; 10% ED	744 EUR
RH-38500W3P8-10	Braking Resistor 38,50kW, 3,80Ohm; 10% ED	786 EUR
RH-48000W3P8-10	Braking Resistor 48kW, 3,80Ohm; 10% ED	887 EUR

## Resistors 10 % ED with Thermosensor & UL

Ürün Kodu	Açıklama	Liste Fiyatı
RH-0780W040-10-UL-T	Braking Resistor 780W, 40Ohm; 10% ED with Thermosensor & UL	53 EUR
RH-1560W040-10-UL-T	Braking Resistor 1560W, 40Ohm; 10% ED with Thermosensor & UL	56 EUR
RH-4800W022-10-UL-T	Braking Resistor 4800W, 22Ohm; 10% ED with Thermosensor & UL	224 EUR
RH-6000W022-10-UL-T	Braking Resistor 6000W, 22Ohm; 10% ED with Thermosensor & UL	232 EUR
RH-9600W015-10-UL-T	Braking Resistor 9600W, 15Ohm; 10% ED with Thermosensor & UL	361 EUR
RH-29000W3P8-10-UL-T	Braking Resistor 29kW, 3,80Ohm; 10% ED with Thermosensor & UL	758 EUR
RH-38500W3P8-10-UL-T	Braking Resistor 38,50kW, 3,80Ohm; 10% ED with Thermosensor & UL	800 EUR
RH-48000W3P8-10-UL-T	Braking Resistor 48kW, 3,80Ohm; 10% ED with Thermosensor & UL	902 EUR

## Resistors 3 % ED

Ürün Kodu	Açıklama	Liste Fiyatı
ERF-150WJ101	Braking Resistor 150W, 100Ohm	27 EUR
ERF-150WJ201	Braking Resistor 150W, 200Ohm	27 EUR
ERF-150WJ301	Braking Resistor 150W, 300Ohm	27 EUR
ERF-150WJ401	Braking Resistor 150W, 400Ohm	27 EUR
ERF-150WJ620	Braking Resistor 150W, 620Ohm	27 EUR
ERF-150WJ700	Braking Resistor 150W, 700Ohm	27 EUR
ERF-150WJ751	Braking Resistor 150W, 750Ohm	27 EUR

Red colour values indicate low and maybe critical braking torque values

### Braking Resistors

Inverter Type		Braking Unit	HD			ND			Minimum Resistor	
Model	Resistor 40% ED		Resistor 10% ED	Braking Torque	Braking Unit	Resistor 40% ED	Resistor 10% ED	Braking Torque		
		CDBR-	%			CDBR-	%			
A1000 400V	CIMR-AC4A0002xAA	Built-in	RH-0100W830	RH-0100W830	178	Built-in	RH-0100W330	RH-0100W330	239	96
	CIMR-AC4A0004xAA		RH-0100W330	RH-0100W330	239		RH-0260W270	RH-0260W270	146	96
	CIMR-AC4A0005xAA		RH-0260W270	RH-0260W270	146		RH-0520W120	RH-0520W120	99	64
	CIMR-AC4A0007xAA		RH-0520W120	RH-0520W120	99				164	64
	CIMR-AC4A0009xAA				164				133	32
	CIMR-AC4A0011xAA		133	268	32					
	CIMR-AC4A0018xAA		RH-0780W040	RH-0780W040-10	268		RH-0780W40	RH-0780W040-10	197	32
	CIMR-AC4A0023xAA		RH-1560W040	RH-1560W040-10	197				134	32
	CIMR-AC4A0031xAA				134				98	20
	CIMR-AC4A0038xAA		RH-4800W022	RH-4800W022-10	179				RH-4800W22	RH-4800W022-10
	CIMR-AC4A0044xAA	RH-6000W022	RH-6000W022-10	138	122	19				
	CIMR-AC4A0058xAA			122	89	19				
	CIMR-AC4A0072xAA	89	73	19						
	CIMR-AC4A0088xAA	4045B	RH-9600W015	RH-9600W015-10	106	4045B	RH-9600W015	RH-9600W015-10	88	13
	CIMR-AC4A0103xAA	2 x 4030B	2 x RH-6000W022	2 x RH-6000W022-10	98		2 x RH6000W022	2 x RH-6000W022-10	72	19
	CIMR-AC4A0139xAA	2 x 4045B	2 x RH9600W015	2 x RH-9600W015-10	105	2 x 4045B	2 x RH9600W015	2 x RH-9600W015-10	88	13
	CIMR-AC4A0165xAA	2 x 4045B	2 x RH9600W015	2 x RH-9600W015-10	88	4220B	RH-29000W3P8-10	101	13/3.2	
	CIMR-AC4A0208xAA	2 x 4045B	2 x RH-9600W015	2 x RH-9600W015-10	100		RH-38500W3P8-10	112	3.2	
	CIMR-AC4A0250xAA	4220B		RH-29000W3P8-10	112		RH-38500W3P8-10	98	3.2	
	CIMR-AC4A0296xAA			92	80		3.2			
CIMR-AC4A0362xAA	86			84	3.2					
CIMR-AC4A0414xAA	67			74	3.2					
CIMR-AC4A0515xAA	2 x 4220B	2 x RH-29000W3P8-10	2 x RH-29000W3P8-10	99	2 x 4220B		2 x RH-38500W3P8-10	84	3.2	

Note: the order code for the resistors consists of the rated power and the resistance value of the resistor:  
Example: RH0260W270 260W, 270 Ohms

10% ED : 120 s cycle time (t) and 12 s switch on time (ton)  
40% ED : 120 s cycle time (t) and 48 s switch on time (ton)  
Attention :  
10% ED: 300 s (t) cycle and 30 s switch on time (ton)  
In case of question please contact Yaskawa

Red colour values indicate low and maybe critical braking torque values

### Braking Resistors

Inverter Type		Braking Unit	HD			ND			Minimum Resistor	
Model	Resistor 40% ED		Resistor 10% ED	Braking Torque	Braking Unit	Resistor 40% ED	Resistor 10% ED	Braking Torque		
		CDBR-	%			CDBR-	%			
200V, 1 ph V1000 and J1000	CIMR-VCBA0001BAA	Built-in	RH-0100W830	RH-0100W830	196	Built-in	RH0100W330	RH0100W330	247	300
	CIMR-VCBA0002BAA		RH-0100W330	RH-0100W330	98		RH0260W270	RH0260W270	123	300
	CIMR-VCBA0003BAA		RH-0260W270	RH-0260W270	151		RH0260W135	RH0260W135	80	200
CIMR-VCBA0006BAA	RH-0260W135		RH-0260W135	161	RH0390W070		RH0390W070	80	120	
CIMR-VCBA0010BAA	RH-0390W070		RH-0390W070	155				106	60	
CIMR-VCBA0012BAA	RH-0780W040		RH-0780W040-10	106				78	60	
colerm 2010: F	CIMR-VCBA0018BAA		RH-0780W040	RH-0780W040-10	110	RH780W040	RH-0780W040-10	136	32	
400V V1000 and J1000	CIMR-VC4A0001BAA	Built-in	RH-0100W830	RH-0100W830	317	Built-in	RH-0100W830	RH-0100W830	178	750
	CIMR-VC4A0002BAA		RH-0100W330	RH-0100W330	159		RH-0100W830	RH-0100W830	95	750
	CIMR-VC4A0004BAA		RH-0260W270	RH-0260W270	85		RH-0260W270	RH-0260W270	47	510
	CIMR-VC4A0005BAA		RH-0520W120	RH-0520W120	130		RH-0520W120	RH-0520W120	99	240
	CIMR-VC4A0007BAA		RH-0520W120	RH-0520W120	89		RH-0520W120	RH-0520W120	73	200
	CIMR-VC4A0009BAA		RH-0780W040	RH-0780W040-10	119		RH-0520W120	RH-0520W120	133	100
	CIMR-VC4A0011BAA		RH-0780W040	RH-0780W040-10	146		RH-0780W040	RH-0780W040-10	89	100
	CIMR-VC4A0018FAA		RH-1560W040	RH-1560W040-10	239		RH-0780W040	RH-0780W040-10	197	32
	CIMR-VC4A0023FAA		RH-1560W040	RH-1560W040-10	175		RH-1560W040	RH-1560W040-10	134	32
	CIMR-VC4A0031FAA		RH-4800W022	RH-4800W022-10	120		RH-1560W040	RH-1560W040-10	98	20
CIMR-VC4A0038FAA			159	RH-4800W022	RH-4800W022-10	145	20			
200V 3ph V1000 and J1000	CIMR-VC2A0001BAA	Built-in	RH-0100W830	RH-0100W830	196	Built-in	RH-0100W330	RH-0100W330	247	300
	CIMR-VC2A0002BAA		RH-0100W330	RH-0100W330	247		RH-0260W270	RH-0260W270	123	300
	CIMR-VC2A0004BAA		RH-0260W270	RH-0260W270	151		RH-0260W135	RH-0260W135	80	200
	CIMR-VC2A0006BAA		RH-0260W135	RH-0260W135	161		RH-0260W135	RH-0260W135	110	120
	CIMR-VC2A0008BAA		RH-0260W120	RH-0260W120	123				155	60
	CIMR-VC2A0010BAA		RH-0390W070	RH-0390W070	155		RH-0390W070	RH-0390W070	106	60
	CIMR-VC2A0012BAA		RH-0780W040	RH-0780W040-10	106				78	60
	CIMR-VC2A0018BAA		RH-0780W040	RH-0780W040-10	136		RH-0780W040	RH-0780W040-10	110	32
	CIMR-VC2A0020BAA		RH-1560W040	RH-1560W040-10	110		RH-0780W040	RH-0780W040-10	74	32
	CIMR-VC2A0030FAA		RH-9600W015	RH-9600W015-10	74		RH-1560W040	RH-1560W040-10	121	9.6
CIMR-VC2A0040FAA			145	RH-9600W015	RH-9600W015-10	99	9.6			
CIMR-VC2A0056FAA			99			72	9.6			
CIMR-VC2A0069FAA			72			59	9.6			

Note: the order code for the resistors consists of the rated power and the resistance value of the resistor:  
Example: RH0260W270 260W, 270 Ohms

10% ED : 120 s cycle time (t) and 12 s switch on time (ton)  
40% ED : 120 s cycle time (t) and 48 s switch on time (ton)  
In case of question please contact Yaskawa

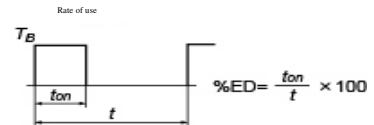



## Braking Resistors

Inverter Type		HD			ND			Minimum Resistor	
Model	Braking Unit CDBR-	Resistor 40% ED	Resistor 10% ED	Braking Unit CDBR-	Resistor 40% ED	Resistor 10% ED			
GA700 400V	GA70C4002BBA	Built-in	RH-0260W270	RH-0260W270	Built-in	RH-0260W270	RH-0260W270	165	
	GA70C4004BBA							165	
	GA70C4005BBA							110	
	GA70C4007BBA							110	
	GA70C4009BBA							55	
	GA70C4012BBA							55	
	GA70C4018BBA		32						
	GA70C4023BBA		32						
	GA70C4031BBA		20						
	GA70C4038BBA		20						
	GA70C4044BBA		19,2						
	GA70C4060BBA		19,2						
	GA70C4075BBA	19,2							
	GA70C4089BBA	10,6							
	GA70C4103BBA	8,7							
	GA70C4140BBA	2 x RH-6000W022	2 x RH-6000W022-10	2 x RH-6000W022	2 x RH-6000W022-10	7,2			
	GA70C4168BBA	2 x RH-9600W015	2 x RH-9600W015-10	2 x RH-9600W015	2 x RH-9600W015-10	5,2			
	GA70C4208BBA	2 x 4045D	2 x RH-9600W015	2 x RH-9600W015-10	2 x 4045D	2 x RH-9600W015	2 x RH-9600W015-10	13	
	GA70C4250BBA	4220D			4220D		RH-29000W3P8-10		3,2
	GA70C4296BBA								
GA70C4371BAA									
GA70C4414BAA									
GA70C4453BAA									
GA70C4569BAA									
GA70C4675BAA									
GA70C4726BAA									
GA70C4810BAA									
GA70C4930BAA									
GA70C4H12BAA									

not assigned yet

Note: the order code for the resistors consists of the rated power and the resistance value of the resistor:

Example: RH0260W270 260W, 270 Ohms

10% ED : 120 s cycle time (t) and 1

40% ED : 120 s cycle time (t) and 4

Attention :



10% ED: 300 s (t) cycle and 30 s switch on time (ton)

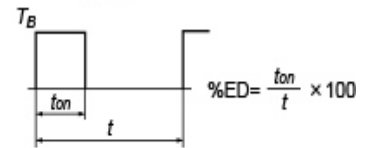

In case of question please contact Yaskawa



Rate of use







## Frequency Converter (Drives)



<b>D1</b>		Basic Training – Inverter
1 	Understanding the basics and applications of the frequency converter. Product overview	
4-8 		
	560€ / Person incl. lunch	
ZG	Plant and machine builders System integrators	
VS	Technical understanding	



<b>D2</b>		Product Training – Inverter
2 	Being able to make the right selection of products and the appropriate options Standard commissioning	
4-8 		
	1.090€ / Person incl. lunch	
ZG	Plant and machine builders System integrators	
VS	Technical understanding	

<b>D3</b>		Technical Training – Inverter
3 	Commissioning and independent creation of complex configurations. Optimization of the drive functions	
4-8 		
	1.590€ / Person incl. lunch	
ZG	Plant and machine builders System integrators commissioning	
VS	Product training – Inverter	

<b>D4</b>		DriveWorksEZ Pro Training
1 	Function and application of the software for graphical project planning of functional extensions.	
4-8 	DriveWorksEZ Pro	
	560€ / Person incl. lunch	
ZG	Plant and machine builders System integrators	
VS	Technical training – Inverter	

<b>D5</b>		Customer-Specific Training upon request
a.A. 	Customer training in accordance with agreement and customer requirements	
4-7 		
	1.600€ / day	
ZG	Plant and machine builders System integrators	
VS	Technical training – Inverter	

<b>D6</b>		Maintenance Training – Inverter
2 	Design of the inverter.	
4-8 	Replacing maintenance parts. Parameter backup. Trouble shooting	
	1.090€ / Person incl. lunch	
ZG	Maintenance staff	
VS	Electronic basics	

<b>D7</b>		Application Training – Inverter
2 	Design of the inverter. Configure the required parameters. Connection and wiring.	
4-8 	DriveWizardPlus	
	1.090€ / Person incl. lunch	
ZG	Plant and machine builders System integrators	
VS	Electronic basics	

## Machine Control (Motion Controller IEC)

<b>C1</b>		Product Training
1	4-8	Understanding the basics and application fields of the IEC machine control. Being able to make the right selection of products and the appropriate options
		560€ / Person incl. lunch
ZG		Facility and machine builders System integrators
VS		Technical understanding

<b>C3</b>		Advanced Technical Training
3	4-8	Commissioning and independent creation of more complex programmes and optimization of IEC machine controllers. Obtain in-depth knowledge. Parametrization and optimization of servo drives in connection with IEC machine controls
		1.590€ / Person incl. lunch
ZG		Facility and machine builders System integrators
VS		Product training, technical basic training

<b>C2</b>		Training of Technical Basics
2	4-8	Commissioning and independent creation of simple programmes and optimization of IEC machine controllers.
		1.590€ / Person incl. lunch
ZG		Plant and machine builders System integrators
VS		Producttraining

<b>C4</b>		Machine Control Complete Training
5	4-8	Commissioning and independent creating of programmes with the MPiEc machine control system.
		Commissioning and optimization of servo-drives in conjunction with the MPiEc machine control system 2.690€ / Person incl. lunch
ZG		Plant and machine builders System integrators
VS		Producttraining

## Servo-Drive Technology (Servo)

<b>SV1</b>		Basic Training – Servo
0.5	4-8	Understanding the basics of the technology and application areas of servo drives. Product overview.
		300€ / Person incl. lunch
ZG		Facility and machine builders System integrators
VS		Technical understanding

<b>SV3</b>		Technical Training – Servo
3	4-8	Commissioning and independent creation of complex configurations of servo drives.
		1.590€ / Person incl. lunch
ZG		Facility and machine builders System integrators
VS		Basic training – Servo Product training – Servo

<b>SV2</b>		Product Training – Servo
1	4-8	Being able to make the right choice of servo products.
		560€ / Person incl. lunch
ZG		Plant and machine builders System integrators
VS		Basic training